



**HELUKABEL®**



 Edition 11

# DATA, NETWORK & BUS TECHNOLOGY

**HELUCOM®**

**HELUKAT®**

[helukabel-group.com](http://helukabel-group.com)



## ■ INTRODUCTION

The market for automation is growing, and with it the networking of production structures. In the future, communication will not only take place from desk to machine; the increasingly digital networking will make possible the automated exchange of information from machine to machine. Networking production via the internet makes it possible to globalise value-added chains, with production that independently responds to unplanned events.

The challenge to transmit ever higher quantities of data faster and faster is also present in other areas of life. Municipalities face the challenge of expanding their broadband infrastructure and providing a reliable supply, even in rural areas. High-performance broadband networks are a prerequisite for economic growth and have now become relevant for many applications and areas of day-to-day life.

The challenges are quite diverse, but just as diverse are the solutions presented in this, Issue 11 of this catalogue. New additions to our range of products include microduct fibre optic cable, optical fibres for PROFINet and PROFIBUS systems, PROFINet A, B, C as FRNC versions, as well as drag chain capable ETHERNET category 6A and category 7 cables. Discover our wide range of products. We welcome your questions and feedback.



Helmut Luksch,  
Chief Executive Officer, HELUKABEL® GmbH



# ■ HELUKABEL® DATA, NETWORK & BUS TECHNOLOGY

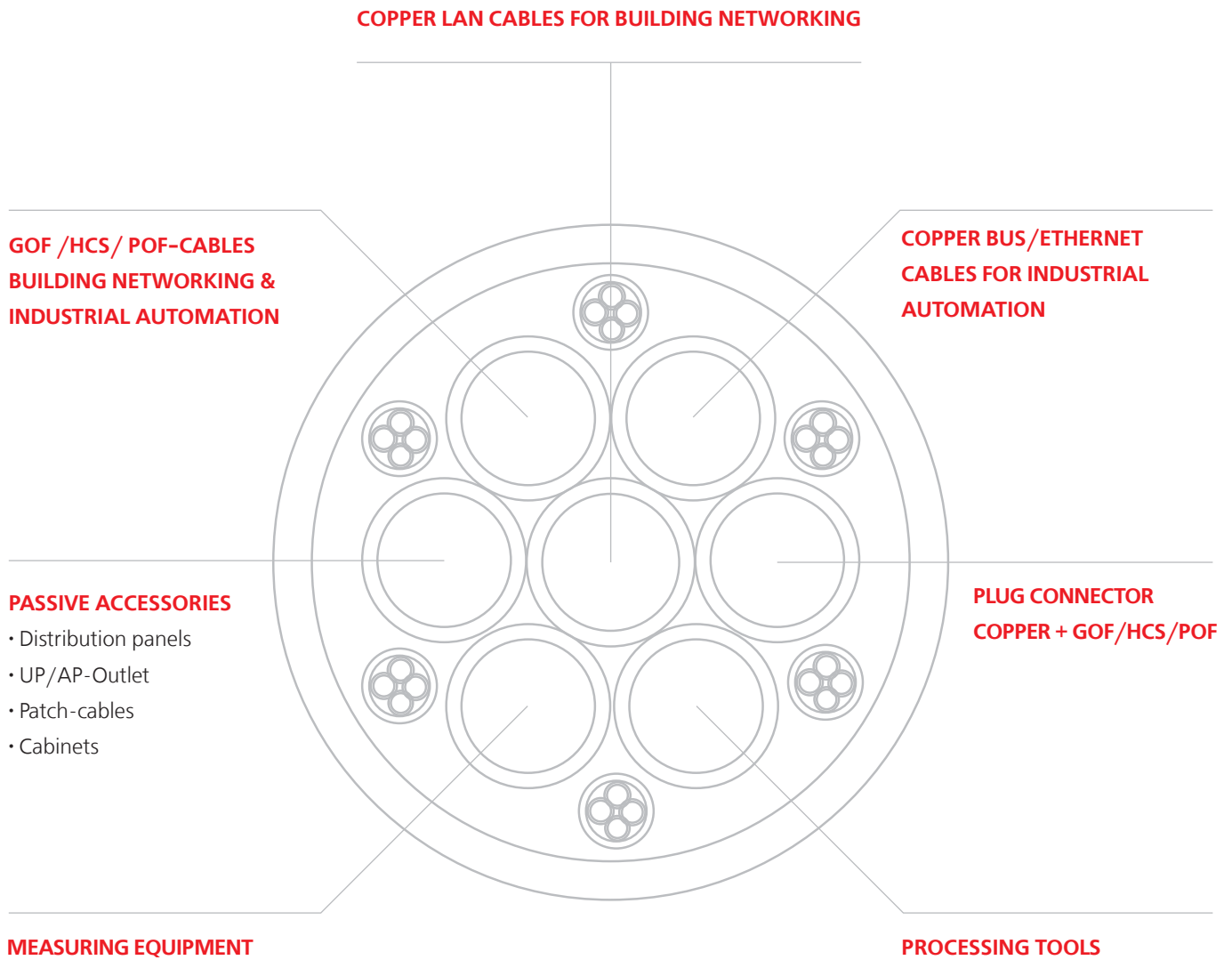

# ■ TABLE OF CONTENTS

<b>INTRODUCTION</b> .....	<b>1</b>
Research & development.....	4
Production .....	6
Logistics.....	8
Certified products are products you can trust.....	11
Product finder HELUCOM® - Fibre Optic Systems .....	12
Product finder HELUKAT® - Copper Data Systems .....	16
Product finder HELUKABEL® - Bus Systems .....	20
Always close to you - 41 locations in 24 countries .....	24
Chapter overview.....	27
Chapter Description .....	28
<b>FIBRE OPTIC CABLES</b> .....	<b>32</b>
<b>COPPER DATA CABLES</b> .....	<b>88</b>
<b>BUS-CABLES</b> .....	<b>126</b>
<b>COPPER DATA CONNECTION TECHNICS</b> .....	<b>228</b>
<b>FIBRE OPTIC CONNECTION TECHNICS</b> .....	<b>288</b>
<b>NETWORK SYSTEM CABINETS</b> .....	<b>330</b>
<b>MEASUREMENT &amp; PROCESSING TECHNICS</b> .....	<b>344</b>
<b>ACTIVE COMPONENTS</b> .....	<b>360</b>
<b>SERVICES</b> .....	<b>364</b>
<b>TECHNICAL INFORMATION</b> .....	<b>368</b>
Norm-Glossary .....	418
Glossary.....	421
Part Number Index.....	438
Notes.....	443



## ■ RESEARCH & DEVELOPMENT

We develop optimal, tailored cable solutions for our customers.



Torsion test apparatus

### Our test facilities:

- Test systems for bending and torsion requirements
- Drag chain test systems with movement distances of 1 m, 3 m, 5 m, 6 m, 18 m, and 40 m
- Fire testing systems
- Abrasion testing systems
- Torsion test tower for wind turbine cables
- Aging ovens in accordance with UL, VDE, CSA, HAR, TÜV & CCC

Research and development are the foundation of our work and are an important engine for growth. In interdisciplinary teams we continuously push the boundaries to enhance our products and develop solutions to meet the latest technological demands. Moreover, we value our customer interactions and partnerships with regional colleges and research institutes to stay on top of emerging technologies.

The materials that we use are an important starting point of our work. In this regard, we place as much emphasis on searching for and utilizing new materials, as we do on manufacturing our plastic mixtures (granulates) ourselves, and influencing the improvement of technical characteristics, such as oil-resistance, temperature range or chemical compatibility. Moreover, we are capable of pulling a majority of the copper ourselves, thus ensuring a uniform,

high-quality product relative to properties and workmanship.

With continuous optimization of our manufacturing processes and systems we take into consideration both efficient and economical production, and the complex requirements of various applications (such as cables for industrial robots or for applications under cleanroom conditions) into account.

A crucial stage in the development process of our products is the work done at our Test Center. For example, cables suitable for drag chain implementation, can be tested using equipment that accelerates cables up to 10 g.

Temperature ranges from  $-50^{\circ}$  to  $+250^{\circ}$  are simulated in a special climate-controlled environment so that drag chain cables can be tested for series production readiness in applications such as refrigerated warehouses or steel mills.



Drag chain test system





## ■ PRODUCTION

We specialize in the production of high-quality cables and wires.

Using the latest production methods, our two German plants manufacture approximately one million kilometers of conductors each year (= 77 times around the world). More than 300 qualified employees are specialized in the production of high-quality standard and custom cables. Through the use of the latest materials and collaboration with international test institutes, we drive innovation in the areas of automation, data technology, building system technology, and renewable energy.

Since 2014, in a 7,000 m<sup>2</sup> facility in the Chinese city of Taicang (approx. 50 km northwest of Shanghai) HELUKABEL® has been producing cable and wires, primarily for the Asian market. As is with our German plants, the focus is on high-quality, flexible and highly-flexible cables and wires that are manufactured in accordance with Chinese and international standards. The use of flexible manufacturing cells enable short delivery times.



Braiding machine

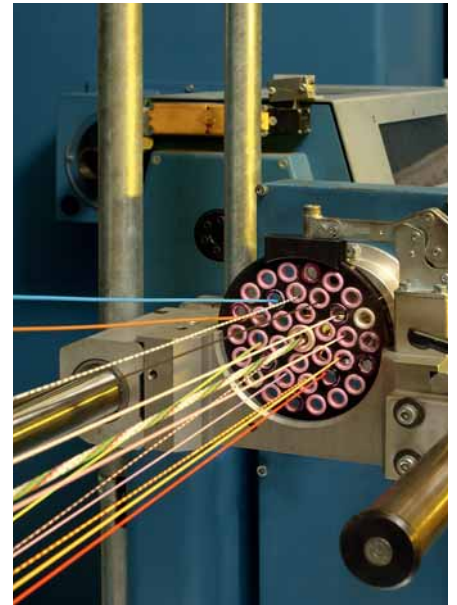

Stranding machine

Our production in numbers:

- 40,000 m<sup>2</sup> production area
- 23 extruder systems
- 19 stranding machines
- 50 braiding machines
- Cables & wires from 0.05 to 1,000 mm<sup>2</sup> (30 AWG to 2,000 kcmil)
- Manufacturing in accordance with: VDE, EAC (GOST-R), UL, CSA, HAR, CCC, Germanischer Lloyd, TÜV or customer specification



## ■ LOGISTICS

Redefining logistics in the cable industry.

### INDUSTRIAL CABLE

#### Our logistics center – Hemmingen/Stuttgart

- 40,500 Euro-pallet racks
- 16 aisles with 16 storage and retrieval devices
- 35,900 bin locations in the automatic small parts warehouse with a capacity of 1,000 bins per hour
- 670 storage spaces in the heavy load warehouse with max. reels of 4,000 kg and 2.20 m diameter
- 2 km conveyor line for pallets
- Conveyor connects direct to the cable-cutting machines
- Manual processes reduced to merely packing

### INFRASTRUCTURE CABLES

#### Our logistics center – Neuenhagen/Berlin

- 11,000 cable reels in stock
- Automatic processing of reels up to 2.80 m Ø and 10 t
- 10 rewinding machines
- Cut to length with state-of-the-art 1,200 mm<sup>2</sup> cutting tools
- 24-hr delivery is possible

At its corporate headquarters in the Swabian town of Hemmingen/Stuttgart, HELUKABEL® operates Europe's largest distribution center for cables and wires. Here a majority of the more than 33,000 products are located in a storage area of 160,000 m<sup>2</sup>. Through the use of state-of-the-art conveyor and control technology, more than 1,000 orders can be picked and dispatched daily to destinations around the world.

Neuenhagen/Berlin is the central warehouse location for underground, medium-voltage, and other infrastructure cables. Storage capacities of more than 5,000 m<sup>2</sup> (indoor) and 50,000 m<sup>2</sup> (outdoor) enable fast delivery of cable, configured from 1 – 30 kV, to construction sites and major projects. The patented heavy-load cable-cutting machines with a load capacity of more than 10 tons are the largest of their kind in Germany.

The new logistics center at the Taicang (Shanghai, China) production facility serves as a product distribution hub for the Asian market, and offers incredible advantages, particularly for servicing time- and volume-critical customer projects.



Heavy-load, cable-cutting facility



Small parts warehouse



**HELUKABEL®**

**HELUKAT®**

**HELUCOM®**

**HELUKAT®**  
CONNECTING SYSTEMS

**HELUCOM®**  
CONNECTING SYSTEMS

**HELUKAT®**  
CONNECTING SYSTEMS INDUSTRY

**HELUCOM®**  
CONNECTING SYSTEMS INDUSTRY



# CERTIFIED PRODUCTS ARE PRODUCTS YOU CAN TRUST

## Independently and continuously audited quality.

The certification of our products is proof of their superior quality. Product certificates for our products are issued by independent institutions on the basis of applicable performance tests. The certificates are required for use of the product in certain markets or areas of application.



# Product finder HELUCOM® Fibre Optic systems

Installation area	Application	Kind of processing	Fibre Type	Pulling type*	Tensile strength up to N*	Number of fibres					
Inside	fixed	Splicing	G50/ G62,5/ E9	Manual pulling	1200	4 - 12					
					3000	24 - 60					
	flexible	Direct pre-assembling	G50/ G62,5/ E9	Manual pulling	400	2					
					400	1 - 2					
					500	4 - 8					
					800	10 - 12					
					1200	4					
					1200	4					
					1500	2 - 8					
					2400	12 - 24					
					600	2					
					800	4					
	800	2									
	800	2									
100	2										
100	2										
100	2										
140	1 - 2										
high flexible		G50/ G62,5/ E9	Manual pulling	650	2 - 8						
				4800	4 - 12						
Inside/outside	fixed	Splicing	G50/ G62,5/ E9	Manual pulling	700	4 - 12					
					1000	4 - 12					
					1500	4 - 24					
		Blowing in*/ Manual pulling		2500	4 - 24						
				2700	24 - 72						
				3000	84 - 96						
	flexible high flexible	Direct pre-assembling/Splicing	G50 G50 OM4 G50 E9 G50/ G62,5/ E9 G50	Manual pulling	500	2					
					500	2					
					1000	2					
					1000	4					
					3000	4 - 12					
					800	2					
					Outside	fixed	Direct pre-assembling/Splicing	G50 G50/ G62,5/ E9 K200/230	Manual pulling	500	2
										800	2
1200	4										
1500	2										
Splicing	E9 G652.D + G657.A1	Blowing in*/ Manual pulling	180	4 - 12							
			700	4 - 72							
			1500	84 - 288							
			2500	12 - 72							
			2500	12 - 60							
	E9	Manual pulling	2700	12 - 60							
			3100	12 - 144							
			4100	12 - 144							
			9000	12 - 144							
			11100	12 - 144							
G50/ G62,5/ E9	Splicing	Blowing in*/ Manual pulling	16000	12 - 144							
			35000	12 - 144							
			1500	4 - 24							
	Blowing in*/ Manual pulling	Manual pulling	1500	2 - 24							
			1500	2 - 24							
			2500	24 - 72							
		Blowing in*/ Manual pulling	2700	2 - 24							
			2600	2 - 4							
			2700	2 - 72							
Blowing in*/ Manual pulling		2700	2 - 72								
		2700	2 - 72								
		2700	2 - 72								
		2700	84 - 144								
		2700	24 - 72								
		3000	84 - 144								
		3000	84 - 144								
		3000	84 - 144								
3500	84 - 144										

\* Note the information of the Blowing jet

\* = Tensile strength up to N

Cable type	Application	Page
I-D(ZN)H	Floor- and Building wiring	37
I-D(ZN)H	Floor- and Building wiring	37
AT-VYY	Industry wiring (Patch Cables)	74
I-VH	Device- and Floor wiring (Patch Cables)	34
I-V(ZN)H	Floor- and Building wiring	36
I-V(ZN)H	Floor- and Building wiring	36
AT-V(ZN)YY	Industry wiring (Control Level)	66
A-V(ZN)Y	Industry wiring (Control Level, Monitoring)	64
I-V(ZN)HH	Floor- and Building wiring	35
I-V(ZN)HH	Floor- and Building wiring	35
I-VHH	Device- and Floor wiring (Patch Cables)	34
AT-V(ZN)HH	Industry wiring (Patch Cables)	78
I-V(ZN)Y11Y	Industry wiring (Control Level)	77
I-V(ZN)YY	Industry wiring (Control Level)	76
I-V4Y(ZN)11Y, rot	Industry automation and cabinet wiring	84
I-V4Y(ZN)Y, grün	PROFInet B Kommunikation	82
I-V4Y(ZN)11Y, violett	Profibus Communication	83
I-V2Y	Industry automation and cabinet wiring	81
A-V(ZN)11Y	Industry wiring (Control Level, Monitoring)	63
AT-V(ZN)H(ZN)11Y	Industry wiring (Control Level, Monitoring)	65
AT-V(ZN)Y(ZN)Y	Industry wiring (Control Level, Monitoring)	65
I-V2Y(ZN)11Y, grün	PROFInet C Communication	82
I-V2Y(ZN)11Y, rot	Industry wiring (Impuls and Control Level)	81
A/I-D(ZN)BH(SR)H FS90	Data Communication, Monitoring security relevant areas (Tunnels,...)	43
A-DQ(ZN)BH FS30	Data Communication, Monitoring security relevant areas (Tunnels,...)	42
A/I-DQ(ZN)BH, zentral pact	Floor-, Building- and Campus wiring	39
A/I-DQ(ZN)BH, zentral	Floor-, Building- and Campus wiring	40
A/I-DQ(ZN)BH, verseilt	Floor-, Building- and Campus wiring	41
A/I-DQ(ZN)BH, verseilt	Floor-, Building- and Campus wiring	41
AT-W(ZN)H(ZN)H	PROFInet + Profibus wiring inside/outside	70
AT-W(ZN)H(ZN)H	PROFInet + Profibus wiring inside/outside	70
AT-V(ZN)H(ZN)BH	PROFInet + Profibus wiring inside/outside	72
AT-V(ZN)H(ZN)BH	PROFInet + Profibus wiring inside/outside	68
A/I-VQ(ZN)BH	Floor-, Building- and Campus wiring	38
AT-W(ZN)Y(ZN)11Y	PROFInet + Profibus wiring inside/outside	71
AT-W(ZN)YY	PROFInet + Profibus wiring outside	69
AT-WQ(ZN)Y(ZN)B2Y	PROFInet + Profibus wiring outside	73
AT-V(ZN)HH(BN)2Y	Industry wiring, outside	67
AT-VQH(ZN)B2Y	Industry wiring, outside	79
A-DQ2Y, Microduct zentral	Campus- and Roadway wiring (public communication,...)	54
A-DQ2Y, Microduct verseilt	Campus- and Roadway wiring (public communication,...)	55
A-DQ2Y, Microduct verseilt	Campus- and Roadway wiring (public communication,...)	55
A-DSF(L)(ZN)2Y	Campus wiring (Signal wiring of roadways,...)	60
A-DF(ZN)2Y(SR)2Y	Campus wiring with extrem rodent attacks	57
A-DF(ZN)2Y(SR)2Y	Campus wiring with extrem rodent attacks (ARCOR Spezifications)	58
ADSS 6L	Areal wiring	61
ADSS 9L	Areal wiring	61
ADSS 9	Areal wiring	62
ADSS 16L	Areal wiring	61
ADSS 16	Areal wiring	62
ADSS 35	Areal wiring	62
A-DQ(ZN)(SR)2Y	Campus wiring with extrem rodent attacks	56
A-DQ(ZN)2Y, zentral	Campus wiring	44
A-DQ(ZN)B2Y, zentral pact	Campus wiring	46
A-DQ(ZN)2Y, verseilt	Campus wiring	45
A-DQ(ZN)B2Y, zentral	Campus wiring	47
A-DSQ(ZN)B2Y	Campus wiring (coffer-dams,...)	59
A-DF(ZN)2Y	Campus wiring	51
A-DF(ZN)2Y4Y	Campus wiring	53
A-DF(ZN)B2Y	Campus wiring	52
A-DQ(ZN)2Y, verseilt	Campus wiring	45
A-DQ(ZN)B2Y, verseilt	Campus wiring	48
A-DF(ZN)2Y	Campus wiring	51
A-DF(ZN)2Y4Y	Campus wiring	53
A-DF(ZN)B2Y	Campus wiring	52
A-DQ(ZN)B2Y, verseilt	Campus wiring	48
A-DSF(L)(ZN)2Y	Campus wiring (Signal wiring of roadways,...)	60

Subject to technical alternations.

If you have technical questions, please check the technical information at page 368 or contact our expert advisors from the Department data, network and bus technology.

Accessories			
Plug	Splice Boxes	Jumper Cables	Processing Technic
Page	Page	Page	Page
303	298	306/307	from 350
		306/307	
		-	
303	298	306/307	
303/328	298/321/322	306/307/327	
	-	327	
	-		
328	-	326	
	-		
	-		
303	298	306/307	
328	-	326	
	-		
303	298	306/307	
328		327	
303	298	306/307	



Plugs

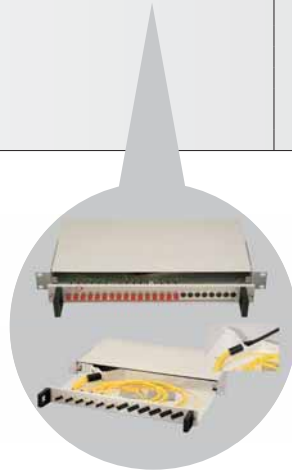

Splice Boxes

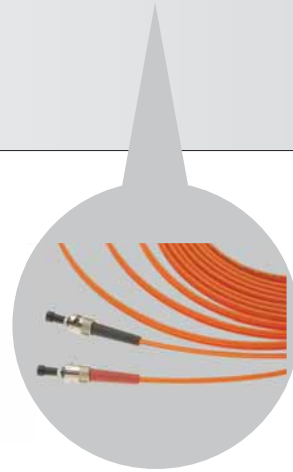

Jumper Cables

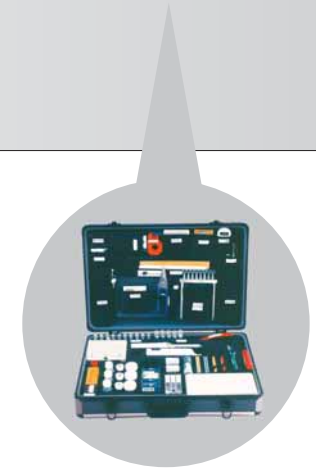

Processing Technic



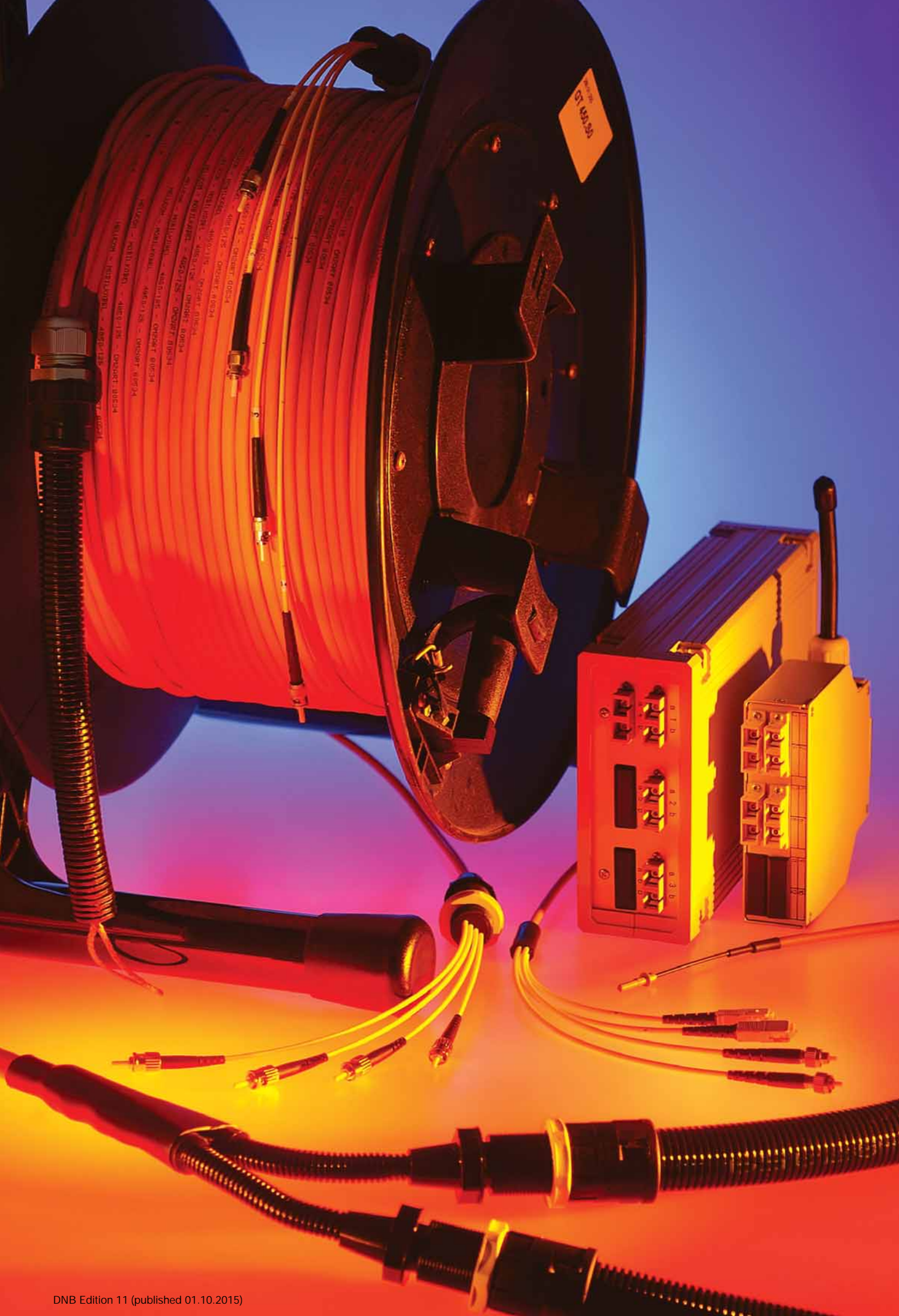

Installation area	Areal	Application	Category	Frequency range MHz	Application area	UL	CSA	Flame retardance		
Office	fixed	5	100	Floor-/Building wiring of security areas	-	-	IEC 60332-3			
		5 <sub>e</sub>	155	Floor-/Building wiring	-	-	-			
		5 <sub>e</sub>	155	Floor-/Building wiring	-	-	-			
		5 <sub>e</sub>	155	Floor-/Building wiring	x	x	IEC 60332-1			
		5 <sub>e</sub>	200	Floor-/Building wiring	-	-	IEC 60332-3			
		5 <sub>e</sub>	200	Floor-/Building wiring	-	-	IEC 60332-3			
		6	300	Floor-/Building wiring	x	x	IEC 60332-1			
		6	300	Floor-/Building wiring	-	-	IEC 60332-1			
		6	450	Floor-/Building wiring	-	-	IEC 60332-3			
		6	450	Floor-/Building wiring	-	-	IEC 60332-3			
		6 <sub>A</sub>	500	Floor-/Building wiring	-	-	IEC 60332-3			
		6 <sub>A</sub>	500	Floor-/Building wiring	-	-	IEC 60332-3			
		6	600	Floor-/Building wiring	x	-	IEC 60332-1			
		7 <sub>e</sub>	1000	Floor-/Building wiring	-	-	IEC 60332-3			
		7 <sub>e</sub>	1000	Floor-/Building wiring	-	-	IEC 60332-3			
		7 <sub>A</sub>	1200	Floor-/Building wiring	-	-	IEC 60332-3			
		7 <sub>A</sub>	1200	Floor-/Building wiring	-	-	IEC 60332-3			
		8(draft)	1200	Floor-/Building wiring	-	-	IEC 60332-3			
		8(draft)	1200	Floor-/Building wiring	-	-	IEC 60332-3			
		8(draft)	1500	Floor-/Building wiring, multimedia areas	-	-	IEC 60332-3			
		8(draft)	1500	Floor-/Building wiring, multimedia areas	-	-	IEC 60332-3			
		flexible	5	100	Workarea/Floor-wiring (Patchkabel)	-	-	-		
			5	100	Workarea/Floor-wiring (Patchkabel)	-	-	IEC 60332-1		
			5 <sub>e</sub>	200	Workarea/Floor-wiring (Patchkabel)	-	-	IEC 60332-1		
	5 <sub>e</sub>		200	Workarea/Floor-wiring (Patchkabel)	x	x	IEC 60332-1			
	6		300	Workarea/Floor-wiring (Patchkabel)	-	-	IEC 60332-1			
	6		300	Workarea/Floor-wiring (Patchkabel)	x	x	IEC 60332-1			
	6 <sub>A</sub>		500	Workarea/Floor-wiring (Patchkabel)	-	-	IEC 60332-1			
	7	600	Workarea/Floor-wiring (Patchkabel)	-	-	IEC 60332-1				
	Industry	fixed	5	100	Industry cabling Motion Control	x	x	IEC 60332-1		
			5 <sub>e</sub>	100	Industry cabling (Control- Automation- and Regulation Level)	-	-	IEC 60332-1		
			5 <sub>e</sub>	100	Industry cabling (Control- Automation- and Regulation Level)	-	-	IEC 60332-1		
			5 <sub>e</sub>	100	Industry cabling (Control- Automation- and Regulation Level)	x	x	IEC 60332-3		
			5 <sub>e</sub>	100	Industry cabling (Control- Automation- and Regulation Level)	x	x	IEC 60332-3		
			5 <sub>e</sub>	100	Industry cabling (Control- Automation- and Regulation Level)	-	-	IEC 60332-1		
			5 <sub>e</sub>	100	Industry cabling, radiated areas (Control- Automation- and Regulation Level)	-	-	-		
			7 <sub>A</sub>	1200	Industry cabling, (Control- Automation- and Regulation Level)	-	-	IEC 60332-1		
			6	250	Industry cabling (Control- Automation- and Regulation Level)	x	x	IEC 60332-3		
			6	250	Industry cabling (Control- Automation- and Regulation Level)	x	x	IEC 60332-1		
			6 <sub>A</sub>	500	Industry cabling, (Control- Automation- and Regulation Level)	x	x	IEC 60332-3		
			7 <sub>e</sub>	1200	Industry cabling, (Control- Automation- and Regulation Level)	-	-	IEC 60332-1		
			7	600	Schiffsverkabelung (Control- Automation- and Regulation Level)	-	-	IEC 60332-3		
			flexible	5	100	Industry cabling, flexible (Control- Automation- and Regulation Level)	x	x	IEC 60332-3	
				5 <sub>e</sub>	100	Industry cabling (Control- Automation- and Regulation Level)	-	-	IEC 60332-1	
				5 <sub>e</sub>	100	Industry cabling (Control- Automation- and Regulation Level)	-	-	IEC 60332-1	
				5 <sub>e</sub>	100	Industry cabling, flexible (Control- Automation- and Regulation Level)	x	x	IEC 60332-1	
				5 <sub>e</sub>	100	Industry cabling, flexible (Control- Automation- and Regulation Level)	x	x	IEC 60332-3	
				5 <sub>e</sub>	100	Industry cabling, flexible (Control- Automation- and Regulation Level)	-	-	IEC 60332-1	
5 <sub>e</sub>				100	Schiffsverkabelung (Control- Automation- and Regulation Level)	x	x	IEC 60332-1		
5 <sub>e</sub>				100	Industry cabling, flexible (Control- Automation- and Regulation Level)	x	x	IEC 60332-1		
5 <sub>e</sub>				100	Industry cabling, flexible (Control- Automation- and Regulation Level)	x	-	IEC 60332-1		
6				250	Industry cabling, flexible (Control- Automation- and Regulation Level)	x	x	IEC 60332-3		
7				600	Industry cabling, flexible (Control- Automation- and Regulation Level)	x	x	IEC 60332-1		
7 <sub>A</sub>		1000		Industry cabling, flexible (Control- Automation- and Regulation Level)	-	-	IEC 60332-1			
high flexible		5		100	Industry cabling, high flexible (Process- and Field Level)	-	-	IEC 60332-1		
		5		100	Industry cabling, high flexible (Process- and Field Level)	-	-	IEC 60332-1		
		5	100	Industry cabling Motion Control	x	x	IEC 60332-1			
		5	100	Industry cabling Motion Control	x	x	IEC 60332-1			
		5 <sub>e</sub>	100	Industry cabling, high flexible (Process- and Field Level)	x	x	IEC 60332-1			
		5 <sub>e</sub>	100	Industry cabling, high flexible (Process- and Field Level)	x	x	IEC 60332-3			
		5 <sub>e</sub>	155	Industry cabling, high flexible (Process- and Field Level)	x	-	IEC 60332-1			
		5 <sub>e</sub>	155	Industry cabling, high flexible (Process- and Field Level)	x	x	IEC 60332-1			
		5 <sub>e</sub>	155	Industry cabling, high flexible (Process- and Field Level)	x	x	IEC 60332-1			
		6	250	Industry cabling, high flexible (Process- and Field Level)	x	x	IEC 60332-1			
		6 <sub>A</sub>	500	Industry cabling, high flexible (Process- and Field Level)	x	x	IEC 60332-3			
		6 <sub>A</sub>	500	Industry cabling, high flexible (Process- and Field Level)	x	x	IEC 60332-1			
		6 <sub>A</sub>	500	Industry cabling, high flexible (Control- Automation- and Regulation Level)	x	x	IEC 60332-1			
		7	600	Industry cabling, high flexible (Process- and Field Level)	x	x	IEC 60332-1			
Outside		Outdoor	fixed	5 <sub>e</sub>	100	Industry cabling, rodent attacked areas (Campus- and Building wiring)	-	-	-	
				5 <sub>e</sub>	200	Campus backbone	-	-	-	
				6	300	Campus backbone	-	-	-	
				7 <sub>e</sub>	1000	Campus backbone	-	-	IEC 60332-1	
				7 <sub>e</sub>	1000	Campus backbone with rodent attacked	-	-	IEC 60332-1 (Inside cables)	
				7 <sub>e</sub>	1000	Campus backbone	x	x	IEC 60332-1	

halogen-free	Oil resistant	UV resistant	Construction	Core number	Core dimension	Description*	Part no.	Page
x	-	-	F/UTP	4 x 2 x	AWG23/1	HELUKAT 100 F/UTP FE60	804045	100
-	-	-	U/UTP	4 x 2 x	AWG24/1	HELUKAT 155 U/UTP	80053	90
-	-	-	F/UTP	4 x 2 x	AWG24/1	HELUKAT 155 F/UTP	80043	98
-	-	-	U/UTP	4 x 2 x	AWG24/1	HELUKAT 155 U/UTP UL	802171	91
x	-	-	SF/UTP	4 x 2 x	AWG24/1	HELUKAT 200 SF/UTP	81609, 81610	103
x	-	-	SF/UTP	2 x 4 x 2 x	AWG24/1	HELUKAT 200 SF/UTP duplex	81123	104
-	-	-	U/UTP	4 x 2 x	AWG24/1	HELUKAT 300 U/UTP UL	802172	92
x	-	-	U/UTP	4 x 2 x	AWG24/1	HELUKAT 300 U/UTP	804766	93
x	-	-	F/FTP	4 x 2 x	AWG24/1	HELUKAT 450 F/FTP	82501	107
x	-	-	F/FTP	2 x 4 x 2 x	AWG24/1	HELUKAT 450 F/FTP duplex	82502	108
x	-	-	F/FTP	4 x 2 x	AWG23/1	HELUKAT 500 F/FTP	803378	109
x	-	-	F/FTP	2 x 4 x 2 x	AWG23/1	HELUKAT 500 F/FTP duplex	803379	110
x	-	-	U/UTP	4 x 2 x	AWG23/1	HELUKAT 600 U/UTP	805179	94
x	-	-	S/FTP	4 x 2 x	AWG23/1	HELUKAT 600 S/FTP	80810	112
x	-	-	S/FTP	2 x 4 x 2 x	AWG23/1	HELUKAT 600 S/FTP duplex	81446	113
x	-	-	S/FTP	4 x 2 x	AWG23/1	HELUKAT 1200 S/FTP	803380	118
x	-	-	S/FTP	2 x 4 x 2 x	AWG23/1	HELUKAT 1200 S/FTP duplex	803381	119
x	-	-	S/FTP	4 x 2 x	AWG22/1	HELUKAT 1200 S/FTP	81699	120
x	-	-	S/FTP	2 x 4 x 2 x	AWG22/1	HELUKAT 1200 S/FTP duplex	800647	121
x	-	-	S/FTP	4 x 2 x	AWG22/1	HELUKAT 1500 S/FTP	802169	122
x	-	-	S/FTP	2 x 4 x 2 x	AWG22/1	HELUKAT 1500 S/FTP duplex	802170	123
-	-	-	U/UTP	4 x 2 x	AWG26/7	HELUKAT 100 U/UTP flex	80055	95
x	-	-	F/UTP	4 x 2 x	AWG26/7	HELUKAT 100 F/UTP flex	81278	99
x	-	-	SF/UTP	4 x 2 x	AWG26/7	HELUKAT 200 SF/UTP flex	81254	105
-	-	-	F/UTP	4 x 2 x	AWG26/7	HELUKAT 200 F/UTP flex UL	802173	101
x	-	-	U/UTP	4 x 2 x	AWG24/7	HELUKAT 300 U/UTP flex	804996	96
-	-	-	U/FTP	4 x 2 x	AWG26/7	HELUKAT 300 U/FTP flex UL	802174	106
x	-	-	F/FTP	4 x 2 x	AWG26/1	HELUKAT 500 F/FTP flex	804043	111
x	-	-	S/FTP	4 x 2 x	AWG26/7	HELUKAT 600 S/FTP flex	80294	114
-	x	-	S/FTP	2 x 2 x	AWG22/7	HELUKABEL HMCB 200, fixed	802471	181
x	-	-	SF/UTP	2 x 2 x	AWG24/1	HELUKABEL 100IND Industrial Ethernet FRNC	805699	142
x	x	-	SF/UTP	2 x 2 x	AWG24/1	HELUKABEL 100IND Industrial Ethernet PUR Robust	805700	142
-	x	x	SF/UTP	2 x 2 x	AWG22/1	HELUKAT 100IND PROFINet A, PVC fixed	800653	151
x	-	-	SF/UTP	2 x 2 x	AWG22/1	HELUKAT 100IND PROFINet A, FRNC CMG	805653	152
x	x	x	SF/UTP	2 x 2 x	AWG22/1	HELUKAT 100IND PROFINet A, robust	801194	151
-	x	x	SF/UTP	2 x 2 x	AWG22/1	HELUKAT 100IND PROFINet A, radiation resistant	801195	153
x	x	x	S/FTP	4 x 2 x	AWG23/1	HELUKAT 1000IND S/FTP, Robust	805680	130
-	x	-	SF/UTP	4 x 2 x	AWG24/1	HELUKAT 250IND SF/UTP, PVC CMG	805655	138
-	x	-	SF/UTP	4 x 2 x	AWG24/1	HELUKAT 250IND SF/UTP, PVC AWM	805681	139
-	x	x	S/FTP	4 x 2 x	AWG22/1	HELUKAT 500IND S/FTP, 10GIG	803693	135
x	x	-	S/FTP	4 x 2 x	AWG23/1	HELUKAT 600IND S/FTP, Robust	801197	129
x	x	-	S/FTP	4 x 2 x	AWG24/7	HELUKAT 600IND S/FTP, Shipline	803382	133
x	x	x	SF/UTP	2 x 2 x	AWG22/7	HELUKAT 100 SF/UTP, WK Industrial 105°C	802293	145
x	-	-	SF/UTP	2 x 2 x	AWG26/7	HELUKABEL 100IND Industrial Ethernet FRNC flexible	805701	143
x	x	-	SF/UTP	2 x 2 x	AWG26/7	HELUKABEL 100IND Industrial Ethernet PUR Robustflex	805702	143
-	x	x	SF/UTP	2 x 2 x	AWG22/7	HELUKAT 100IND PROFINet B, PVC flexible	800654	154
x	-	-	SF/UTP	2 x 2 x	AWG22/7	HELUKAT 100IND PROFINet B, FRNC CMG flexible	805654	155
x	-	-	SF/UTP	2 x 2 x	AWG22/7	HELUKAT 100IND PROFINet B, FRNC flexible	805659	155
x	x	x	SF/UTP	2 x 2 x	AWG22/7	HELUKAT 100IND PROFINet B, Shipline	802185	157
-	x	x	SF/UTP	2 x 2 x	AWG22/7	HELUKAT 100IND PROFINet B, Festoon	803295	157
x	x	x	SF/UTP	2 x 2 x + 4 x	AWG22/7 + 1,5mm <sup>2</sup>	HELUKAT 100IND PROFINet B, hybrid	801651	156
x	x	-	SF/UTP	4 x 2 x	AWG26/7	HELUKAT 200IND SF/UTP, Robustflex	800068	144
-	x	-	SF/UTP	4 x 2 x	AWG24/7	HELUKAT 250S SF/UTP, PVC CMG Drag chain	805658	140
x	x	x	S/FTP	4 x 2 x	AWG26/7	HELUKAT 600IND S/FTP, Robustflex	802184	134
x	x	x	S/FTP	4 x 2 x	AWG26/7	HELUKAT 1200IND S/FTP, Robustflex	805684	131
x	x	-	SF/UTP	4 x 1 x	AWG24/19	HELUKAT 200S SF/UTP, Drag chain	800088	148
x	x	-	SF/UTP	4 x 2 x	AWG24/19	HELUKAT 200S SF/UTP, Drag chain	81155	149
x	x	-	SF/UTP	4 x 2 x	AWG26/19	HELUKAT 100T SF/UTP, Tordierflex	800067	150
-	x	-	SF/UTP	2 x 2 x + 1 x 2 x	AWG24/7 + AWG22/19	HELUKABEL HMCB 500S, Drag chain	803672	183
x	x	-	SF/UTP	2 x 2 x + 1 x 2 x	2x2x0,20 + 1x2x0,38	HELUKABEL HMCB 800W, Drag chain	804767	184
x	x	x	SF/UTP	2 x 2 x	AWG22/7	HELUKAT 100IND PROFINet C, high flexible	800655	158
-	x	x	SF/UTP	2 x 2 x	AWG22/7	HELUKAT 100IND PROFINet C, CMG high flexible	802914	158
x	x	x	SF/UTP	2 x 2	AWG22/19	HELUKAT 100IND PROFINet C, Torsion	802186	159
x	x	x	SF/UTP	4 x 1 x	AWG26/19	HELUKAT 100S SF/UTP, Drag chain ECO	82838	146
x	x	x	SF/UTP	4 x 2 x	AWG26/19	HELUKAT 100S SF/UTP, Drag chain ECO	82839	147
-	x	x	SF/UTP	4 x 2 x	AWG26/19	HELUKAT 250S SF/UTP, Drag chain	803387	141
-	x	-	SF/FTP	4 x 2 x	AWG24/7	HELUKAT 500S SF/FTP, PVC CMG Drag chain	805704	136
x	x	x	SF/FTP	4 x 2 x	AWG24/7	HELUKAT 500S SF/FTP, PUR Drag chain	805703	136
x	x	x	SF/FTP	4 x 2 x	AWG26/7	HELUKAT 500S SF/FTP, Drag chain	805548	137
x	x	x	SF/FTP	4 x 2 x	AWG24/7	HELUKAT 600S SF/FTP, Drag chain	805614	132
-	x	x	SF/UTP armiert	2 x 2 x	AWG22/1	HELUKAT 100IND PROFINet A, armoured	801650	153
x	-	x	F/UTP	4 x 2 x	AWG24/1	HELUKAT 200A F/UTP PE	805572	102
x	-	x	U/UTP	4 x 2 x	AWG24/1	HELUKAT 300A U/UTP PE	805683	97
-	-	x	S/FTP PVC/PVC	4 x 2 x	AWG23/1	HELUKAT 600A S/FTP PVC/PVC	801147	115
x	-	x	S/FTP FRNC/PE armiert	4 x 2 x	AWG23/1	HELUKAT 600AE S/FTP FRNC/PE	802168	117
-	-	x	S/FTP PVC	4 x 2 x	AWG 23/1	HELUKAT 600E S/FTP PVC	802167	116

Accessories				
Plug	Patch panels	Jumper Cable	Processing Technic	
	Page	Page	Page	
-	-	-	from 346	
-	232, 237	253		
-	232, 238	251, 252		
-	232, 237	253		
B6	232, 238	251, 252		
B6	232, 238	251, 252		
-	232, 237	249, 250, 246		
-	232, 237	249, 250, 246		
B6*5, B7*5	232, 236	247, 248		
B6*5, B7*5	232, 236	247, 248		
B3	232, 235	245		
B3	232, 235	245		
-	232, 237	249, 250, 246		
B3, B4	232, 235, 236	249		
B3, B4		245		
B3, B4*2		245		
B3, B4*2		245		
B3, B4*2		245		
B3, B4*2		245		
B3, B4*2		245		
-		245		
-		245		
B1				
B1, B6, B7				
B1, B2, B6, B7, B13, B14				
B1				
-				
B1, B2, B6, B7, B13, B14				
B2				
B2*2				
-				
B5, B6, B7, B8, B9, B10, B11, B12, B13, B14, B19	from 260	265 to 277		
B5, B6, B7, B8, B9, B10, B11, B12, B13, B14, B19				
B5, B6, B7, B8, B9, B10, B11, B12, B13, B14, B19				
B5, B6, B7, B8, B9, B10, B11, B12, B13, B14, B19				
B13, B14, B19				
B13, B14, B19				
B13, B14, B19				
B13, B14, B19				
B6, B7				
a.A.				
B5, B6, B7, B8, B9, B10, B11, B12, B13, B14, B19				
B5, B6, B7, B8, B9, B10, B11, B12, B13, B14, B19				
B5, B6, B7, B8, B9, B10, B11, B12, B13, B14, B19				
B5, B6, B7, B8, B9, B10, B11, B12, B13, B14, B19				
B5, B6, B7, B8, B9, B10, B11, B12, B13, B14, B19				
B1, B2, B6, B7, B13, B14, B19				
B13, B14, B19				
B2, B6, B7, B13, B14, B19				
B13, B14, B19				
B5, B6, B7, B8				
-				
B6, B7, B8				
-				
-				
B5, B6, B7, B8, B9, B10, B11, B12, B13, B14, B19				
B5, B6, B7, B8, B9, B10, B11, B12, B13, B14, B19				
B5, B6, B7, B8, B9, B10, B11, B12, B13, B14, B19				
B1, B6, B7				
B1, B2				
B6, B7*5				
B13, B14, B19				
B13, B14, B19				
B13, B14, B19				
B13, B14, B19				
B9, B10, B11, B12	from 280			
B3, B4*	262, 263			
B3, B4*				
B3, B4*				
B3, B4*				

- \* Preparation of the jacket before connection necessary
- \*2 Reduced frequency to Cat.6
- \*3 Plugsystem- and ref. to the applications
- \*4 Reduced frequency to Cat. 6 bzw. Cat. 5e
- \*5 Reduced frequency to Cat. 5e

# Plug Matrix Copper Data Systems



		Part no. Page	Description
B1		801686 Page 254	RJ45 Plug TM11 Cat.5
B2		801772 Page 254	RJ45 Plug TM21 Cat.6
B3		802377 Page 232	RJ45 Jack Cat.6 <sub>A</sub>
B4		802916 Page 232	RJ45 Jack Cat.6/ Class E
B5		800986 Page 283	RJ45 Plug 4-pole/ IP 20, Cat.5
B6		802920 Page 283	RJ45 Plug 8-pole/ IP 20, Cat.5
B7		804234 Page 283	RJ45 Plug 90° 8-pole/ IP 20, Cat.5
B8		801318 Page 283	RJ45 Plug Snap-in 8-pole/ IP 67, Cat.5
B9		805401 Page 284	RJ45 Profinet Cat.5 tool free, 4-pole
B10		805402 Page 284	RJ45 Profinet 90° Cat.5 tool free, 4-pole

		Part no. Page	Description
B11		805781 Page 284	RJ45 Profinet IE Cat.5 tool free, 4-pole
B12		805782 Page 284	RJ45 Profinet IE Cat.5 45° tool free, 4-pole
B13		805783 Page 284	RJ45 IE Cat.6, tool free, 8-pole
B14		805784 Page 284	RJ45 IE 45° Cat. 6, tool free, 8-pole
B15		805586 Page 232	RJ45 Jack Cat.7 <sub>A</sub> AMP-Twist
B16		804691 Page 232	RJ45 Jack Cat.6
B17		805044 Page 232	RJ45 Jack Cat.6
B18		804645 Page 232	RJ45 Jack Cat.5e
B19		804544	RH45 IE Kat6A, tool free, 8-pole

## Patch Cables



## Splice Box, DIN rail



## Splice Box



## Outlet



Bus Systems	Areal	Installation area	Application	UL	CSA	Flame retardance	halogen-free	Oil resistant	UV resistant	
Profibus 150 Ohm	Industry	Inside	fixed	-	-	IEC 60332-1	x	x	-	
				-	-	IEC 60332-1	x	x	x	
				-	-	IEC 60332-1, EN50289-4-16	x	-	-	
				x	x	IEC 60332-1	-	-	-	
				-	-	IEC 60332-1	-	-	-	
				x	x	IEC 60332-3	-	-	x	
			x	x	EN 50265-2-1	x	-	x		
			x	x	IEC 60332-1	x	x	x		
			-	-	IEC 60332-1	x	-	-		
			x	x	IEC 60332-3	-/x	-	-		
			x	-	EN 50265-2-1	-	-	-		
			-	-	IEC 60332-1	x	x	-		
		x	-	-	x	x	x			
		x	-	IEC 60332-1	x	x	-			
		x	x	IEC 60332-1	x	x	-			
		x	x	EN 50265-2-1	-	-	x			
x	x	IEC 60332-1	x	x	x					
-	-	-	-	-	x					
-	-	-	-	-	-					
-	-	-	-	-	x					
-	-	-	-	-	-					
Profibus PA 100 Ohm	Industry	Inside	fixed	x	-	EN 50265-2-1	-	-	-	
				x	-	IEC 60332-1	-	-	-	
		Inside/Outside		-	-	EN 50265-2-1	-	-	x	
				-	-	EN 50265-2-1	-	-	x	
CAN Bus 120 Ohm	Industry	Inside	fixed	x	-	IEC 60332-1	-	-	-	
				x	-	IEC 60332-1	-	-	-	
				x	-	IEC 60332-1	-	-	-	
				x	x	IEC 60332-1	-	-	-	
				x	-	IEC 60332-1	-	-	-	
				x	x	IEC 60332-1	-	-	-	
		x	x	IEC 60332-1	-	-	-			
		flexible/fixed	x	x	IEC 60332-1	x	x	x		
			-	-	-	x	x	-		
		high flexible	x	-	IEC 60332-1	x	x	-		
x	-		IEC 60332-1	x	x	-				
Outside	fixed	x	-	IEC 60332-1	x	x	-			
		-	-	-	-	-	x			
Foundation™ Fieldbus 100 Ohm	Industry	Inside/Outside	fixed	x	x	x	-	x	x	
				x	x	x	-	x	x	
			flexible	x	x	x	-	x	x	
				x	x	x	-	x	x	
DeviceNet™ 120 Ohm	Industry	Inside	fixed	x	x	IEC 60332-1	-	x	x	
				x	x	IEC 60332-1	x	-	x	
			x	x	IEC 60332-1	-	-	x		
		high flexible	x	x	VW 1	x	x	x		
Interbus 100 Ohm	Industry	Inside	fixed	x	-	IEC 60332-1	-	-	-	
				x	-	IEC 60332-1	-	-	-	
			high flexible	-	-	IEC 60332-1	x	-	-	
				-	-	IEC 60332-1	x	x	-	
AS Interface	Industry	Inside	flexible	-	-	-	x	x	x	
				-	-	-	x	x	-/x	
				-	-	IEC 60332-1	-	x	-/x	
			x	x	IEC 60332-1	-	x	-/x		
			x	-	IEC 60332-1	x	x	-		
			x	x	IEC 60332-1	x	x	-/x		
CC Link	Industry	Inside	fixed	x	x	IEC 60332-1	-	x	x	
				x	x	IEC 60332-1	-	x	x	
Safety BUS 110 Ohm	Industry	Inside	fixed	-	-	IEC 60332-1	x	x	-	
			high flexible	x	x	IEC 60332-1	x	x	-	
Multibus	Industry	Inside	high flexible	x	x	VW 1/ FT1	x	x	-	
				x	x	VW 1/ FT1	x	x	-	
USB 2.0 90 Ohm	Industry	Inside	high flexible	x	x	IEC 60332-1	-	x	-	
				x	x	IEC 60332-1	-	x	-	
USB 3.0	Industry	Inside	high flexible	x	x	IEC 60332-1	x	x	-	
FireWire™ 800	Industry	Inside	high flexible	x	x	IEC 60332-1	x	x	-	
Coax 50 Ohm	Industry	Inside	high flexible	-	-	IEC 60332-1	x	x	x	
EIB Bus 100 Ohm	Office	Inside	fixed	-	-	IEC 60332-1	-	-	-	
				-	-	IEC 60332-1	x	-	-	
				-	-	IEC 60332-1	x	-	-	
		Outside	fixed	-	-	IEC 60332-1	-	-	-	
MOD-Bus	Office	Inside/Outside	fixed	-	-	IEC 60332-3	-	x	x	
				-	-	IEC 60332-3	-	x	x	
LON Bus 100/85 Ohm	Office	Inside	fixed	-	-	IEC 60332-1	x	-	-	
			flexible	-	-	IEC 60332-1	-	-	-	
			flexible	-	-	IEC 60332-1	x	-	-	
			flexible	-	-	IEC 60332-1	-	-	-	
Hospital-System-Bus	Office	Inside	fixed	-	-	IEC 60332-1	-/x	-	-	
				-	-	IEC 60332-1	-/x	-	-	

Construction	Description	Part no.	Page
konventionell	Profibus L2 1x2x0,64mm PUR petrol	81186	161
konventionell	Profibus High temperature FEP violett	802179	168
konventionell	Profibus L2 High temperature FRNC 200° FE120 black	805706	164
konventionell	Profibus L2 FRNC FE120 red	805695	176
konventionell	Profibus L2 1x2x0,64mm PVC grey / violett	80384 / 81448	160
konventionell	Profibus L2 1x2x0,64mm PVC 105° violett	805705	164
Fast Connect (SK)	Profibus SK 1x2x0,64mm PVC violett	81903	174
Fast Connect (SK)	Profibus SK 1x2x0,64mm FRNC violett	81501	175
Fast Connect (SK)	Profibus SK 1x2x0,64mm PUR violett	81905	175
Fast Connect (SK)	Profibus SHIPLINE FRNC violett	802178	168
Fast Connect (SK)	Profibus SK 7-wire 1x2xAWG23/7 PVC violett / 7FRNC violett	805656 / 805657	-
konventionell	Profibus L2/FIP 7-wire PVC violett	800648	163
konventionell	Profibus L2 Drag chain 1x2x0,64mm (Litze) PUR petrol / violett	81003 / 80267	166
konventionell	Profibus ET20X PUR petrol	82913	167
konventionell	Profibus ECOFAST TPU petrol	800044	167
konventionell	Profibus L2 Torsion PUR violett	800109	170
konventionell	Profibus L2 FixedOON PVC petrol	800649	170
Fast Connect (SK)	Profibus SK Drag chain 1x2x0,64mm (Litze) PUR violett / petrol	801659 / 81906	177
konventionell	Profibus L2 1x2x0,64mm PE black	80792	161
konventionell	Profibus L2 ERD 1x2x0,64mm PVC/PE black	82824	162
konventionell	Profibus L2 ERD armoured 1x2x0,64mm PE/PE black	802177	162
Fast Connect (SK)	Profibus SK 1x2x0,64mm PE black	81904	174
konventionell	Profibus PA EX 1x2x1,0/ 2,55 PVC blue	82835	171
konventionell	Profibus PA Long Distance EX 1x2x1,6/ 3,2 PVC blue	800650	173
konventionell	Profibus PA EX armoured 1x2x1,0/ 2,55 PVC/PVC blau	802180	172
konventionell	Profibus PA not EX 1x2x1,0/ 2,55 PVC black	82836	171
konventionell	Profibus PA not EX armoured 1x2x1,0/ 2,55 PVC/PVC black	802181	172
konventionell	Profibus PA Long Distance not EX 1x2x1,6/ 3,2 PVC black	800715	173
1x2x0,22 / 4x1x0,22	CAN Bus 2x0,22 PVC violett / CAN Bus 4x0,22 PVC violett	81286 / 81287	190
2x2x0,22	CAN Bus 4x0,22 PVC violett	82509	191
1x2x0,34 / 4x1x0,34	CAN Bus 2x0,34 PVC violett / CAN Bus 4x0,34 PVC violett	801572 / 801573	193
2x2x0,34	CAN Bus 4x0,34 PVC violett	803344	194
1x2x0,5 / 4x1x0,5	CAN Bus 2x0,5 PVC violett / CAN Bus 4x0,5 PVC violett	800571 / 800685	195
2x2x0,5	CAN Bus 4x0,5 PVC violett	803722	196
1x2x0,75 / 4x1x0,75	CAN Bus 2x0,75 PVC violett / CAN Bus 4x0,75 PVC violett	803383 / 803384	198
2x2xAWG24/19	CAN Bus 105°C 4xAWG24 PUR violett	801982	192
1x2x0,25 / 4x1x0,25	CAN Bus Drag chain 2x0,25 PUR violett / 4x0,25 PUR violett	81911 / 81912	195
1x2x0,34 / 4x1x0,34	CAN Bus Drag chain 2x0,34 PUR violett / 4x0,34 PUR violett	802182 / 802339	200
1x2x0,5	CAN Bus Drag chain 2x0,5 PUR violett	805685	201
4x1x0,5	CAN Bus Drag chain 4x0,5 PUR violett	805696	201
1x2x0,5, 4x1x0,5	CAN Bus ERD 2x0,5 PVC/PE black / CAN Bus ERD 4x0,5 PVC/PE black	804268 / 804269	197
1x2x1,1/2,85-100 + 1x0,8 gnge	Foundation™ Fieldbus Typ A armoured, PVC yellow	801192	180
1x2x1,1/2,55-100	Foundation™ Fieldbus Basic PVC orange	803354	178
1x2x1,1/2,85-100 + 1x0,8 gnge	Foundation™ Fieldbus Typ A + gnge, PVC yellow	801191	179
1x2x1,1/2,85-10	Foundation™ Fieldbus Typ A, PVC yellow	801193	181
1x2xAWG18 + 1x2xAWG15/ 1x2xAWG24 + 1x2xAWG22	DeviceNet™ Thick PVC grey/ Thin PVC grey	800683 / 800684	214
1x2xAWG18 + 1x2xAWG15/ 1x2xAWG24 + 1x2xAWG22	DeviceNet™ Thick FRNC violett/ Thin FRNC violett	800681 / 800682	215
1x2xAWG18 + 1x2xAWG15/ 1x2xAWG24 + 1x2xAWG22	DeviceNet™ Thick CPE yellow/ Thin CPE yellow	81907 / 81908	216
1x2xAWG18 + 1x2xAWG15/ 1x2xAWG24 + 1x2xAWG22	DeviceNet™ Thick PUR violett/ Thin PUR violett	81909 / 81910	217
3x2x0,22	I-BUS Fernbus Fixed Inside PVC pastell-turquoise	80778	202
3x2x0,22 + 3x1,0	I-BUS Insta-Fernbus Fixed Inside PVC pastell-turquoise	81202	202
3x2x0,22	I-BUS Fernbus Fixed Inside halogen-free pastell-turquoise	81557	203
3x2x025	I-BUS Fernbus Drag chain PUR pastell-turquoise	81203	204
3x2x0,25 + 3x1,0	I-BUS Insta-Fernbus Drag chain PUR pastell-turquoise	82696	204
2x1,5	A-BUS EPDM yellow / black	80824 / 80825	207
2x2,5	A-BUS EPDM Long Distance yellow / black	804408 / 804409	208
2x1,5	A-BUS TPE yellow / black	801846 / 801847	212
2x1,5	A-BUS TPE 105° yellow / black	805693 / 805694	211
2x0,86	AS-Interface Cabinet FRNC yellow	802183	213
2x1,5	A-BUS PUR yellow / black	82434 / 82822	209
2x2,5	A-BUS PUR Long Distance yellow / black	804410 / 804411	210
3x0,5	CC-Link BUS PVC red	800497	218
3x0,75	SafetyBUS FRNC yellow	800651	219
3x0,75	SafetyBUS PUR yellow	800652	219
1x2xAWG22+2x2xAWG22+2x2x0,25+4x1x1,0+1,0	Multibus I 15 core PUR violet	801652	205
1x2x0,34+4x2x0,34+2x1+2x1,5+1,5	Multibus II 15 core PUR violet	804115	206
1x2xAWG28 + 1x2xAWG20	USB Bus S	802469	185
1x2xAWG24 + 1x2xAWG20	USB Bus L	802470	186
1x2xAWG28+2x(1x2xAWG28)+1x2xAWG28	USB Bus 3,0 PUR	805287	187
2x2xAWG26/19 + 2xAWG22/19	FireWire™ 800 PUR	805057	188
HF 50 0,9/2,95	Coax 50 Ohm PUR	804299	189
2x2x0,8	E-BUS 2-pair PVC violett / green	81081 / 81663	224
2x2x0,8	E-BUS 2-pair FRNC violett	80826	225
2x2x0,8	E-BUS 2-pair FRNC green	804042	-
4x2x0,8	E-BUS 4-pair PVC violett	81077	225
2x2x0,8	E-BUS ERD PE black	802800	226
1x2x0,75	MOD-Bus PVC black	805698	223
1x2x0,75 + SW	MOD-Bus PVC armoured black	805697	223
1x2xAWG 22	LON BUS H122 FRNC	802187	220
1x2xAWG 18	LON BUS Y118 PVC	805660	221
1x2xAWG 18	LON BUS H118 FRNC	805662	221
1x2xAWG 16	LON BUS Y116 PVC	802188	220
1x2xAWG 16	LON BUS H116 FRNC	805661	222
2x1,5+2x2x0,6	KH-BUS PVC / FRNC	81085 / 81447	227

Subject to technical alternations.

Accessories			
Plugs	Jumper cable	Processing Technic	
Number	Page	Page	
C1-C4, C9, C18, C19, C22	281,282	356/358	
C1-C4, C9, C18, C19, C22			
C1-C4, C9, C18, C19, C22			
C1-C4, C9, C18, C19, C22			
C1-C4, C9, C18, C19, C22			
C1-C4, C9, C18, C19, C22			
C1-C4, C5, C6, C9, C10, C11, C14, C15, C18, C19, C20, C22			
C1-C4, C5, C6, C9, C10, C11, C14, C15, C18, C19, C20, C22			
C1-C4, C5, C6, C9, C10, C11, C14, C15, C18, C19, C20, C22			
C1-C4, C9, C18, C19, C22			
C1-C4, C5, C6, C9, C10, C11, C14, C15, C18, C19, C20, C22			
C1-C4, C9, C18, C19, C22			
C1-C4, C9, C18, C19, C22			
C1-C4, C9, C18, C19, C22			
C1-C4, C7, C8, C9, C10, C11, C14, C15, C18, C19, C20, C22			
C1-C4, C9, C18, C19, C22			
C1-C4, C9, C18, C19, C22*			
C1-C4, C9, C18, C19, C22*			
C1-C4, C5, C6, C9, C10, C11, C14, C15, C18, C19, C20, C22			
-			
-	-	-	see catalogue „Accessories“
-	-	-	see catalogue „Accessories“
-	-	-	see catalogue „Accessories“
-	-	-	see catalogue „Accessories“
-	-	-	see catalogue „Accessories“
C23 up to C25	-	-	see catalogue „Accessories“
C23 up to C25	-	-	see catalogue „Accessories“
C23 up to C25	-	-	see catalogue „Accessories“
C23 up to C25	-	-	see catalogue „Accessories“
C23 up to C25	-	-	see catalogue „Accessories“
C23 up to C25	-	-	see catalogue „Accessories“
C23 up to C25	-	-	see catalogue „Accessories“
C23 up to C25	-	-	see catalogue „Accessories“
C23 up to C25*	-	-	see catalogue „Accessories“
-	-	-	see catalogue „Accessories“
-	-	-	see catalogue „Accessories“
-	-	-	see catalogue „Accessories“
-	-	-	see catalogue „Accessories“
on request	on request	-	see catalogue „Accessories“
on request	on request	-	see catalogue „Accessories“
on request	on request	-	see catalogue „Accessories“
on request	on request	-	see catalogue „Accessories“
-	-	-	see catalogue „Accessories“
-	-	-	see catalogue „Accessories“
-	-	-	see catalogue „Accessories“
-	-	-	see catalogue „Accessories“
-	-	-	see catalogue „Accessories“
-	-	-	see catalogue „Accessories“
-	-	-	see catalogue „Accessories“
-	-	-	see catalogue „Accessories“
-	-	-	see catalogue „Accessories“
-	-	-	see catalogue „Accessories“
-	-	-	see catalogue „Accessories“
on request	-	-	see catalogue „Accessories“
on request	-	-	see catalogue „Accessories“
on request	278	-	see catalogue „Accessories“
on request	-	-	see catalogue „Accessories“
-	-	-	see catalogue „Accessories“
-	-	-	see catalogue „Accessories“
-	-	-	see catalogue „Accessories“
-	-	-	see catalogue „Accessories“
-	-	-	see catalogue „Accessories“
-	-	-	see catalogue „Accessories“
-	-	-	see catalogue „Accessories“

\* Preparation of the jacket before connection necessary.



# Plug Matrix Bus Systems

	Part no.	Description
C1	802401	Profibus-90°-S
C2	802402	Profibus-90°-PG-S
C3	802403	Profibus-35°-S
C4	802404	Profibus-35°-PG-S
C5	803356	Profibus-45°-SK, solid
C6	803357	Profibus-45°-PG-SK, solid
C7	803576	Profibus-45°-SK, flex
C8	803577	Profibus-45°-PG-SK, flex
C9	802405	Profibus-axial-S
C10	802406	Profibus-90°-SK, solid + flex
C11	802407	Profibus-90°-PG-SK, solid + flex
C14	803194	Profibus-90°-PG-SK Diagnose, solid
C15	803195	Profibus-90°-SK Diagnose, solid
C18	803844	Profibus-90°-PG-S Diagnose
C19	803845	Profibus-90°-S Diagnose
C20	803208	Profibus-axial-SK, solid
C22	803511	Profibus-90°-PG-S Repeater
C23	803234	CAN-axial-S
C24	802967	CAN-90°-S
C25	803272	CAN-90°-GA-S



802401



802402



802403



802404



802405



802407



803194



803195



803844



803845

# ■ ALWAYS CLOSE TO YOU - 41 LOCATIONS IN 24 COUNTRIES

## HELUKABEL® GmbH - Germany

### Headquarters

Dieselstrasse 8-12  
71282 Hemmingen / Stuttgart  
Telephone: +49 7150 9209-0  
Fax +49 7150 81786  
info@helukabel.de

### Sales office & warehouse – Berlin

Zum Mühlenfließ 1  
15366 Neuenhagen / Berlin  
Telephone +49 3342 2397-0  
Fax +49 3342 80033  
info@helukabel.de

### Sales office & warehouse – Pleiße

Eichelbergstrasse 7  
09212 Limbach-Oberfrohna  
Telephone +49 3722 6086-0  
Fax +49 3722 6086-420  
info@helukabel.de

### Sales office – North

Bahnhofstrasse 9  
25524 Itzehoe  
Telephone +49 4821 40394-0  
Fax +49 4821 40394-29  
info@helukabel.de

### Sales office – Rhein-Ruhr

Centroallee 261  
46047 Oberhausen  
Telephone +49 208 882320-0  
Fax +49 208 882320-10  
info@helukabel.de

### Development & production

Neuseser Weg 11  
91575 Windsbach  
Telephone +49 9871 6793-0  
Fax +49 9871 1055  
info@helukabel.de

## Robotec Systems GmbH - Germany

### Head office

Carl-Friedrich-Gauß-Strasse 7  
47475 Kamp-Lintfort  
Telephone: +49 (0)2842 92148-0  
Fax: +49 (0)2842 92148-10  
www.robotec-systems.de  
info@robotec-systems.de

### Branch office – South

Willi-Bleicher-Strasse 4-6  
71282 Hemmingen  
Telephone: +49 (0)7150 9209-308  
Fax: +49 (0)7150 9209-164  
www.robotec-systems.de  
info-sued@robotec-systems.de

## Kabelmat Wickeltechnik GmbH - Germany

Steinbuckelweg 25  
72293 Glatten  
Tel. +49 7443 9670-0  
Fax +49 7443 9670-39  
kabelmat@kabelmat.com

## HELUKABEL® international locations



### HELUKABEL® Austria

Tel: +43 7224 90555 0  
Email: office@helukabel.at



### HELUKABEL® Malaysia

Tel.: +603 7885 8724  
Email: sales@helukabel.com.my



### HELUKABEL® Switzerland

Tel.: +41 56 4181515  
Email: contact@helukabel.ch



### HELUKABEL® Belgium

Tel.: +32 24 81 00 20  
Email: info@helukabel.be



### HELUKABEL® Middle East

Tel.: +971 48 87 95 94  
Email: info@helukabel.ae



### HELUKABEL® Thailand

Tel.: +66 2927 3570 3  
Email: info@helukabel.co.th



### HELUKABEL® Canada

Tel.: +1 289 444 5040  
Email: sales@helukabel.ca



### HELUKABEL® Netherlands

Tel.: +31 495 499 049  
Email: info@helukabel.nl



### HELUKABEL® Turkey

Tel.: +90 212 502 41 95  
Email: info@helukabel.com.tr



### HELUKABEL® China

Tel.: +86 21 58693999  
Email: info@helukabel.com.cn



### HELUKABEL® Poland

Tel.: +48 46 85 80 10 0  
Email: biuro@helukabel.pl



### HELUKABEL® UK

Tel.: +44 151 345 0808  
Email: info@helukabel.co.uk



### HELUKABEL® Czech Republic

Tel.: +42 0312 672 620  
Email: prodej@helukabel.cz



### HELUKABEL® Russia

Tel.: +7 812 449 10 60  
Email: info@helukabel.ru



### HELUKABEL® USA

Tel.: +1 847 930 5118  
Email: sales@helukabel.com



### HELUKABEL® France

Tel.: +33 389 627562  
Email: info@helukabel.fr



### HELUKABEL® Singapore

Tel.: +65 65 54 6170  
Email: sales@helukabel.com.sg



### HELUKABEL® India

Tel.: +91 22 25 18 58 41  
Email: info@helukabel.in



### HELUKABEL® South Africa

Tel.: +27 11 462 8752  
Email: info@helukabel.co.za



### HELUKABEL® Indonesia

Tel.: +62 213 848872  
Email: sales@helukabel.co.id



### HELUKABEL® South Korea

Tel.: +82 51 9728646  
Email: info@helukabel.co.kr



### HELUKABEL® Italy

Tel.: +39 039 6081503  
Email: info@helukabel.it



### HELUKABEL® Sweden

Tel.: +46 8 55 77 4280  
Email: info@helukabel.se

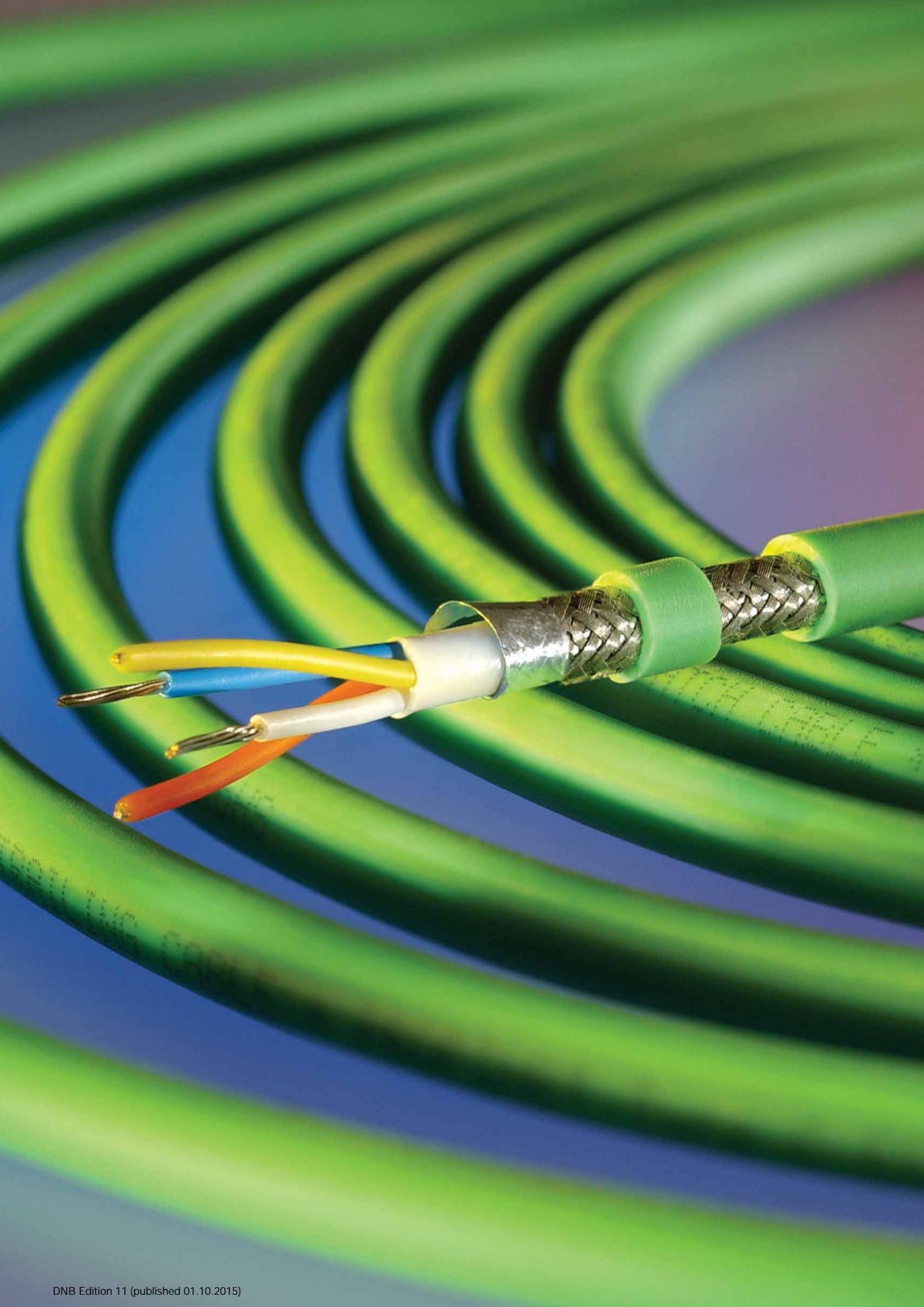

# ■ CHAPTER OVERVIEW



## **Fibre optic cables**

S. 32 - 87

---



## **Network system cabinets**

S. 330 - 343

---

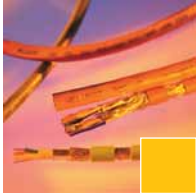

## **Copper data cables**

S. 88 - 125

---



## **Measurement & Processing Technics**

S. 344 - 359

---



## **Bus-Cables**

S. 126 - 227

---



## **Active Components**

S. 360 - 363

---



## **Copper data connection technics - Office**

S. 228 - 255

## **Copper data connection technics - Industry**

S. 256 - 287

---



## **Services**

S. 364 - 367

---



## **Fibre optic connection technics - Office**

S. 288 - 317

## **Fibre optic connection technics - Industry**

S. 318 - 329

---



## **Technical Information**

S. 368 - 448

---

# OVERVIEW OF THE DATA, NETWORK & BUS TECHNOLOGY

## Fibre Optic Cables

HELUCOM®

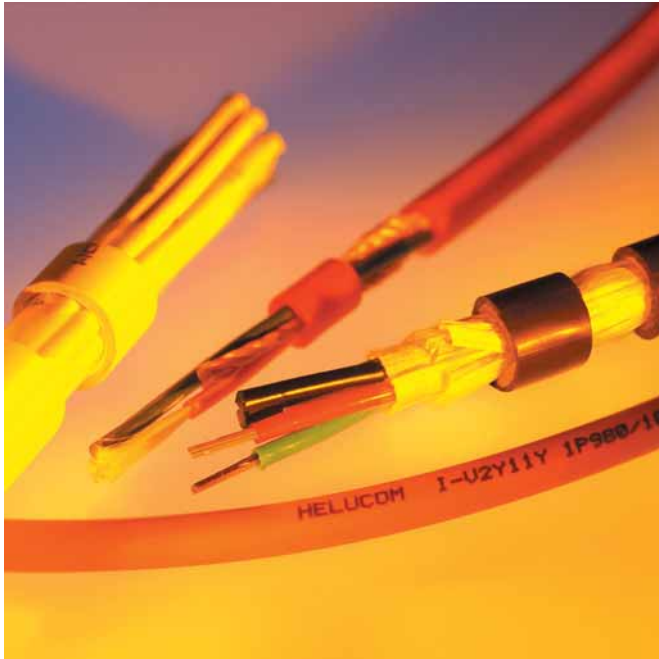

The future reliability of any installation depends on the correct choice of cable used in the network technique. It is only by careful selection of the components that compliance with the continually increasing requirements placed upon the quality of the network is possible. Infrastructures based on copper are continually nearing their physical limits because of the rapidly growing demands from multimedia developments, and hence an alternative to copper must be provided for installations in the future.

The benefits of optical fibre technology are obvious: High transmission rates, low attenuation, no electromagnetic problems, small dimensions and low weight. Modern designs for optical fibre cables of the HELUCOM® series exhibit the same robustness as a copper cable. The cable constructions are selected for optimum protection of the optical fibres in each application.

Within the HELUCOM® series, optical fibre cables are available with the common fibre types of 50/125 µm, 62,5/125 µm, 9/125 µm, 200/230 µm and 980/1000 µm. The HELUCOM® optical fibre cables are manufactured in accordance with the standards and regulations of DIN VDE 0888

## Copper Data Cables

HELUKAT®

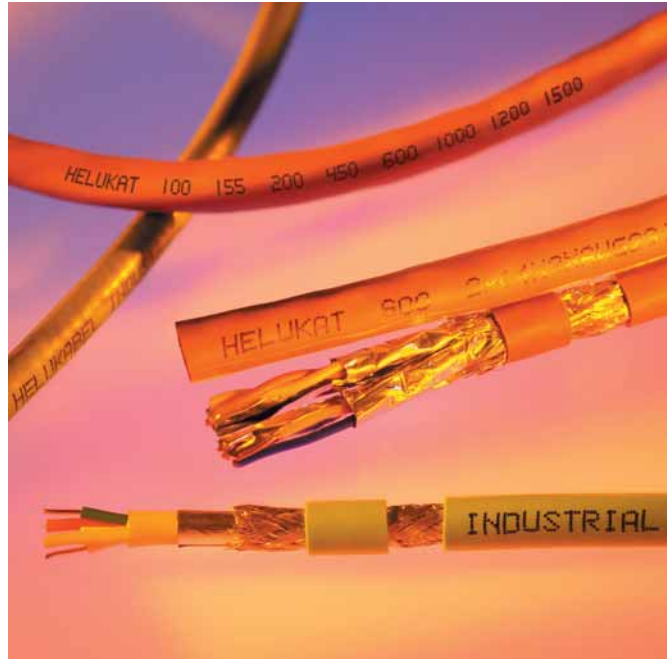

All HELUKAT® data cables and wires comply with the latest standardisation recommendations and are designed for use in high-speed networks with transmission rates of 100 Mbit/s and higher (e.g. CCDI, TPDDI, ATM, SDH/SONET). All HELUKAT® types of cables and wires meet the requirements of category 5 according to EIA/TIA TSB-36 ISO/IEC DIS 11801, CENELEC pr EN 50173, as well as category 6/7 according to DIN 44312-5/ EN 50288. Cables for Ethernet applications, as well as coax/twinal cables for IBMs IVS system complete the product range from HELUKABEL®.

The excellent transmission characteristics of HELUKAT® data cables and wires constitute enormous challenges for production equipment and the measurement laboratories. HELUKAT® data cables and wires are manufactured using the latest machinery technologies. These have been designed for producing cables and wires of the categories 5/6/7/8 in accordance with the latest standardisation recommendations. A special laboratory for high-frequency testing such high transmission rates has been installed complete with network analyser and computer-controlled equipment for HF cables.

## Bus-Cables

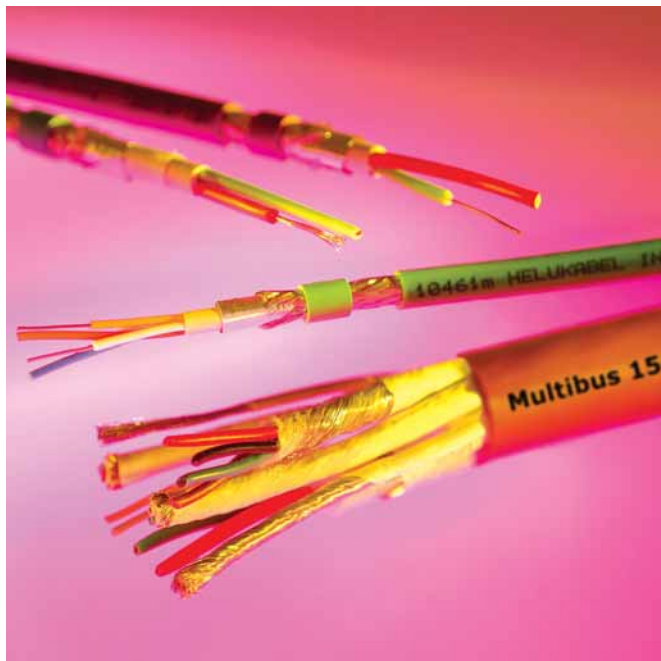

Bus technology is being used in an increasing number of industrial applications. This technology can be applied in every branch in industry where process-control techniques are used. The enormous pressures of competitiveness and costs in all areas of process control emphasise the need for even more rationalisation and greater efficiency. The traditional method of parallel wiring for the equipment and machines does not have the flexibility and thus constitutes a major factor in costs and time. The potential for saving costs from internetworking the machinery by bus systems is very high. So as to keep the amount of cabling low, the information from the master controller is sent over a bus network and is potentially available to all components in the system. Only those components specifically addressed by the information can respond and process these signals. All types of cables and wires used in all common bus systems are available from HELUKABEL®.

## Copper connection equipment

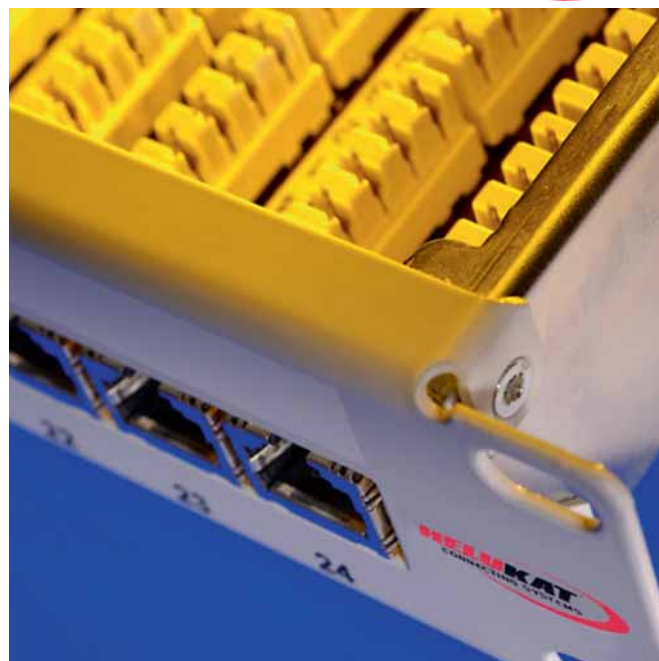

In addition to active components and cables, passive components such as 19" patch panel, patch cable and wiring boxes are necessary for installation and start-up of a data network. The wiring boxes are an important part of both the tertiary wiring and the structured wiring as a whole. These systems, which are also referred to as „IT connection units“, can be installed in floors, walls or a channel system. No additional components are used in the wiring boxes. Also used in conjunction with the wiring boxes are sockets that fit the plug of the patch/connection cable. For operation of the data networks, HELUKABEL® provides complete CONNECTING SYSTEMS, which make it possible to ensure the full reliability and state-of-the-art functioning of the structured building wiring.

### Industrial copper connection components

The Ethernet technology has established itself at the automation and production levels as so-called INDUSTRIAL ETHERNET because it makes continuous communication at all levels of a business network possible. By using standardised interfaces for all communication equipment, the complexity of processes is reduced and the productivity is increased. With new industry-compatible network components based on IP20, IP 65 or IP67, or suitable for DIN rail mounting and standards such as ISO/IEC 24702, the prerequisites for a completely networked future have been created.

The HELUKAT CONNECTING SYSTEMS INDUSTRY series from HELUKABEL® provides passive copper connection components such as patch panels, sockets and patch cables for harsh industrial environments.

# OVERVIEW OF THE DATA, NETWORK & BUS TECHNOLOGY

## Fibre optic connection



In addition to the fibre optic cable, the connection equipment plays an essential role in the construction of glass fibre networks. Optical transmission lines are only complete after installing pigtailed, jumper cables, plugs, couplings, splice boxes and wiring boxes. Regardless of the application, HELUKABEL® has the cable solution that's right for you. This also includes the use of pre-assembled fibre optic cables. In only a short time, we can supply you with pre-assembled kits containing all the most frequently used plugs and cable types. As a result, it is possible to eliminate the high costs involved in obtaining the required tools. In addition, this "plug-and-play" solution helps you to reduce the time necessary for installation. These features are what make HELUCOM CONNECTING SYSTEMS® the ideal choice when it comes to providing our customers economical, high-quality solutions.

### Industrial Fibre optics connection components

Ethernet was initially used exclusively in the office environment. The Ethernet technology has now also established itself at the automation and production levels as so-called INDUSTRIAL ETHERNET because it makes continuous communication at all levels of a business network possible.

By using standardised interfaces for all communication equipment, the complexity of processes is reduced and the productivity is increased. With new industry-compatible network components based on IP20, IP 65 or IP67, or suitable for DIN rail mounting and standards such as ISO/IEC 24702, the prerequisites for a completely networked future have been created.

## Network system cabinets



Universal network system cabinets are the central point where all cable ends meet for the installation of local networks, in building and floor wiring as well as for the connection of terminal devices. The 19" network distributors are available in wall distributor or floor distributor versions.

The cabinets can be expanded to products in the area of data centres, servers and network technology. The design of the network cabinets allows the build-in of servers with special dimensions and standards. Active and passive components, a power supply and distribution system, an ingenious cable management system and a scalable thermal management system ensure high operational reliability. The thermal management system is an important component in effective heat dissipation for electronic assemblies. The 19" ups-system (uninterruptible power supply) ensure reliable operation of systems.

In addition, we are also happy to provide tailor-made solutions to meet your individual needs. In this case, the cabinets are then equipped with the appropriate gear. In this way, you are provided with an individually configured product designed to meet your specific needs.



## Measurement & Processing Technics



In addition to the attenuation coefficients of the fibre optic cable, the attenuation values of the connection points must be carefully observed when planning a fibre optic network. In view of the high demands posed by present-day transmission processes, it is particularly important to work toward optimising connection points with regard to their attenuation values. To achieve this goal, a thermal splice process has been used. In this process, direct splicing is carried out using an arc lamp, which creates an adhesive bond between the fibres without any air gaps or inclusion of other materials. Afterwards, functionality, reliability and performance are tested using fibre optic measuring devices. The test procedures document the quality of the system, while locating sources of errors. The test protocol provides proof as to whether the cable system has been installed correctly. OTDR and performance measuring devices are used for testing. Tool cases for fibre optic cable installation and service cases for adhesives complete the professional assortment of products. For high-speed copper networks, we offer cable analysers for certification and troubleshooting.

## Active Components



For data transmission between computers, servers and PCs, both passive and active components are required. Passive elements such as wiring boxes, patch panels, cables and distributors are all permanent components of the building installation. Once they have been installed, they are no longer removed. Active components are electronic systems required for amplification, utilisation, control and transfer of data flow. Active components make it possible for workplace computers to communicate with one another as well as send, receive and understand data. The network itself is comprised of computers that are interconnected, but independent of one another while accessing common resources. According to the requirements of the costumers HELUKABEL® is supplying switches, router and media converter from well-known manufactures for the configuration of high speed networks in office environment. For the use in industrial environment there are available devices from Moxia and Hirschmann. As supplement of the wired communication wireless products can be used for new installations and for expansions of existing LAN-networks.

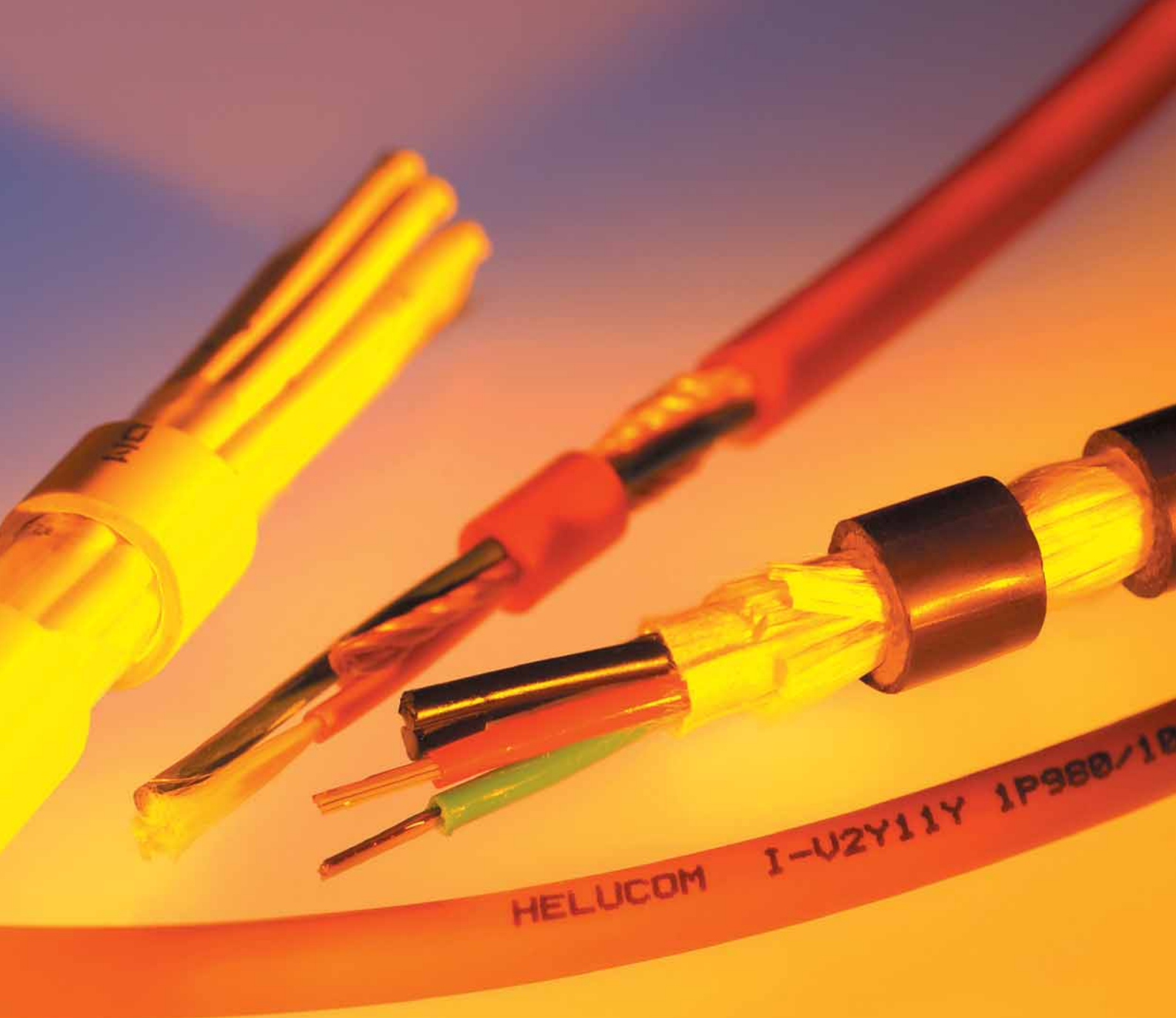

**HELUCOM pact fibre-optic universal cables A/I-DQ(ZN)BH**

Plastic-fibre cables industry I-V4Y(ZN)11Y

Fibre-optic installation cables I-VH

Fibre-optic cables with functional integrity A-DQ(ZN)BH E30

**Fibre-optic breakout cables I-V(ZN)HH**

Fibre-optic universal mini breakout cables A/I-VQ(ZN)BH

Fibre-optic aerial cables metal-free ADSS

**Fibre-optic outdoor cables A-DQ(ZN)2Y, stranded**

# FIBER OPTIC CABLES HELUCOM®

Designation			Page
<b>Indoor cables</b>			
Fibre-optic Installation cables	HELUCOM®	I-VH, I-V11Y, I-VHH, I-V11Y11Y	34
Fibre-optic breakout cables	HELUCOM®	I-V(ZN)HH	35
Fibre-optic breakout cables	HELUCOM®	I-V(ZN)H	36
Fibre-optic indoor bundle core cables	HELUCOM®	I-D(ZN)H	37
<b>Universal cables</b>			
Fibre-optic universal mini breakout cables	HELUCOM®	A/I-VQ(ZN)BH	38
Fibre-optic universal cables	HELUCOM® pact	A/I-DQ(ZN)BH	39
Fibre-optic universal cables	HELUCOM®	A/I-DQ(ZN)BH, central	40
Fibre-optic universal cables	HELUCOM®	A/I-DQ(ZN)BH, stranded	41
Fibre-optic cables with functional integrity	HELUCOM® FS30	A/I-DQ(ZN)BH	42
Fibre-optic cables with functional integrity	HELUCOM® FS90	A/I-D(ZN)BH(SR)H	43
<b>Outdoor cables</b>			
Fibre-optic outdoor cables	HELUCOM®	A-DQ(ZN)2Y, central	44
Fibre-optic outdoor cables	HELUCOM®	A-DQ(ZN)2Y, stranded	45
Fibre-optic outdoor cables	HELUCOM® pact	A-DQ(ZN)B2Y, central	46
Fibre-optic outdoor cables	HELUCOM®	A-DQ(ZN)B2Y, central	47
Fibre-optic outdoor cables	HELUCOM®	A-DQ(ZN)B2Y, stranded	48
Fibre-optic outdoor cables	HELUCOM® pact	A-DQ(ZN)B2Y fibre-combi, stranded	49
Fibre-optic outdoor cables	HELUCOM®	A-DQ(ZN)B2Y fibre-combi, stranded	50
Fibre-optic outdoor cables	HELUCOM®	A-DF(ZN)2Y	51
Fibre-optic outdoor cables	HELUCOM®	A-DF(ZN)B2Y	52
Fibre-optic outdoor cables	HELUCOM®	A-DF(ZN)2Y4Y	53
Fibre-optic outdoor cables, Microduct	HELUCOM®	A-DQ2Y, central	54
Fibre-optic outdoor cables, Microduct	HELUCOM®	A-DQ2Y, stranded	55
Fibre-optic outdoor cables	HELUCOM®	A-DQ(ZN)(SR)2Y	56
Fibre-optic outdoor cables	HELUCOM®	A-DF(ZN)2Y(SR)2Y	57
Fibre-optic outdoor cables, ARCOR	HELUCOM®	A-DF(ZN)2Y(SR)2Y	58
Fibre-optic outdoor cables hybrid	HELUCOM®	A-DSQ(ZN)B2Y	59
Fibre-optic outdoor cables hybrid	HELUCOM®	A-DSF(L)(ZN)2Y	60
<b>Aerial cables</b>			
Fibre-optic aerial cables	HELUCOM®	ADSS L	61
Fibre-optic aerial cables	HELUCOM®	ADSS	62
<b>Industry cables GOF</b>			
Fibre-optic cables flexible	HELUCOM® WK	A-V(ZN)11Y	63
Fibre-optic cables flexible	HELUCOM® WK	A-V(ZN)YY	64
Fibre-optic cables flexible	HELUCOM® WK	AT-V(ZN)H(ZN)11Y, AT-V(ZN)Y(ZN)Y	65
Fibre-optic cables flexible	HELUCOM® WK	AT-V(ZN)YY	66
Fibre-optic cables dividable	HELUCOM®	AT-V(ZN)HH(ZN)B2Y	67
Breakoutkabel PROFIBUS + PROFInet	HELUCOM®	AT-V(ZN)H(ZN)BH	68
Breakoutkabel PROFIBUS + PROFInet	HELUCOM®	AT-W(ZN)YY	69
Breakoutkabel PROFIBUS + PROFInet	HELUCOM®	AT-W(ZN)H(ZN)H	70
Breakoutkabel PROFIBUS + PROFInet	HELUCOM®	AT-W(ZN)Y(ZN)11Y	71
Breakoutkabel PROFIBUS + PROFInet	HELUCOM®	AT-V(ZN)H(ZN)BH	72
Breakoutkabel PROFIBUS + PROFInet	HELUCOM®	AT-WQ(ZN)H(ZN)B2Y	73
Fibre-optic cables robust	HELUCOM®	AT-VYY	74
<b>Industry cables HCS</b>			
Fibre-optic cables flexible	HELUCOM®	I-VH, I-VHH	75
Fibre-optic-Breakoutkabel robust, flexible	HELUCOM®	I-V(ZN)YY	76
Fibre-optic-Breakoutkabel robust, flexible	HELUCOM®	I-V(ZN)Y11Y	77
Fibre-optic-Breakoutkabel flexible	HELUCOM®	AT-V(ZN)HH	78
Fibre-optic-Breakoutkabel robust	HELUCOM®	AT-VQH(ZN)B2Y	79
Fibre-optic universal cables	HELUCOM®	A/I-DQ(ZN)BH	80
<b>Industry cables POF</b>			
Plastic-fibre cables Industry	HELUCOM®	I-V2Y, I-V2Y(ZN)11Y	81
Plastic-fibre cables PROFInet	HELUCOM®	I-V4Y(ZN)Y (Typ B), I-V4Y(ZN)11Y (Typ C)	82
Plastic-fibre cables PROFIBUS	HELUCOM®	I-V4Y(ZN)Y	83
Plastic-fibre cables Automotive	HELUCOM®	I-V4Y(ZN)11Y	84

# Fibre Optic Indoor Cable

acc. DIN VDE 0888

**HELUCOM®**

I-VH, I-V11Y, I-VHH, I-V11Y11Y

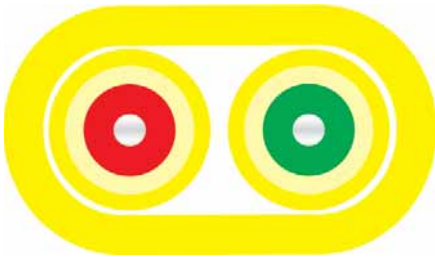

## Cable structure

Core type: Composite buffered  
Strain relief elements: Aramide  
Outer sheath material: FRNC  
Outer sheath colour: Yellow

## Temperature range

Laying, min.: 0°C  
Laying, max.: +50°C  
Operating, min.: 0°C  
Operating, max.: +60°C

## Other data

Corrosiveness acc. to EN50267-2-3  
Halogen-free acc. to 60754-2  
Flame-resistance acc. to IEC 60332-1-2  
Smoke density acc. to IEC 61034

Designation	No. of fibres	Fibre type	Fibre category	Outer Ø app. mm	Max. tensile force N	Min. stat. bending radius mm	Caloric load app. MJ / m	Max. transverse pressure N / cm	Weight kg / km	Part no.
I-VH	1	Multimode G50/125	OM2	2,6	300	40	0,17	10	8,7	<b>80783</b>
I-VH	1	Multimode G62.5/125	OM1	2,6	300	40	0,17	10	8,7	<b>80782</b>
I-VH	1	Single-mode E9/125	ITU-T G.652	2,6	300	40	0,17	10	8,7	<b>80784</b>
I-VH	2	Multimode G50/125	OM2	2,6 x 5,6	400	40	0,24	10	17,5	<b>80316</b>
I-VH	2	Multimode G50/125	OM3	2,6 x 5,6	400	40	0,24	10	17,5	<b>804256</b>
I-VH	2	Multimode G62.5/125	OM1	2,6 x 5,6	400	40	0,24	10	17,5	<b>80699</b>
I-VH	2	Single-mode E9/125	ITU-T G.652	2,6 x 5,6	400	40	0,24	10	17,5	<b>80785</b>
I-V11Y	2	Multimode G50/125	OM2	2,6 x 5,6	400	40	2,80	20	14,0	<b>82408</b>
I-V11Y	2	Multimode G62.5/125	OM1	2,6 x 5,6	400	40	2,80	20	14,0	<b>82410</b>
I-V11Y	2	Single-mode E9/125	ITU-T G.652	2,6 x 5,6	400	40	2,80	20	14,0	<b>82411</b>
I-VHH	2	Multimode G50/125	OM2	3,6 x 6,2	600	50	0,57	20	20,0	<b>80789</b>
I-VHH	2	Multimode G50/125	OM3	3,6 x 6,2	600	50	0,57	20	20,0	<b>804254</b>
I-VHH	2	Multimode G62.5/125	OM1	3,6 x 6,2	600	50	0,57	20	20,0	<b>80790</b>
I-VHH	2	Single-mode E9/125	ITU-T G.652	3,6 x 6,2	600	50	0,57	20	20,0	<b>80791</b>
I-V11Y11Y	2	Multimode G50/125	OM2	3,6 x 6,2	600	60	4,20	20	16,0	<b>82409</b>
I-V11Y11Y	2	Multimode G62.5/125	OM1	3,6 x 6,2	600	60	4,20	20	16,0	<b>81900</b>
I-V11Y11Y	2	Single-mode E9/125	ITU-T G.652	3,6 x 6,2	600	60	4,20	20	16,0	<b>82412</b>

Dimensions and specifications may be changed without prior notice.

## Application

These HELUCOM® one-fibre and two-fibre (duplex) cables are used for fixed indoor installation, such as in cable ducts. These cables are also used as ready-made cables (pigtailed) that are spliced to fixed cables or as connection cables (jumper cable) as well as for switch frames. The small diameter and the high flexibility make these cables ideal for the application in switch frames as well as for the connection of terminals.

# Fibre Optic Breakout-Cable

acc. DIN VDE 0888

HELUCOM®

I-V(ZN)HH



## Cable structure

Core type: Composite buffered  
Strain relief elements: Aramide  
Outer sheath material: FRNC  
Outer sheath colour: Yellow

## Temperature range

Laying, min.: 0°C  
Laying, max.: +50°C  
Operating, min.: 0°C  
Operating, max.: +60°C

## Other data

Corrosiveness acc. to EN50267-2-3  
Halogen-free acc. to 60754-2  
Flame-resistance acc. to IEC 60332-1 and IEC 60332-3  
Smoke density acc. to IEC 61034

Designation	No. of fibres	Fibre type	Fibre category	Number of fibres per core	Outer Ø app. mm	Max. tensile force N	Min. stat. bending radius mm	Caloric load app. MJ / m	Max. transverse pressure N / cm	Weight kg / km	Part no.
I-V(ZN)HH	2	Multimode G50/125	OM2	1	7,1	1000	270,0	1,00	150	40,0	<b>80743</b>
I-V(ZN)HH	2	Multimode G62.5/125	OM1	1	7,1	1000	270,0	1,00	150	40,0	<b>80799</b>
I-V(ZN)HH	2	Single-mode E9/125	ITU-T G.652	1	7,1	1000	270,0	1,00	150	40,0	<b>80813</b>
I-V(ZN)HH	4	Multimode G50/125	OM2	1	7,1	1000	270,0	1,00	150	45,0	<b>80753</b>
I-V(ZN)HH	4	Multimode G62.5/125	OM1	1	7,1	1000	270,0	1,00	150	45,0	<b>80800</b>
I-V(ZN)HH	4	Single-mode E9/125	ITU-T G.652	1	7,1	1000	270,0	1,00	150	45,0	<b>80814</b>
I-V(ZN)HH	6	Multimode G50/125	OM2	1	8,4	1350	270,0	1,25	150	70,0	<b>80754</b>
I-V(ZN)HH	6	Multimode G62.5/125	OM1	1	8,4	1350	270,0	1,25	150	70,0	<b>80769</b>
I-V(ZN)HH	6	Single-mode E9/125	ITU-T G.652	1	8,4	1350	270,0	1,25	150	70,0	<b>80815</b>
I-V(ZN)HH	8	Multimode G50/125	OM2	1	9,3	1500	270,0	1,50	150	100,0	<b>80688</b>
I-V(ZN)HH	8	Multimode G62.5/125	OM1	1	9,3	1500	270,0	1,50	150	100,0	<b>80801</b>
I-V(ZN)HH	8	Single-mode E9/125	ITU-T G.652	1	9,3	1500	270,0	1,50	150	100,0	<b>80816</b>
I-V(ZN)HH	12	Multimode G50/125	OM2	1	9,6	2350	270,0	1,85	150	165,0	<b>80795</b>
I-V(ZN)HH	12	Multimode G62.5/125	OM1	1	9,6	2350	270,0	1,85	150	165,0	<b>80803</b>
I-V(ZN)HH	12	Single-mode E9/125	ITU-T G.652	1	9,6	2350	270,0	1,85	150	165,0	<b>80818</b>
I-V(ZN)HH	16	Multimode G50/125	OM2	1	15,0	2400	270,0	2,40	150	170,0	<b>80796</b>
I-V(ZN)HH	16	Multimode G62.5/125	OM1	1	15,0	2400	270,0	2,40	150	170,0	<b>80804</b>
I-V(ZN)HH	16	Single-mode E9/125	ITU-T G.652	1	15,0	2400	270,0	2,40	150	170,0	<b>80819</b>
I-V(ZN)HH	24	Multimode G50/125	OM2	1	17,5	2400	330,0	3,20	150	220,0	<b>80798</b>
I-V(ZN)HH	24	Multimode G62.5/125	OM1	1	17,5	2400	330,0	3,20	150	220,0	<b>80806</b>
I-V(ZN)HH	24	Single-mode E9/125	ITU-T G.652	1	17,5	2400	320,0	3,20	150	220,0	<b>80821</b>

Dimensions and specifications may be changed without prior notice.

## Application

HELUCOM® breakout cables are designed to replace splicing on-site. They are mainly used in indoor applications for small and medium transmission lines. The fibre-optic connectors are mounted directly to the individual cables. Therefore no splicing and no splice boxes are necessary. Pre-assembled cables only need to be laid on site and are immediately functional.

# Fibre Optic Minibreakout Cable

acc. DIN VDE 0888

HELUCOM®

I-V(ZN)H



## Cable structure

Core type: Tight buffer  
Strain relief elements: Aramide  
Outer sheath material: FRNC  
Outer sheath colour: Orange

## Temperature range

Laying, min.: -5°C  
Laying, max.: +50°C  
Operating, min.: -10°C  
Operating, max.: +60°C

## Other data

Corrosiveness acc. to EN50267-2-3  
Halogen-free acc. to 60754-2  
Flame-resistance acc. to IEC 60332-1-2  
Smoke density acc. to IEC 61034

Designation	No. of fibres	Fibre type	Fibre category	Number of fibres per core	Outer Ø app. mm	Max. tensile force N	Min. stat. bending radius mm	Caloric load app. MJ / m	Max. transverse pressure N / cm	Weight kg / km	Part no.
I-V(ZN)H	2	Multimode G50/125	OM2	1	4,0	400	60,0	0,24	40	15,0	<b>80435</b>
I-V(ZN)H	2	Multimode G62.5/125	OM1	1	4,0	400	60,0	0,24	40	15,0	<b>80434</b>
I-V(ZN)H	2	Single-mode E9/125	ITU-T G.652	1	4,0	400	60,0	0,24	40	15,0	<b>80433</b>
I-V(ZN)H	4	Multimode G50/125	OM2	1	4,8	400	70,0	0,31	40	19,0	<b>80432</b>
I-V(ZN)H	4	Multimode G62.5/125	OM1	1	4,8	400	70,0	0,31	40	19,0	<b>80431</b>
I-V(ZN)H	4	Single-mode E9/125	ITU-T G.652	1	4,8	400	70,0	0,31	40	19,0	<b>80430</b>
I-V(ZN)H	6	Multimode G50/125	OM2	1	5,3	400	80,0	0,35	40	23,0	<b>80429</b>
I-V(ZN)H	6	Multimode G62.5/125	OM1	1	5,3	400	80,0	0,35	40	23,0	<b>80428</b>
I-V(ZN)H	6	Single-mode E9/125	ITU-T G.652	1	5,3	400	80,0	0,35	40	23,0	<b>80427</b>
I-V(ZN)H	8	Multimode G50/125	OM2	1	5,3	500	80,0	0,40	40	25,0	<b>80426</b>
I-V(ZN)H	8	Multimode G62.5/125	OM1	1	5,3	500	80,0	0,40	40	25,0	<b>80425</b>
I-V(ZN)H	8	Single-mode E9/125	ITU-T G.652	1	5,3	500	80,0	0,40	40	25,0	<b>80424</b>
I-V(ZN)H	10	Multimode G50/125	OM2	1	6,0	600	90,0	0,53	40	32,0	<b>80423</b>
I-V(ZN)H	10	Multimode G62.5/125	OM1	1	6,0	600	90,0	0,53	40	32,0	<b>80422</b>
I-V(ZN)H	10	Single-mode E9/125	ITU-T G.652	1	6,0	600	90,0	0,53	40	32,0	<b>80421</b>
I-V(ZN)H	12	Multimode G50/125	OM2	1	7,0	800	110,0	0,61	40	40,0	<b>80420</b>
I-V(ZN)H	12	Multimode G62.5/125	OM1	1	7,0	800	110,0	0,61	40	40,0	<b>80419</b>
I-V(ZN)H	12	Single-mode E9/125	ITU-T G.652	1	7,0	800	110,0	0,61	40	40,0	<b>80418</b>

Dimensions and specifications may be changed without prior notice.

## Application

These HELUCOM® fibre-optic cables are used for the data network cabling in indoor applications. A big advantage of this cable type is its space-saving construction. Similar to the breakout cable, the connector is directly mounted at the tight buffer.

# Fibre Optic Indoor Cable

acc. DIN VDE 0888

**HELUCOM**<sup>®</sup>

I-D(ZN)H

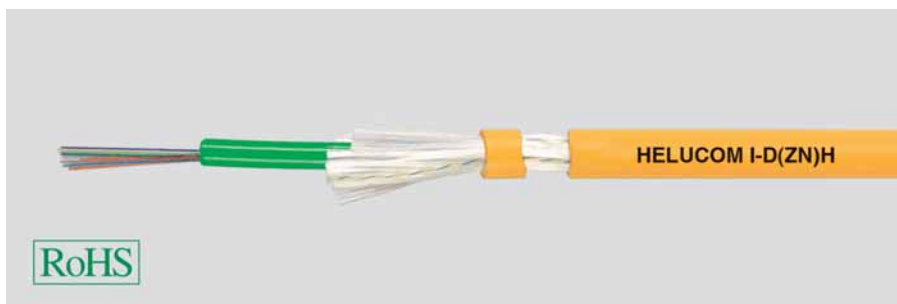

## Cable structure

Core type: Loose tube  
Strain relief elements: Aramide  
Outer sheath material: FRNC  
Outer sheath colour: Yellow

## Temperature range

Laying, min.: -5°C  
Laying, max.: +50°C  
Operating, min.: -20°C  
Operating, max.: +60°C

## Other data

Corrosiveness acc. to EN50267-2-3  
Halogen-free acc. to 60754-2  
Flame-resistance acc. to IEC 60332-1-2  
Smoke density acc. to IEC 61034

Designation	No. of fibres	Fibre type	Fibre category	Number of fibres per core	Outer Ø app. mm	Max. tensile force N	Min. stat. bending radius mm	Caloric load app. MJ / m	Max. transverse pressure N / cm	Weight kg / km	Part no.
I-D(ZN)H	4	Multimode G50/125	OM2	4	8,0	1200	120,0	1,50	150	65,0	<b>80631</b>
I-D(ZN)H	4	Multimode G62.5/125	OM1	4	8,0	1200	120,0	1,50	150	65,0	<b>80882</b>
I-D(ZN)H	4	Single-mode E9/125	ITU-T G.652	4	8,0	1200	120,0	1,50	150	65,0	<b>80896</b>
I-D(ZN)H	6	Multimode G50/125	OM2	6	8,0	1200	120,0	1,50	150	65,0	<b>80868</b>
I-D(ZN)H	6	Multimode G62.5/125	OM1	6	8,0	1200	120,0	1,50	150	65,0	<b>80883</b>
I-D(ZN)H	6	Single-mode E9/125	ITU-T G.652	6	8,0	1200	120,0	1,50	150	65,0	<b>80897</b>
I-D(ZN)H	8	Multimode G50/125	OM2	8	8,0	1200	120,0	1,50	150	65,0	<b>80869</b>
I-D(ZN)H	8	Multimode G62.5/125	OM1	8	8,0	1200	120,0	1,50	150	65,0	<b>80884</b>
I-D(ZN)H	8	Single-mode E9/125	ITU-T G.652	8	8,0	1200	120,0	1,50	150	65,0	<b>80898</b>
I-D(ZN)H	10	Multimode G50/125	OM2	10	8,0	1200	120,0	1,50	150	65,0	<b>80793</b>
I-D(ZN)H	10	Multimode G62.5/125	OM1	10	8,0	1200	120,0	1,50	150	65,0	<b>80885</b>
I-D(ZN)H	10	Single-mode E9/125	ITU-T G.652	10	8,0	1200	120,0	1,50	150	65,0	<b>80899</b>
I-D(ZN)H	12	Multimode G50/125	OM2	12	8,0	1200	120,0	1,50	150	65,0	<b>80045</b>
I-D(ZN)H	12	Multimode G62.5/125	OM1	12	8,0	1200	120,0	1,50	150	65,0	<b>80879</b>
I-D(ZN)H	12	Single-mode E9/125	ITU-T G.652	12	8,0	1200	120,0	1,50	150	65,0	<b>80880</b>
I-D(ZN)H	16	Multimode G50/125	OM2	16	8,0	1200	120,0	1,50	150	135,0	<b>80870</b>
I-D(ZN)H	16	Multimode G62.5/125	OM1	16	8,0	1200	120,0	1,50	150	135,0	<b>80886</b>
I-D(ZN)H	16	Single-mode E9/125	ITU-T G.652	16	8,0	1200	120,0	1,50	150	135,0	<b>80900</b>
I-D(ZN)H	24	Multimode G50/125	OM2	12	12,5	3000	190,0	2,20	200	150,0	<b>80872</b>
I-D(ZN)H	24	Multimode G50/125	OM2	24	9,0	1600	140,0	1,50	150	135,0	<b>80871</b>
I-D(ZN)H	24	Multimode G62.5/125	OM1	12	12,5	3000	190,0	2,20	200	150,0	<b>80888</b>
I-D(ZN)H	24	Multimode G62.5/125	OM1	24	9,0	1600	140,0	1,50	150	135,0	<b>81246</b>
I-D(ZN)H	24	Single-mode E9/125	ITU-T G.652	12	12,5	3000	190,0	2,20	200	150,0	<b>80902</b>
I-D(ZN)H	24	Single-mode E9/125	ITU-T G.652	24	9,0	1600	140,0	1,50	150	135,0	<b>80901</b>
I-D(ZN)H	36	Multimode G50/125	OM2	12	13,5	3000	200,0	2,20	200	160,0	<b>80875</b>
I-D(ZN)H	36	Multimode G62.5/125	OM1	12	13,5	3000	200,0	2,20	200	160,0	<b>80891</b>
I-D(ZN)H	36	Single-mode E9/125	ITU-T G.652	12	13,5	3000	200,0	2,20	200	160,0	<b>80905</b>
I-D(ZN)H	48	Multimode G50/125	OM2	12	13,5	3000	200,0	2,20	200	160,0	<b>80877</b>
I-D(ZN)H	48	Multimode G62.5/125	OM1	12	13,5	3000	200,0	2,20	200	160,0	<b>80893</b>
I-D(ZN)H	48	Single-mode E9/125	ITU-T G.652	12	13,5	3000	200,0	2,20	200	160,0	<b>80907</b>
I-D(ZN)H	60	Multimode G50/125	OM2	12	13,5	3000	200,0	2,20	200	170,0	<b>80878</b>
I-D(ZN)H	60	Multimode G62.5/125	OM1	12	13,5	3000	200,0	2,20	200	170,0	<b>80894</b>
I-D(ZN)H	60	Single-mode E9/125	ITU-T G.652	12	13,5	3000	200,0	2,20	200	170,0	<b>80908</b>

Dimensions and specifications may be changed without prior notice.

## Application

These HELUCOM<sup>®</sup> fibre-optic cables are available either as central bundle core cable or as stranded versions. They are suitable for indoor cabling of buildings and facilities. The halogen-free version is especially suitable for the application in skyscrapers, hospitals and stores as well as in facilities with high concentration of capital goods, such as power plants, computing centers, and at locations with high security requirements, such as underground and control stations.

# Fibre Optic Indoor/Outdoor Minibreakout Cable

acc. DIN VDE 0888

**HELUCOM®**  
A/I-VQ(ZN)BH



## Cable structure

Core type: Tight buffer  
Strain relief elements: Aramide  
Type of armouring: Glass yarns  
Outer sheath material: FRNC  
Outer sheath colour: Black

## Temperature range

Laying, min.: -5°C  
Laying, max.: +50°C  
Operating, min.: -20°C  
Operating, max.: +55°C

## Other data

Corrosiveness acc. to EN50267-2-3  
Halogen-free acc. to 60754-2  
Flame-resistance acc. to IEC 60332-1-2  
Smoke density acc. to IEC 61034  
UV-resistant

Designation	No. of fibres	Fibre type	Fibre category	Number of fibres per core	Outer Ø app. mm	Max. tensile force N	Min. stat. bending radius mm	Caloric load app. MJ / m	Max. transverse pressure N / cm	Weight kg / km	Part no.
A/I-VQ(ZN)BH	4	Multimode G50/125	OM2	1	6,1	2000	90,0	0,35	40	40,0	<b>82804</b>
A/I-VQ(ZN)BH	4	Multimode G62.5/125	OM1	1	6,1	2000	90,0	0,35	40	40,0	<b>82809</b>
A/I-VQ(ZN)BH	4	Single-mode E9/125	ITU-T G.652	1	6,1	2000	90,0	0,35	40	40,0	<b>82814</b>
A/I-VQ(ZN)BH	6	Multimode G50/125	OM2	1	6,6	2000	100,0	0,41	40	47,0	<b>82805</b>
A/I-VQ(ZN)BH	6	Multimode G62.5/125	OM1	1	6,6	2000	100,0	0,41	40	47,0	<b>82810</b>
A/I-VQ(ZN)BH	6	Single-mode E9/125	ITU-T G.652	1	6,6	2000	100,0	0,41	40	47,0	<b>82815</b>
A/I-VQ(ZN)BH	8	Multimode G50/125	OM2	1	6,6	2000	100,0	0,43	40	51,0	<b>82806</b>
A/I-VQ(ZN)BH	8	Multimode G62.5/125	OM1	1	6,6	2000	100,0	0,43	40	51,0	<b>82811</b>
A/I-VQ(ZN)BH	8	Single-mode E9/125	ITU-T G.652	1	6,6	2000	100,0	0,43	40	51,0	<b>82816</b>
A/I-VQ(ZN)BH	10	Multimode G50/125	OM2	1	8,0	2000	120,0	0,61	40	65,0	<b>82807</b>
A/I-VQ(ZN)BH	10	Multimode G62.5/125	OM1	1	8,0	2000	120,0	0,61	40	65,0	<b>82812</b>
A/I-VQ(ZN)BH	10	Single-mode E9/125	ITU-T G.652	1	8,0	2000	120,0	0,61	40	65,0	<b>82817</b>
A/I-VQ(ZN)BH	12	Multimode G50/125	OM2	1	8,3	3000	125,0	0,71	40	70,0	<b>82808</b>
A/I-VQ(ZN)BH	12	Multimode G62.5/125	OM1	1	8,3	3000	125,0	0,71	40	70,0	<b>82813</b>
A/I-VQ(ZN)BH	12	Single-mode E9/125	ITU-T G.652	1	8,3	3000	125,0	0,71	40	70,0	<b>82818</b>

Dimensions and specifications may be changed without prior notice.

## Application

These HELUCOM® fibre-optic cables are used for the data network cabling in indoor and outdoor applications. With their black UV-resistant outer sheath and the non-metallic rodent protection, they are perfectly suited for outdoor use. A big advantage of this cable type is its space-saving construction. Similar to the breakout cable, the connector is directly mounted at the tight buffer.



# Fibre Optic Indoor/Outdoor Cable

acc. DIN VDE 0888

**HELUCOM<sup>®</sup> pact**  
A/I-DQ(ZN)BH



## Cable structure

Core type: Loose tube  
Strain relief elements: Glass yarns  
Type of armouring: Glass yarns  
Outer sheath material: FRNC  
Outer sheath colour: Black

## Temperature range

Laying, min.: -5°C  
Laying, max.: +50°C  
Operating, min.: -20°C  
Operating, max.: +60°C

## Other data

Corrosiveness acc. to EN50267-2-3  
Halogen-free acc. to 60754-2  
Flame-resistance acc. to IEC 60332-1-2  
Smoke density acc. to IEC 61034  
Longitudinally water-tight acc. to IEC 60794-1-2-F5  
UV-resistant

Designation	No. of fibres	Fibre type	Fibre category	Number of fibres per core	Outer Ø app. mm	Max. tensile force N	Min. stat. bending radius mm	Caloric load app. MJ / m	Max. transverse pressure N / cm	Weight kg / km	Part no.
A/I-DQ(ZN)BH	4	Multimode G50/125	OM2	4	7,5	1500	150,0	1,10	200	55,0	<b>82792</b>
A/I-DQ(ZN)BH	4	Multimode G50/125	OM3	4	7,5	1500	150,0	1,10	200	55,0	<b>802247</b>
A/I-DQ(ZN)BH	4	Multimode G62.5/125	OM1	4	7,5	1500	150,0	1,10	200	55,0	<b>82796</b>
A/I-DQ(ZN)BH	4	Single-mode E9/125	ITU-T G.652	4	7,5	1500	150,0	1,10	200	55,0	<b>82800</b>
A/I-DQ(ZN)BH	6	Multimode G50/125	OM2	6	7,5	1500	150,0	1,10	200	55,0	<b>82793</b>
A/I-DQ(ZN)BH	6	Multimode G50/125	OM3	6	7,5	1500	150,0	1,10	200	55,0	<b>802277</b>
A/I-DQ(ZN)BH	6	Multimode G62.5/125	OM1	6	7,5	1500	150,0	1,10	200	55,0	<b>82797</b>
A/I-DQ(ZN)BH	6	Single-mode E9/125	ITU-T G.652	6	7,5	1500	150,0	1,10	200	55,0	<b>82801</b>
A/I-DQ(ZN)BH	8	Multimode G50/125	OM2	8	7,5	1500	150,0	1,10	200	55,0	<b>82794</b>
A/I-DQ(ZN)BH	8	Multimode G50/125	OM3	8	7,5	1500	150,0	1,10	200	55,0	<b>802278</b>
A/I-DQ(ZN)BH	8	Multimode G62.5/125	OM1	8	7,5	1500	150,0	1,10	200	55,0	<b>82798</b>
A/I-DQ(ZN)BH	8	Single-mode E9/125	ITU-T G.652	8	7,5	1500	150,0	1,10	200	55,0	<b>82802</b>
A/I-DQ(ZN)BH	12	Multimode G50/125	OM2	12	7,5	1500	150,0	1,10	200	55,0	<b>82795</b>
A/I-DQ(ZN)BH	12	Multimode G50/125	OM3	12	7,5	1500	150,0	1,10	200	55,0	<b>802248</b>
A/I-DQ(ZN)BH	12	Multimode G50/125	OM4	12	7,5	1500	150,0	1,10	200	55,0	<b>804705</b>
A/I-DQ(ZN)BH	12	Multimode G62.5/125	OM1	12	7,5	1500	150,0	1,10	200	55,0	<b>82799</b>
A/I-DQ(ZN)BH	12	Single-mode E9/125	ITU-T G.652	12	7,5	1500	150,0	1,10	200	55,0	<b>82803</b>
A/I-DQ(ZN)BH	24	Multimode G50/125	OM2	24	8,5	1500	170,0	1,40	200	75,0	<b>802143</b>
A/I-DQ(ZN)BH	24	Multimode G50/125	OM3	24	8,5	1500	170,0	1,40	200	75,0	<b>802249</b>
A/I-DQ(ZN)BH	24	Multimode G50/125	OM4	24	8,5	1500	170,0	1,40	200	75,0	<b>804706</b>
A/I-DQ(ZN)BH	24	Multimode G62.5/125	OM1	24	8,5	1500	170,0	1,40	200	75,0	<b>802144</b>
A/I-DQ(ZN)BH	24	Single-mode E9/125	ITU-T G.652	24	8,5	1500	170,0	1,40	200	75,0	<b>802145</b>

Dimensions and specifications may be changed without prior notice.

## Application

These HELUCOM<sup>®</sup> pact fibre-optic cables have a small but robust construction. They are suitable for indoor and outdoor cabling of buildings and facilities when space is an important argument. They are used in particular if the installation is to be done in one piece from the inside to the outside without additional use of couplings. With their black UV-resistant outer sheath and the non-metallic rodent protection, they are perfectly suited for outdoor use. The halogen-free outer sheath makes installation inhouse possible without any problems.

# Fibre Optic Indoor/Outdoor Cable

acc. DIN VDE 0888

**HELUCOM**<sup>®</sup>

A/I-DQ(ZN)BH, central



## Cable structure

Core type: Loose tube  
Strain relief elements: Glass yarns  
Type of armouring: Glass yarns  
Outer sheath material: FRNC  
Outer sheath colour: Black

## Temperature range

Laying, min.: -5°C  
Laying, max.: +50°C  
Operating, min.: -20°C  
Operating, max.: +60°C

## Other data

Corrosiveness acc. to EN50267-2-3  
Halogen-free acc. to 60754-2  
Flame-resistance acc. to IEC 60332-1-2  
Smoke density acc. to IEC 61034  
Longitudinally water-tight acc. to IEC 60794-1-2-F5  
UV-resistant

Designation	No. of fibres	Fibre type	Fibre category	Number of fibres per core	Outer Ø app. mm	Max. tensile force N	Min. stat. bending radius mm	Caloric load app. MJ / m	Max. transverse pressure N / cm	Weight kg / km	Part no.
A/I-DQ(ZN)BH	4	Multimode G50/125	OM2	4	10,0	2500	150,0	1,50	300	75,0	<b>80270</b>
A/I-DQ(ZN)BH	4	Multimode G62.5/125	OM1	4	10,0	2500	150,0	1,50	300	75,0	<b>80276</b>
A/I-DQ(ZN)BH	4	Single-mode E9/125	ITU-T G.652	4	10,0	2500	150,0	1,50	300	75,0	<b>80264</b>
A/I-DQ(ZN)BH	6	Multimode G50/125	OM2	6	10,0	2500	150,0	1,50	300	75,0	<b>80271</b>
A/I-DQ(ZN)BH	6	Multimode G62.5/125	OM1	6	10,0	2500	150,0	1,50	300	75,0	<b>80265</b>
A/I-DQ(ZN)BH	6	Single-mode E9/125	ITU-T G.652	6	10,0	2500	150,0	1,50	300	75,0	<b>80272</b>
A/I-DQ(ZN)BH	8	Multimode G50/125	OM2	8	10,0	2500	150,0	1,50	300	75,0	<b>80273</b>
A/I-DQ(ZN)BH	8	Multimode G62.5/125	OM1	8	10,0	2500	150,0	1,50	300	75,0	<b>80274</b>
A/I-DQ(ZN)BH	8	Single-mode E9/125	ITU-T G.652	8	10,0	2500	150,0	1,50	300	75,0	<b>80275</b>
A/I-DQ(ZN)BH	12	Multimode G50/125	OM2	12	10,0	2500	150,0	1,50	300	75,0	<b>80681</b>
A/I-DQ(ZN)BH	12	Multimode G62.5/125	OM1	12	10,0	2500	150,0	1,50	300	75,0	<b>80278</b>
A/I-DQ(ZN)BH	12	Single-mode E9/125	ITU-T G.652	12	10,0	2500	150,0	1,50	300	75,0	<b>80279</b>
A/I-DQ(ZN)BH	16	Multimode G50/125	OM2	16	10,0	2500	150,0	1,50	300	85,0	<b>80280</b>
A/I-DQ(ZN)BH	16	Multimode G62.5/125	OM1	16	10,0	2500	150,0	1,50	300	85,0	<b>80281</b>
A/I-DQ(ZN)BH	16	Single-mode E9/125	ITU-T G.652	16	10,0	2500	150,0	1,50	300	85,0	<b>80851</b>
A/I-DQ(ZN)BH	24	Multimode G50/125	OM2	24	10,0	2500	150,0	1,50	300	85,0	<b>80725</b>
A/I-DQ(ZN)BH	24	Multimode G62.5/125	OM1	24	10,0	2500	150,0	1,50	300	85,0	<b>82431</b>

Dimensions and specifications may be changed without prior notice.

## Application

These HELUCOM<sup>®</sup> fibre-optic cables are available either as central bundle core cable or as stranded versions. They are suitable for indoor and outdoor cabling of buildings and facilities. They are used in particular if the installation is to be done in one piece from the inside to the outside without additional use of couplings. With their black UV-resistant outer sheath and the non-metallic rodent protection, they are perfectly suited for outdoor use. The halogen-free outer sheath makes installation inhouse possible without any problems.

# Fibre Optic Indoor/Outdoor Cable

acc. DIN VDE 0888

**HELUCOM®**  
A/I-DQ(ZN)BH, stranded



## Cable structure

Core type: Loose tube  
GRP support element  
Strain relief elements: Glass yarns  
Type of armouring: Glass yarns  
Outer sheath material: FRNC  
Outer sheath colour: Black

## Temperature range

Laying, min.: -5°C  
Laying, max.: +50°C  
Operating, min.: -20°C  
Operating, max.: +60°C

## Other data

Corrosiveness acc. to EN50267-2-3  
Halogen-free acc. to 60754-2  
Flame-resistance acc. to IEC 60332-1-2  
Smoke density acc. to IEC 61034  
Longitudinally water-tight acc. to IEC 60794-1-2-F5  
UV-resistant

Designation	No. of fibres	Fibre type	Fibre category	Number of fibres per core	Outer Ø app. mm	Max. tensile force N	Min. stat. bending radius mm	Caloric load app. MJ / m	Max. transverse pressure N / cm	Weight kg / km	Part no.
A/I-DQ(ZN)BH	24	Multimode G50/125	OM2	12	11,0	2700	165,0	2,00	600	90,0	<b>81495</b>
A/I-DQ(ZN)BH	24	Multimode G62.5/125	OM1	12	11,0	2700	165,0	2,00	600	90,0	<b>802263</b>
A/I-DQ(ZN)BH	24	Single-mode E9/125	ITU-T G.652	12	11,0	2700	165,0	2,00	600	90,0	<b>80846</b>
A/I-DQ(ZN)BH	24	Multimode G50/125	OM3	12	11,0	2700	165,0	2,00	600	90,0	<b>801616</b>
A/I-DQ(ZN)BH	48	Multimode G50/125	OM2	12	11,0	2700	165,0	2,00	600	90,0	<b>802261</b>
A/I-DQ(ZN)BH	48	Multimode G50/125	OM3	12	11,0	2700	165,0	2,00	600	90,0	<b>802280</b>
A/I-DQ(ZN)BH	48	Multimode G62.5/125	OM1	12	11,0	2700	165,0	2,00	600	90,0	<b>802264</b>
A/I-DQ(ZN)BH	48	Single-mode E9/125	ITU-T G.652	12	11,0	2700	165,0	2,00	600	90,0	<b>802266</b>
A/I-DQ(ZN)BH	60	Multimode G50/125	OM2	12	11,0	2700	165,0	2,00	600	90,0	<b>802262</b>
A/I-DQ(ZN)BH	60	Multimode G62.5/125	OM1	12	11,0	2700	165,0	2,00	600	90,0	<b>802265</b>
A/I-DQ(ZN)BH	60	Single-mode E9/125	ITU-T G.652	12	11,0	2700	165,0	2,00	600	90,0	<b>802267</b>
A/I-DQ(ZN)BH	72	Multimode G50/125	OM2	12	11,5	2700	175,0	2,10	600	100,0	<b>802268</b>
A/I-DQ(ZN)BH	72	Multimode G62.5/125	OM1	12	11,5	2700	175,0	2,10	600	100,0	<b>802271</b>
A/I-DQ(ZN)BH	72	Single-mode E9/125	ITU-T G.652	12	11,5	2700	175,0	2,10	600	100,0	<b>802274</b>
A/I-DQ(ZN)BH	84	Multimode G50/125	OM2	12	12,5	3000	190,0	2,40	600	130,0	<b>802269</b>
A/I-DQ(ZN)BH	84	Multimode G62.5/125	OM1	12	12,5	3000	190,0	2,40	600	130,0	<b>802272</b>
A/I-DQ(ZN)BH	84	Single-mode E9/125	ITU-T G.652	12	12,5	3000	190,0	2,40	600	130,0	<b>802275</b>
A/I-DQ(ZN)BH	96	Multimode G50/125	OM2	12	12,5	3000	190,0	2,80	600	130,0	<b>802270</b>
A/I-DQ(ZN)BH	96	Multimode G62.5/125	OM1	12	12,5	3000	190,0	2,80	600	130,0	<b>802273</b>
A/I-DQ(ZN)BH	96	Single-mode E9/125	ITU-T G.652	12	12,5	3000	190,0	2,80	600	130,0	<b>802276</b>

Dimensions and specifications may be changed without prior notice.

## Application

These HELUCOM® fibre-optic cables are available either as central bundle core cable or as stranded versions. They are suitable for indoor and outdoor cabling of buildings and facilities. They are used in particular if the installation is to be done in one piece from the inside to the outside without additional use of couplings. With their black UV-resistant outer sheath and the non-metallic rodent protection, they are perfectly suited for outdoor use. The halogen-free outer sheath makes installation inhouse possible without any problems.

# Fibre Optic Cable with Functionality

with reference to DIN 4102-12

HELUCOM® FS30

A/I-DQ(ZN)BH



## Cable structure

Core type: Loose tube  
Strain relief elements: Aramide  
Type of armouring: Glass yarns  
Outer sheath material: FR/LSOH  
Outer sheath colour: Red

## Temperature range

Laying, min.: -10°C  
Laying, max.: +50°C  
Operating, min.: -25°C  
Operating, max.: +60°C

## Other data

Corrosiveness acc. to EN50267-2-3  
Halogen-free acc. to 60754-2  
Flame-resistance acc. to IEC 60332-1-2  
Smoke density acc. to IEC 61034  
Longitudinally water-tight acc. to IEC 60794-1-2-F5  
UV-resistant  
Functional integrity: E30

Designation	No. of fibres	Fibre type	Fibre category	Number of fibres per core	Outer Ø app. mm	Max. tensile force N	Min. stat. bending radius mm	Caloric load app. MJ / m	Max. transverse pressure N / cm	Weight kg / km	Part no.
A/I-DQ(ZN)BH	4	Multimode G50/125	OM2	4	7,8	1000	80,0	1,08	200	102,0	<b>801217</b>
A/I-DQ(ZN)BH	4	Multimode G62.5/125	OM1	4	7,8	1000	80,0	1,08	200	102,0	<b>801218</b>
A/I-DQ(ZN)BH	4	Single-mode E9/125	ITU-T G.652	4	7,8	1000	80,0	1,08	200	102,0	<b>801219</b>
A/I-DQ(ZN)BH	12	Multimode G50/125	OM2	12	7,8	1000	80,0	1,08	200	102,0	<b>801220</b>
A/I-DQ(ZN)BH	12	Multimode G62.5/125	OM1	12	7,8	1000	80,0	1,08	200	102,0	<b>801221</b>
A/I-DQ(ZN)BH	12	Single-mode E9/125	ITU-T G.652	12	7,8	1000	80,0	1,08	200	102,0	<b>801190</b>

Dimensions and specifications may be changed without prior notice.

## Application

With the serie HELUCOM® E30 we have realized, based on a special construction and high quality raw materials, a functional integrity according to DIN 4102-12 E30 (30 minutes). Together with the planned accessories the cables realize the full function of the communication in areas like tunnels or buildings for the defined period of time. On request we also can deliver cables with more than 12 fibres as stranded construction.

# Fibre Optic Cable with Functionality

with reference to IEC 60331-25

HELUCOM® FS90

A/I-D(ZN)BH(SR)H



## Cable structure

Core type: Loose tube  
 Strain relief elements: Glass yarns  
 Inner sheath material: FRNC  
 Type of armouring: steel tape  
 Outer sheath material: FR/LSOH  
 Outer sheath colour: Black

## Temperature range

Laying, min.: -5°C  
 Laying, max.: +50°C  
 Operating, min.: -20°C  
 Operating, max.: +70°C

## Other data

Corrosiveness acc. to EN50267-2-3  
 Halogen-free acc. to 60754-2  
 Flame-resistance acc. to IEC 60332-1 and -3  
 Smoke density acc. to IEC 61034  
 Longitudinally water-tight acc. to IEC 60794-1-2-F5  
 Cable, laterally water-tight  
 UV-resistant  
 Functional integrity: IEC 60794/ IEC 60331-25

Designation	No. of fibres	Fibre type	Fibre category	Number of fibres per core	Outer Ø app. mm	Max. tensile force N	Min. stat. bending radius mm	Caloric load app. MJ / m	Max. transverse pressure N / cm	Weight kg / km	Part no.
A/I-D(ZN)BH(SR)H	4	Multimode G50/125	OM2	4	12,7	1500	180,0	6,20	300	216,0	<b>803917</b>
A/I-D(ZN)BH(SR)H	4	Single-mode E9/125	ITU-T G.652	4	12,7	1500	180,0	6,20	300	216,0	<b>803919</b>
A/I-D(ZN)BH(SR)H	12	Multimode G50/125	OM2	12	12,7	1500	180,0	6,20	300	216,0	<b>803918</b>
A/I-D(ZN)BH(SR)H	12	Single-mode E9/125	ITU-T G.652	12	12,7	1500	180,0	6,20	300	216,0	<b>803920</b>

Dimensions and specifications may be changed without prior notice.

## Application

With the serie HELUCOM® FS90 we have realized, based on a special construction and high quality raw materials, a functional integrity according to IEC 60331-25 within 90, minutes (up to 750°C). Together with the planned accessories the cables realize the full function of the communication in areas like tunnels or buildings for the defined period of time.

# Fibre Optic Outdoor Cable

acc. DIN VDE 0888

**HELUCOM**<sup>®</sup>

A-DQ(ZN)2Y, central



## Cable structure

Core type: Loose tube  
Strain relief elements: Glass yarns  
Outer sheath material: PE  
Outer sheath colour: Black

## Temperature range

Laying, min.: -5°C  
Laying, max.: +50°C  
Operating, min.: -20°C  
Operating, max.: +60°C

## Other data

Corrosiveness acc. to EN50267-2-3  
Halogen-free acc. to 60754-2  
Longitudinally water-tight acc. to IEC 60794-1-2-F5  
UV-resistant

Designation	No. of fibres	Fibre type	Fibre category	Number of fibres per core	Outer Ø app. mm	Max. tensile force N	Min. stat. bending radius mm	Caloric load app. MJ / m	Max. transverse pressure N / cm	Weight kg / km	Part no.
A-DQ(ZN)2Y	2	Multimode G50/125	OM2	2	8,8	1500	130,0	1,60	250	40,0	<b>80148</b>
A-DQ(ZN)2Y	2	Multimode G62.5/125	OM1	2	8,8	1500	130,0	1,60	250	40,0	<b>80164</b>
A-DQ(ZN)2Y	2	Single-mode E9/125	ITU-T G.652	2	8,8	1500	130,0	1,60	250	40,0	<b>80131</b>
A-DQ(ZN)2Y	4	Multimode G50/125	OM2	4	8,8	1500	130,0	1,60	250	40,0	<b>80149</b>
A-DQ(ZN)2Y	4	Multimode G62.5/125	OM1	4	8,8	1500	130,0	1,60	250	40,0	<b>80165</b>
A-DQ(ZN)2Y	4	Single-mode E9/125	ITU-T G.652	4	8,8	1500	130,0	1,60	250	40,0	<b>80132</b>
A-DQ(ZN)2Y	6	Multimode G50/125	OM2	6	8,8	1500	130,0	1,60	250	40,0	<b>80150</b>
A-DQ(ZN)2Y	6	Multimode G62.5/125	OM1	6	8,8	1500	130,0	1,60	250	40,0	<b>80166</b>
A-DQ(ZN)2Y	6	Single-mode E9/125	ITU-T G.652	6	8,8	1500	130,0	1,60	250	40,0	<b>80133</b>
A-DQ(ZN)2Y	8	Multimode G50/125	OM2	8	8,8	1500	130,0	1,60	250	40,0	<b>80151</b>
A-DQ(ZN)2Y	8	Multimode G62.5/125	OM1	8	8,8	1500	130,0	1,60	250	40,0	<b>80167</b>
A-DQ(ZN)2Y	8	Single-mode E9/125	ITU-T G.652	8	8,8	1500	130,0	1,60	250	40,0	<b>80134</b>
A-DQ(ZN)2Y	12	Multimode G50/125	OM2	12	8,8	1500	130,0	1,60	250	40,0	<b>80153</b>
A-DQ(ZN)2Y	12	Multimode G62.5/125	OM1	12	8,8	1500	130,0	1,60	250	40,0	<b>80169</b>
A-DQ(ZN)2Y	12	Single-mode E9/125	ITU-T G.652	12	8,8	1500	130,0	1,60	250	40,0	<b>80136</b>
A-DQ(ZN)2Y	16	Multimode G50/125	OM2	16	8,8	1500	130,0	1,80	250	70,0	<b>80154</b>
A-DQ(ZN)2Y	16	Multimode G62.5/125	OM1	16	8,8	1500	130,0	1,80	250	70,0	<b>80170</b>
A-DQ(ZN)2Y	16	Single-mode E9/125	ITU-T G.652	16	8,8	1500	130,0	1,80	250	70,0	<b>80137</b>
A-DQ(ZN)2Y	24	Multimode G50/125	OM2	24	8,8	1500	130,0	1,80	250	70,0	<b>80155</b>
A-DQ(ZN)2Y	24	Multimode G62.5/125	OM1	24	8,8	1500	130,0	1,80	250	70,0	<b>80171</b>
A-DQ(ZN)2Y	24	Single-mode E9/125	ITU-T G.652	24	8,8	1500	130,0	1,80	250	70,0	<b>80138</b>

Dimensions and specifications may be changed without prior notice.

## Application

These HELUCOM<sup>®</sup> fibre-optic cables are characterized by a design that is particularly easy to mount. Around a central grooved cable, there is a composite of glass yarns and swelling fleece with characteristics that ensure the actual strain relief and waterproofing in longitudinal direction of the cable. In addition, these cables are designed grease-free. Wiping the jelly off is therefore unnecessary. This construction is particularly used in underground, tubes and channel areas, where rodent infestation is not to be expected.

# Fibre Optic Outdoor Cable

acc. DIN VDE 0888

**HELUCOM®**

A-DQ(ZN)2Y, stranded



## Cable structure

Core type: Loose tube  
GRP support element  
Strain relief elements: Glass yarns  
Outer sheath material: PE  
Outer sheath colour: Black

## Temperature range

Laying, min.: -5°C  
Laying, max.: +50°C  
Operating, min.: -20°C  
Operating, max.: +60°C

## Other data

Corrosiveness acc. to EN50267-2-3  
Halogen-free acc. to 60754-2  
Longitudinally water-tight acc. to IEC 60794-1-2-F5  
UV-resistant

Designation	No. of fibres	Fibre type	Fibre category	Number of fibres per core	Outer Ø app. mm	Max. tensile force N	Min. stat. bending radius mm	Caloric load app. MJ / m	Max. transverse pressure N / cm	Weight kg / km	Part no.
A-DQ(ZN)2Y	24	Multimode G50/125	OM2	12	10,0	2500	200,0	2,50	400	70,0	<b>80156</b>
A-DQ(ZN)2Y	24	Multimode G62.5/125	OM1	12	10,0	2500	200,0	2,50	400	70,0	<b>80172</b>
A-DQ(ZN)2Y	24	Single-mode E9/125	ITU-T G.652	12	10,0	2500	200,0	2,50	400	70,0	<b>80139</b>
A-DQ(ZN)2Y	36	Multimode G50/125	OM2	12	10,0	2500	200,0	2,50	400	70,0	<b>80448</b>
A-DQ(ZN)2Y	36	Multimode G62.5/125	OM1	12	10,0	2500	200,0	2,50	400	70,0	<b>80449</b>
A-DQ(ZN)2Y	36	Single-mode E9/125	ITU-T G.652	12	10,0	2500	200,0	2,50	400	70,0	<b>80450</b>
A-DQ(ZN)2Y	48	Multimode G50/125	OM2	12	10,0	2500	200,0	2,50	400	70,0	<b>80447</b>
A-DQ(ZN)2Y	48	Multimode G62.5/125	OM1	12	10,0	2500	200,0	2,50	400	70,0	<b>80446</b>
A-DQ(ZN)2Y	48	Single-mode E9/125	ITU-T G.652	12	10,0	2500	200,0	2,50	400	70,0	<b>80445</b>
A-DQ(ZN)2Y	60	Multimode G50/125	OM2	12	10,0	2500	200,0	2,50	400	70,0	<b>80159</b>
A-DQ(ZN)2Y	60	Multimode G62.5/125	OM1	12	10,0	2500	200,0	2,50	400	70,0	<b>80175</b>
A-DQ(ZN)2Y	60	Single-mode E9/125	ITU-T G.652	12	10,0	2500	200,0	2,50	400	70,0	<b>80142</b>
A-DQ(ZN)2Y	72	Multimode G50/125	OM2	12	10,5	2500	210,0	2,60	400	75,0	<b>80444</b>
A-DQ(ZN)2Y	72	Multimode G62.5/125	OM1	12	10,5	2500	210,0	2,60	400	75,0	<b>80443</b>
A-DQ(ZN)2Y	72	Single-mode E9/125	ITU-T G.652	12	10,5	2500	210,0	2,60	400	75,0	<b>80442</b>
A-DQ(ZN)2Y	84	Multimode G50/125	OM2	12	11,5	2700	230,0	3,30	400	110,0	<b>80160</b>
A-DQ(ZN)2Y	84	Multimode G62.5/125	OM1	12	11,5	2700	230,0	3,30	400	110,0	<b>80176</b>
A-DQ(ZN)2Y	84	Single-mode E9/125	ITU-T G.652	12	11,5	2700	230,0	3,30	400	110,0	<b>80143</b>
A-DQ(ZN)2Y	96	Multimode G50/125	OM2	12	11,5	2700	230,0	3,30	400	110,0	<b>80441</b>
A-DQ(ZN)2Y	96	Multimode G62.5/125	OM1	12	11,5	2700	230,0	3,30	400	110,0	<b>80440</b>
A-DQ(ZN)2Y	96	Single-mode E9/125	ITU-T G.652	12	11,5	2700	230,0	3,30	400	110,0	<b>80439</b>
A-DQ(ZN)2Y	108	Multimode G50/125	OM2	12	13,0	2700	260,0	4,00	400	130,0	<b>80161</b>
A-DQ(ZN)2Y	108	Multimode G62.5/125	OM1	12	13,0	2700	260,0	4,00	400	130,0	<b>80177</b>
A-DQ(ZN)2Y	108	Single-mode E9/125	ITU-T G.652	12	13,0	2700	260,0	4,00	400	130,0	<b>80144</b>
A-DQ(ZN)2Y	120	Multimode G50/125	OM2	12	13,0	2700	260,0	4,00	400	130,0	<b>80162</b>
A-DQ(ZN)2Y	120	Multimode G62.5/125	OM1	12	13,0	2700	260,0	4,00	400	130,0	<b>80178</b>
A-DQ(ZN)2Y	120	Single-mode E9/125	ITU-T G.652	12	13,0	2700	260,0	4,00	400	130,0	<b>80146</b>
A-DQ(ZN)2Y	144	Multimode G50/125	OM2	12	14,0	2700	280,0	5,00	400	150,0	<b>80438</b>
A-DQ(ZN)2Y	144	Multimode G62.5/125	OM1	12	14,0	2700	280,0	5,00	400	150,0	<b>80437</b>
A-DQ(ZN)2Y	144	Single-mode E9/125	ITU-T G.652	12	14,0	2700	280,0	5,00	400	150,0	<b>80436</b>

Dimensions and specifications may be changed without prior notice.

## Application

These HELUCOM® fibre-optic cables are characterized by a design that is particularly easy to mount and extremely tension-resistant. Around a stranded grooved cable and filler elements, there is a swelling fleece with characteristics that ensure strain relief and waterproofing in longitudinal direction of the cable. In addition, these cables are designed grease-free. Wiping the jelly off is therefore unnecessary. This construction is particularly used in underground, tubes and channel areas, where above-average tensile stresses and/or transverse compressions occur, but rodent infestation is not to be expected.

# Fibre Optic Outdoor Cable

acc. DIN VDE 0888

**HELUCOM<sup>®</sup> pact**

A-DQ(ZN)B2Y, central



## Cable structure

Core type: Loose tube  
Strain relief elements: Glass yarns  
Type of armouring: Glass yarns  
Outer sheath material: PE  
Outer sheath colour: Black

## Temperature range

Laying, min.: -5°C  
Laying, max.: +50°C  
Operating, min.: -20°C  
Operating, max.: +60°C

## Other data

Corrosiveness acc. to EN50267-2-3  
Halogen-free acc. to 60754-2  
Longitudinally water-tight acc. to IEC 60794-1-2-F5  
UV-resistant

Designation	No. of fibres	Fibre type	Fibre category	Number of fibres per core	Outer Ø app. mm	Max. tensile force N	Min. stat. bending radius mm	Caloric load app. MJ / m	Max. transverse pressure N / cm	Weight kg / km	Part no.
A-DQ(ZN)B2Y	2	Multimode G50/125	OM2	2	7,5	1500	150,0	1,60	300	40,0	<b>800754</b>
A-DQ(ZN)B2Y	2	Multimode G62.5/125	OM1	2	7,5	1500	150,0	1,60	300	40,0	<b>802131</b>
A-DQ(ZN)B2Y	2	Single-mode E9/125	ITU-T G.652	2	7,5	1500	150,0	1,60	300	40,0	<b>802137</b>
A-DQ(ZN)B2Y	4	Multimode G50/125	OM2	4	7,5	1500	150,0	1,60	300	40,0	<b>800755</b>
A-DQ(ZN)B2Y	4	Multimode G62.5/125	OM1	4	7,5	1500	150,0	1,60	300	40,0	<b>802132</b>
A-DQ(ZN)B2Y	4	Single-mode E9/125	ITU-T G.652	4	7,5	1500	150,0	1,60	300	40,0	<b>802138</b>
A-DQ(ZN)B2Y	6	Multimode G50/125	OM2	6	7,5	1500	150,0	1,60	300	40,0	<b>800756</b>
A-DQ(ZN)B2Y	6	Multimode G62.5/125	OM1	6	7,5	1500	150,0	1,60	300	40,0	<b>802133</b>
A-DQ(ZN)B2Y	6	Single-mode E9/125	ITU-T G.652	6	7,5	1500	150,0	1,60	300	40,0	<b>802139</b>
A-DQ(ZN)B2Y	8	Multimode G50/125	OM2	8	7,5	1500	150,0	1,60	300	40,0	<b>800757</b>
A-DQ(ZN)B2Y	8	Multimode G62.5/125	OM1	8	7,5	1500	150,0	1,60	300	40,0	<b>802134</b>
A-DQ(ZN)B2Y	8	Single-mode E9/125	ITU-T G.652	8	7,5	1500	150,0	1,60	300	40,0	<b>802140</b>
A-DQ(ZN)B2Y	12	Multimode G50/125	OM2	12	7,5	1500	150,0	1,60	300	40,0	<b>800759</b>
A-DQ(ZN)B2Y	12	Multimode G62.5/125	OM1	12	7,5	1500	150,0	1,60	300	40,0	<b>802135</b>
A-DQ(ZN)B2Y	12	Single-mode E9/125	ITU-T G.652	12	7,5	1500	150,0	1,60	300	40,0	<b>802141</b>
A-DQ(ZN)B2Y	24	Multimode G50/125	OM2	24	8,5	1500	170,0	1,90	300	60,0	<b>800762</b>
A-DQ(ZN)B2Y	24	Multimode G62.5/125	OM1	24	8,5	1500	170,0	1,90	300	60,0	<b>802136</b>
A-DQ(ZN)B2Y	24	Single-mode E9/125	ITU-T G.652	24	8,5	1500	170,0	1,90	300	60,0	<b>802142</b>

Dimensions and specifications may be changed without prior notice.

## Application

These HELUCOM<sup>®</sup> pact fibre-optic cables are characterized by a design that is particularly easy to mount and is rodent-protected. Around a central grooved cable, there is a composite of glass yarns and swelling fleece with characteristics that ensure rodent protection, strain relief, and waterproofing in longitudinal direction of the cable. In addition, these cables are designed grease-free. Wiping the jelly off is therefore unnecessary. This construction is particularly used in underground, tubes and channel areas, where normal tensile stresses and/or transverse compressions occur and rodent infestation is to be expected.



# Fibre Optic Outdoor Cable

acc. DIN VDE 0888

**HELUCOM®**

A-DQ(ZN)B2Y, central



## Cable structure

Core type: Loose tube  
Strain relief elements: Glass yarns  
Type of armouring: Glass yarns  
Outer sheath material: PE  
Outer sheath colour: Black

## Temperature range

Laying, min.: -5°C  
Laying, max.: +50°C  
Operating, min.: -20°C  
Operating, max.: +60°C

## Other data

Corrosiveness acc. to EN50267-2-3  
Halogen-free acc. to 60754-2  
Longitudinally water-tight acc. to IEC 60794-1-2-F5  
UV-resistant

Designation	No. of fibres	Fibre type	Fibre category	Number of fibres per core	Outer Ø app. mm	Max. tensile force N	Min. stat. bending radius mm	Caloric load app. MJ / m	Max. transverse pressure N / cm	Weight kg / km	Part no.
A-DQ(ZN)B2Y	2	Multimode G50/125	OM2	2	10,0	2700	160,0	1,60	300	85,0	<b>80196</b>
A-DQ(ZN)B2Y	2	Multimode G62.5/125	OM1	2	10,0	2700	160,0	1,60	300	85,0	<b>80212</b>
A-DQ(ZN)B2Y	2	Single-mode E9/125	ITU-T G.652	2	10,0	2700	160,0	1,60	300	85,0	<b>80180</b>
A-DQ(ZN)B2Y	4	Multimode G50/125	OM2	4	10,0	2700	160,0	1,60	300	85,0	<b>80197</b>
A-DQ(ZN)B2Y	4	Multimode G62.5/125	OM1	4	10,0	2700	160,0	1,60	300	85,0	<b>80213</b>
A-DQ(ZN)B2Y	4	Single-mode E9/125	ITU-T G.652	4	10,0	2700	160,0	1,60	300	85,0	<b>80181</b>
A-DQ(ZN)B2Y	6	Multimode G50/125	OM2	6	10,0	2700	160,0	1,60	300	85,0	<b>80198</b>
A-DQ(ZN)B2Y	6	Multimode G62.5/125	OM1	6	10,0	2700	160,0	1,60	300	85,0	<b>80214</b>
A-DQ(ZN)B2Y	6	Single-mode E9/125	ITU-T G.652	6	10,0	2700	160,0	1,60	300	85,0	<b>80182</b>
A-DQ(ZN)B2Y	8	Multimode G50/125	OM2	8	10,0	2700	160,0	1,60	300	85,0	<b>80199</b>
A-DQ(ZN)B2Y	8	Multimode G62.5/125	OM1	8	10,0	2700	160,0	1,60	300	85,0	<b>80215</b>
A-DQ(ZN)B2Y	8	Single-mode E9/125	ITU-T G.652	8	10,0	2700	160,0	1,60	300	85,0	<b>80183</b>
A-DQ(ZN)B2Y	12	Multimode G50/125	OM2	12	10,0	2700	160,0	1,60	300	85,0	<b>80201</b>
A-DQ(ZN)B2Y	12	Multimode G62.5/125	OM1	12	10,0	2700	160,0	1,60	300	85,0	<b>80217</b>
A-DQ(ZN)B2Y	12	Single-mode E9/125	ITU-T G.652	12	10,0	2700	160,0	1,60	300	85,0	<b>80185</b>
A-DQ(ZN)B2Y	16	Multimode G50/125	OM2	16	10,0	2700	180,0	1,80	300	95,0	<b>80202</b>
A-DQ(ZN)B2Y	16	Multimode G62.5/125	OM1	16	10,0	2700	180,0	1,80	300	95,0	<b>80218</b>
A-DQ(ZN)B2Y	16	Single-mode E9/125	ITU-T G.652	16	10,0	2700	180,0	1,80	300	95,0	<b>80186</b>
A-DQ(ZN)B2Y	24	Multimode G50/125	OM2	24	10,0	2700	180,0	1,80	300	95,0	<b>80204</b>
A-DQ(ZN)B2Y	24	Multimode G62.5/125	OM1	24	10,0	2700	180,0	1,80	300	95,0	<b>80220</b>
A-DQ(ZN)B2Y	24	Single-mode E9/125	ITU-T G.652	24	10,0	2700	180,0	1,80	300	95,0	<b>80187</b>

Dimensions and specifications may be changed without prior notice.

## Application

These HELUCOM® fibre-optic cables are characterized by a design that is particularly easy to mount and is rodent-protected. Around a central grooved cable, there is a composite of glass yarns and swelling fleece with characteristics that ensure rodent protection, strain relief, and waterproofing in longitudinal direction of the cable. In addition, these cables are designed grease-free. Wiping the jelly off is therefore unnecessary. This construction is particularly used in underground, tubes and channel areas, where normal tensile stresses and/or transverse compressions occur and rodent infestation is to be expected.

# Fibre Optic Outdoor Cable

acc. DIN VDE 0888

**HELUCOM®**  
A-DQ(ZN)B2Y, stranded



## Cable structure

Core type: Loose tube  
GRP support element  
Strain relief elements: Glass yarns  
Type of armouring: Glass yarns  
Outer sheath material: PE  
Outer sheath colour: Black

## Temperature range

Laying, min.: -5°C  
Laying, max.: +50°C  
Operating, min.: -20°C  
Operating, max.: +60°C

## Other data

Corrosiveness acc. to EN50267-2-3  
Halogen-free acc. to 60754-2  
Longitudinally water-tight acc. to IEC 60794-1-2-F5  
UV-resistant

Designation	No. of fibres	Fibre type	Fibre category	Number of fibres per core	Outer Ø app. mm	Max. tensile force N	Min. stat. bending radius mm	Caloric load app. MJ / m	Max. transverse pressure N / cm	Weight kg / km	Part no.
A-DQ(ZN)B2Y	24	Multimode G50/125	OM2	12	10,5	2700	210,0	2,70	600	95,0	<b>81382</b>
A-DQ(ZN)B2Y	24	Multimode G62.5/125	OM1	12	10,5	2700	210,0	2,70	600	95,0	<b>80219</b>
A-DQ(ZN)B2Y	24	Single-mode E9/125	ITU-T G.652	12	10,5	2700	210,0	2,70	600	95,0	<b>80188</b>
A-DQ(ZN)B2Y	36	Multimode G50/125	OM2	12	10,5	2700	210,0	2,70	600	95,0	<b>81108</b>
A-DQ(ZN)B2Y	36	Multimode G62.5/125	OM1	12	10,5	2700	210,0	2,70	600	95,0	<b>81109</b>
A-DQ(ZN)B2Y	36	Single-mode E9/125	ITU-T G.652	12	10,5	2700	210,0	2,70	600	95,0	<b>81110</b>
A-DQ(ZN)B2Y	48	Multimode G50/125	OM2	12	10,5	2700	210,0	2,70	600	95,0	<b>82648</b>
A-DQ(ZN)B2Y	48	Multimode G62.5/125	OM1	12	10,5	2700	210,0	2,70	600	95,0	<b>81112</b>
A-DQ(ZN)B2Y	48	Single-mode E9/125	ITU-T G.652	12	10,5	2700	210,0	2,70	600	95,0	<b>81113</b>
A-DQ(ZN)B2Y	60	Multimode G50/125	OM2	12	10,5	2700	210,0	2,70	600	95,0	<b>80207</b>
A-DQ(ZN)B2Y	60	Multimode G62.5/125	OM1	12	10,5	2700	210,0	2,70	600	95,0	<b>80223</b>
A-DQ(ZN)B2Y	60	Single-mode E9/125	ITU-T G.652	12	10,5	2700	210,0	2,70	600	95,0	<b>80191</b>
A-DQ(ZN)B2Y	72	Multimode G50/125	OM2	12	11,0	2700	220,0	2,90	600	100,0	<b>81133</b>
A-DQ(ZN)B2Y	72	Multimode G62.5/125	OM1	12	11,0	2700	220,0	2,90	600	100,0	<b>81134</b>
A-DQ(ZN)B2Y	72	Single-mode E9/125	ITU-T G.652	12	11,0	2700	220,0	2,90	600	100,0	<b>81120</b>
A-DQ(ZN)B2Y	84	Multimode G50/125	OM2	12	12,0	3000	240,0	3,60	600	140,0	<b>80208</b>
A-DQ(ZN)B2Y	84	Multimode G62.5/125	OM1	12	12,0	3000	240,0	3,60	600	140,0	<b>80224</b>
A-DQ(ZN)B2Y	84	Single-mode E9/125	ITU-T G.652	12	12,0	3000	240,0	3,60	600	140,0	<b>80192</b>
A-DQ(ZN)B2Y	96	Multimode G50/125	OM2	12	12,0	3000	240,0	3,60	600	140,0	<b>81135</b>
A-DQ(ZN)B2Y	96	Multimode G62.5/125	OM1	12	12,0	3000	240,0	3,60	600	140,0	<b>81136</b>
A-DQ(ZN)B2Y	96	Single-mode E9/125	ITU-T G.652	12	12,0	3000	240,0	3,60	600	140,0	<b>81121</b>
A-DQ(ZN)B2Y	108	Multimode G50/125	OM2	12	13,5	3000	270,0	4,30	600	155,0	<b>80209</b>
A-DQ(ZN)B2Y	108	Multimode G62.5/125	OM1	12	13,5	3000	270,0	4,30	600	155,0	<b>80225</b>
A-DQ(ZN)B2Y	108	Single-mode E9/125	ITU-T G.652	12	13,5	3000	270,0	4,30	600	155,0	<b>80193</b>
A-DQ(ZN)B2Y	120	Multimode G50/125	OM2	12	13,5	3000	270,0	4,30	600	155,0	<b>80210</b>
A-DQ(ZN)B2Y	120	Multimode G62.5/125	OM1	12	13,5	3000	270,0	4,30	600	155,0	<b>80226</b>
A-DQ(ZN)B2Y	120	Single-mode E9/125	ITU-T G.652	12	13,5	3000	270,0	4,30	600	155,0	<b>80194</b>
A-DQ(ZN)B2Y	144	Multimode G50/125	OM2	12	14,5	3000	290,0	5,40	600	200,0	<b>80211</b>
A-DQ(ZN)B2Y	144	Multimode G62.5/125	OM1	12	14,5	3000	290,0	5,40	600	200,0	<b>80227</b>
A-DQ(ZN)B2Y	144	Single-mode E9/125	ITU-T G.652	12	14,5	3000	290,0	5,40	600	200,0	<b>80195</b>

Dimensions and specifications may be changed without prior notice.

## Application

These HELUCOM® fibre-optic cables are characterized by a design that is particularly easy to mount, extremely tension-resistant and rodent-proof. Around a stranded grooved cable and filler elements, there is a composite of glass yarns and swelling fleece with characteristics that ensure rodent protection, strain relief, and waterproofing in longitudinal direction of the cable. In addition, these cables are designed grease-free. Wiping the jelly off is therefore unnecessary. This construction is particularly used in underground, tubes and channel areas, where above-average tensile stresses and/or transverse compressions occur and rodent infestation is to be expected.

# Fibre Optic Outdoor Cable

acc. DIN VDE 0888

**HELUCOM<sup>®</sup> pact**

A-DQ(ZN)B2Y fibre combi, stranded



## Cable structure

Core type: Loose tube  
GRP support element  
Strain relief elements: Glass yarns  
Type of armouring: Glass yarns  
Outer sheath material: PE  
Outer sheath colour: Black

## Temperature range

Laying, min.: -5°C  
Laying, max.: +50°C  
Operating, min.: -20°C  
Operating, max.: +60°C

## Other data

Corrosiveness acc. to EN50267-2-3  
Longitudinally water-tight acc. to IEC 60794-1-2-F5  
UV-resistant

Designation	No. of fibres	Fibre type	Fibre category	Number of fibres per core	Outer Ø app. mm	Max. tensile force N	Min. stat. bending radius mm	Caloric load app. MJ / m	Max. transverse pressure N / cm	Weight kg / km	Part no.
A-DQ(ZN)B2Y	24	Single- and multimode G50/125	OM2 + ITU-T G.652	12	9,5	2500	200,0	2,50	400	90,0	<b>803037</b>
A-DQ(ZN)B2Y	24	Single- und Multimode G50/125 OM3	OM3 + ITU-T G.652	12	9,5	2500	200,0	2,50	400	90,0	<b>803923</b>
A-DQ(ZN)B2Y	48	Single- and multimode G50/125	OM2 + ITU-T G.652	12	9,5	2500	200,0	2,50	400	90,0	<b>803038</b>
A-DQ(ZN)B2Y	48	Single- und Multimode G50/125 OM3	OM3 + ITU-T G.652	12	9,5	2500	200,0	2,50	400	90,0	<b>803924</b>

Dimensions and specifications may be changed without prior notice.

## Application

These HELUCOM<sup>®</sup> pact fibre-optic cables are characterized by a design that is particularly easy to mount, tension-resistant and rodent-proof. Around a stranded grooved cable and filler elements, there is a composite of glass yarns and swelling fleece with characteristics that ensure rodent protection, strain relief and waterproofing in longitudinal direction of the cable. In addition, these cables are designed grease-free. Wiping the jelly off is therefore unnecessary. This construction is particularly used in underground, tubes and channel areas, where packing density also plays a role.

# Fibre Optic Outdoor Cable

acc. DIN VDE 0888

**HELUCOM**<sup>®</sup>

A-DQ(ZN)B2Y fibre combi, stranded



## Cable structure

Core type: Loose tube  
 GRP support element  
 Strain relief elements: Glass yarns  
 Type of armouring: Glass yarns  
 Outer sheath material: PE  
 Outer sheath colour: Black

## Temperature range

Laying, min.: -5°C  
 Laying, max.: +50°C  
 Operating, min.: -20°C  
 Operating, max.: +60°C

## Other data

Corrosiveness acc. to EN50267-2-3  
 Halogen-free acc. to 60754-2  
 Longitudinally water-tight acc. to IEC 60794-1-2-F5  
 UV-resistant

Designation	No. of fibres	Fibre type	Fibre category	Number of fibres per core	Outer Ø app. mm	Max. tensile force N	Min. stat. bending radius mm	Caloric load app. MJ / m	Max. transverse pressure N / cm	Weight kg / km	Part no.
A-DQ(ZN)B2Y	24	Single- and multimode G50/125	OM2 + ITU-T G.652	12	10,5	2700	200,0	2,70	600	95,0	<b>81478</b>
A-DQ(ZN)B2Y	48	Single- and multimode G50/125	OM2 + ITU-T G.652	12	10,5	2700	200,0	2,70	600	95,0	<b>801183</b>

Dimensions and specifications may be changed without prior notice.

## Application

These HELUCOM<sup>®</sup> fibre-optic cables are characterized by a design that is particularly easy to mount, extremely tension-resistant and rodent-proof. Around a stranded grooved cable and filler elements, there is a composite of glass yarns and swelling fleece with characteristics that ensure rodent protection, strain relief and waterproofing in longitudinal direction of the cable. In addition, these cables are designed grease-free. Wiping the jelly off is therefore unnecessary. This construction is particularly used in underground, tubes and channel areas, where above-average tensile stresses and/or transverse compressions occur and rodent infestation is to be expected.

# Fibre Optic Outdoor Cable

acc. DIN VDE 0888

**HELUCOM®**

A-DF(ZN)2Y

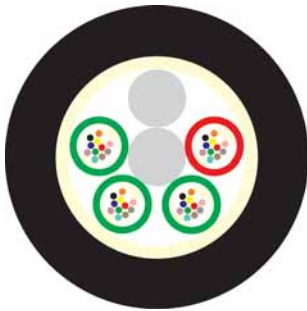

## Cable structure

Core type: Loose tube  
GRP support element  
Strain relief elements: Aramide  
Outer sheath material: PE  
Outer sheath colour: Black

## Temperature range

Laying, min.: -5°C  
Laying, max.: +50°C  
Operating, min.: -20°C  
Operating, max.: +60°C

## Other data

Corrosiveness acc. to EN50267-2-3  
Halogen-free acc. to 60754-2  
Longitudinally water-tight acc. to IEC 60794-1-2-F5  
UV-resistant

Designation	No. of fibres	Fibre type	Fibre category	Number of fibres per core	Outer Ø app. mm	Max. tensile force N	Min. stat. bending radius mm	Caloric load app. MJ / m	Max. transverse pressure N / cm	Weight kg / km	Part no.
A-DF(ZN)2Y	2	Multimode G50/125	OM2	2	9,5	2500	95,0	4,20	400	85,0	<b>80016</b>
A-DF(ZN)2Y	2	Multimode G62.5/125	OM1	2	9,5	2500	95,0	4,20	400	85,0	<b>80033</b>
A-DF(ZN)2Y	2	Single-mode E9/125	ITU-T G.652	2	9,5	2500	95,0	4,20	400	85,0	<b>80000</b>
A-DF(ZN)2Y	4	Multimode G50/125	OM2	4	9,5	2500	95,0	4,20	400	85,0	<b>80017</b>
A-DF(ZN)2Y	4	Multimode G62.5/125	OM1	4	9,5	2500	95,0	4,20	400	85,0	<b>80034</b>
A-DF(ZN)2Y	4	Single-mode E9/125	ITU-T G.652	4	9,5	2500	95,0	4,20	400	85,0	<b>80001</b>
A-DF(ZN)2Y	8	Multimode G50/125	OM2	8	9,5	2500	95,0	4,20	400	85,0	<b>80019</b>
A-DF(ZN)2Y	8	Multimode G62.5/125	OM1	8	9,5	2500	95,0	4,20	400	85,0	<b>80036</b>
A-DF(ZN)2Y	8	Single-mode E9/125	ITU-T G.652	8	9,5	2500	95,0	4,20	400	85,0	<b>80003</b>
A-DF(ZN)2Y	12	Multimode G50/125	OM2	12	9,5	2500	95,0	4,20	400	85,0	<b>80021</b>
A-DF(ZN)2Y	12	Multimode G62.5/125	OM1	12	9,5	2500	95,0	4,20	400	85,0	<b>80038</b>
A-DF(ZN)2Y	12	Single-mode E9/125	ITU-T G.652	12	9,5	2500	95,0	4,20	400	85,0	<b>80005</b>
A-DF(ZN)2Y	24	Multimode G50/125	OM2	12	9,5	2700	95,0	4,00	400	85,0	<b>80024</b>
A-DF(ZN)2Y	24	Multimode G62.5/125	OM1	12	9,5	2700	95,0	4,00	400	85,0	<b>80041</b>
A-DF(ZN)2Y	24	Single-mode E9/125	ITU-T G.652	12	9,5	2700	95,0	4,00	400	85,0	<b>80008</b>
A-DF(ZN)2Y	36	Multimode G50/125	OM2	12	9,5	2700	95,0	4,00	400	85,0	<b>80912</b>
A-DF(ZN)2Y	36	Multimode G62.5/125	OM1	12	9,5	2700	95,0	4,00	400	85,0	<b>80913</b>
A-DF(ZN)2Y	36	Single-mode E9/125	ITU-T G.652	12	9,5	2700	95,0	4,00	400	85,0	<b>80914</b>
A-DF(ZN)2Y	48	Multimode G50/125	OM2	12	9,5	2700	95,0	4,00	400	85,0	<b>80026</b>
A-DF(ZN)2Y	48	Multimode G62.5/125	OM1	12	9,5	2700	95,0	4,00	400	85,0	<b>80046</b>
A-DF(ZN)2Y	48	Single-mode E9/125	ITU-T G.652	12	9,5	2700	95,0	4,00	400	85,0	<b>80010</b>
A-DF(ZN)2Y	60	Multimode G50/125	OM2	12	9,5	2700	95,0	4,00	400	85,0	<b>80027</b>
A-DF(ZN)2Y	60	Multimode G62.5/125	OM1	12	9,5	2700	95,0	4,00	400	85,0	<b>80047</b>
A-DF(ZN)2Y	60	Single-mode E9/125	ITU-T G.652	12	9,5	2700	95,0	4,00	400	85,0	<b>80011</b>
A-DF(ZN)2Y	72	Multimode G50/125	OM2	12	10,0	2700	100,0	3,80	400	90,0	<b>80473</b>
A-DF(ZN)2Y	72	Multimode G62.5/125	OM1	12	10,0	2700	100,0	3,80	400	90,0	<b>80474</b>
A-DF(ZN)2Y	72	Single-mode E9/125	ITU-T G.652	12	10,0	2700	100,0	3,80	400	90,0	<b>80475</b>
A-DF(ZN)2Y	84	Multimode G50/125	OM2	12	10,7	3000	107,0	4,30	400	120,0	<b>80028</b>
A-DF(ZN)2Y	84	Multimode G62.5/125	OM1	12	10,7	3000	107,0	4,30	400	120,0	<b>80048</b>
A-DF(ZN)2Y	84	Single-mode E9/125	ITU-T G.652	12	10,7	3000	107,0	4,30	400	120,0	<b>80012</b>
A-DF(ZN)2Y	96	Multimode G50/125	OM2	12	11,5	3000	115,0	5,00	400	135,0	<b>80777</b>
A-DF(ZN)2Y	96	Multimode G62.5/125	OM1	12	11,5	3000	115,0	5,00	400	135,0	<b>80774</b>
A-DF(ZN)2Y	96	Single-mode E9/125	ITU-T G.652	12	11,5	3000	115,0	5,00	400	135,0	<b>80764</b>
A-DF(ZN)2Y	144	Multimode G50/125	OM2	12	14,5	3000	145,0	7,70	400	175,0	<b>80032</b>
A-DF(ZN)2Y	144	Multimode G62.5/125	OM1	12	14,5	3000	145,0	7,70	400	175,0	<b>80051</b>
A-DF(ZN)2Y	144	Single-mode E9/125	ITU-T G.652	12	14,5	3000	145,0	7,70	400	175,0	<b>80015</b>

Dimensions and specifications may be changed without prior notice.

## Application

These HELUCOM® fibre-optic cables are characterized by a stranded construction with jelly filling. They are made waterproof in longitudinal direction by filling a jelly mass into the stranding cavities. Non-metallic tension elements ensure above average strain relief. This construction is particularly used in the area of telecommunication and long distance, but also in regular channels and tubes.

# Fibre Optic Outdoor Cable

acc. DIN VDE 0888

**HELUCOM**<sup>®</sup>

A-DF(ZN)B2Y



## Cable structure

Core type: Loose tube  
GRP support element  
Strain relief elements: Aramide  
Type of armouring: Glass yarns  
Outer sheath material: PE  
Outer sheath colour: Black

## Temperature range

Laying, min.: -5°C  
Laying, max.: +50°C  
Operating, min.: -20°C  
Operating, max.: +60°C

## Other data

Corrosiveness acc. to EN50267-2-3  
Halogen-free acc. to 60754-2  
Longitudinally water-tight acc. to IEC 60794-1-2-F5  
UV-resistant

Designation	No. of fibres	Fibre type	Fibre category	Number of fibres per core	Outer Ø app. mm	Max. tensile force N	Min. stat. bending radius mm	Caloric load app. MJ / m	Max. transverse pressure N / cm	Weight kg / km	Part no.
A-DF(ZN)B2Y	2	Multimode G50/125	OM2	2	10,5	2700	105,0	4,40	400	90,0	<b>80100</b>
A-DF(ZN)B2Y	2	Multimode G62.5/125	OM1	2	10,5	2700	105,0	4,40	400	90,0	<b>80115</b>
A-DF(ZN)B2Y	2	Single-mode E9/125	ITU-T G.652	2	10,5	2700	105,0	4,40	400	90,0	<b>80084</b>
A-DF(ZN)B2Y	4	Multimode G50/125	OM2	4	10,5	2700	105,0	4,40	400	90,0	<b>80101</b>
A-DF(ZN)B2Y	4	Multimode G62.5/125	OM1	4	10,5	2700	105,0	4,40	400	90,0	<b>80116</b>
A-DF(ZN)B2Y	4	Single-mode E9/125	ITU-T G.652	4	10,5	2700	105,0	4,40	400	90,0	<b>80085</b>
A-DF(ZN)B2Y	8	Multimode G50/125	OM2	8	10,5	2700	105,0	4,40	400	90,0	<b>80031</b>
A-DF(ZN)B2Y	8	Multimode G62.5/125	OM1	8	10,5	2700	105,0	4,40	400	90,0	<b>80771</b>
A-DF(ZN)B2Y	8	Single-mode E9/125	ITU-T G.652	8	10,5	2700	105,0	4,40	400	90,0	<b>80087</b>
A-DF(ZN)B2Y	12	Multimode G50/125	OM2	12	10,5	2700	105,0	4,40	400	90,0	<b>80104</b>
A-DF(ZN)B2Y	12	Multimode G62.5/125	OM1	12	10,5	2700	105,0	4,40	400	90,0	<b>80120</b>
A-DF(ZN)B2Y	12	Single-mode E9/125	ITU-T G.652	12	10,5	2700	105,0	4,40	400	90,0	<b>80089</b>
A-DF(ZN)B2Y	24	Multimode G50/125	OM2	12	10,5	2700	105,0	4,40	400	90,0	<b>80759</b>
A-DF(ZN)B2Y	24	Multimode G62.5/125	OM1	12	10,5	2700	105,0	4,40	400	90,0	<b>80123</b>
A-DF(ZN)B2Y	24	Single-mode E9/125	ITU-T G.652	12	10,5	2700	105,0	4,40	400	90,0	<b>80092</b>
A-DF(ZN)B2Y	36	Multimode G50/125	OM2	12	10,5	2700	105,0	4,30	400	90,0	<b>81137</b>
A-DF(ZN)B2Y	36	Multimode G62.5/125	OM1	12	10,5	2700	105,0	4,30	400	90,0	<b>81138</b>
A-DF(ZN)B2Y	36	Single-mode E9/125	ITU-T G.652	12	10,5	2700	105,0	4,30	400	90,0	<b>81139</b>
A-DF(ZN)B2Y	48	Multimode G50/125	OM2	12	10,5	2700	105,0	4,20	400	90,0	<b>80109</b>
A-DF(ZN)B2Y	48	Multimode G62.5/125	OM1	12	10,5	2700	105,0	4,20	400	90,0	<b>80125</b>
A-DF(ZN)B2Y	48	Single-mode E9/125	ITU-T G.652	12	10,5	2700	105,0	4,20	400	90,0	<b>80094</b>
A-DF(ZN)B2Y	60	Multimode G50/125	OM2	12	10,5	2700	105,0	4,20	400	90,0	<b>80110</b>
A-DF(ZN)B2Y	60	Multimode G62.5/125	OM1	12	10,5	2700	105,0	4,20	400	90,0	<b>80126</b>
A-DF(ZN)B2Y	60	Single-mode E9/125	ITU-T G.652	12	10,5	2700	105,0	4,20	400	90,0	<b>80095</b>
A-DF(ZN)B2Y	72	Multimode G50/125	OM2	12	11,0	2700	110,0	4,10	400	95,0	<b>81143</b>
A-DF(ZN)B2Y	72	Multimode G62.5/125	OM1	12	11,0	2700	110,0	4,10	400	95,0	<b>81144</b>
A-DF(ZN)B2Y	72	Single-mode E9/125	ITU-T G.652	12	11,0	2700	110,0	4,10	400	95,0	<b>81145</b>
A-DF(ZN)B2Y	84	Multimode G50/125	OM2	12	11,5	3000	115,0	4,60	400	136,0	<b>80111</b>
A-DF(ZN)B2Y	84	Multimode G62.5/125	OM1	12	11,5	3000	115,0	4,60	400	136,0	<b>80127</b>
A-DF(ZN)B2Y	84	Single-mode E9/125	ITU-T G.652	12	11,5	3000	115,0	4,60	400	136,0	<b>80096</b>
A-DF(ZN)B2Y	96	Multimode G50/125	OM2	12	12,0	3000	120,0	5,30	400	155,0	<b>81147</b>
A-DF(ZN)B2Y	96	Multimode G62.5/125	OM1	12	12,0	3000	120,0	5,30	400	155,0	<b>81148</b>
A-DF(ZN)B2Y	96	Single-mode E9/125	ITU-T G.652	12	12,0	3000	120,0	5,30	400	155,0	<b>81149</b>
A-DF(ZN)B2Y	144	Multimode G50/125	OM2	12	14,5	3000	145,0	8,00	400	228,0	<b>80114</b>
A-DF(ZN)B2Y	144	Multimode G62.5/125	OM1	12	14,5	3000	145,0	8,00	400	228,0	<b>80130</b>
A-DF(ZN)B2Y	144	Single-mode E9/125	ITU-T G.652	12	14,5	3000	145,0	8,00	400	228,0	<b>80099</b>

Dimensions and specifications may be changed without prior notice.

## Application

These HELUCOM<sup>®</sup> fibre-optic cables are characterized by a stranded construction with jelly filling. They are made waterproof in longitudinal direction by filling a jelly mass into the stranding cavities. Non-metallic tension elements and glass yarns ensure above average strain relief and rodent protection. This construction is particularly used in the area of telecommunication and long distance, but also in regular channels and tubes where rodent infestation is possible.

# Fibre Optic Outdoor Cable

acc. DIN VDE 0888

**HELUCOM®**

A-DF(ZN)2Y4Y



## Cable structure

Core type: Loose tube  
GRP support element  
Strain relief elements: Aramide  
Inner sheath material: PE  
Type of armouring: PA sheath  
Outer sheath material: PA  
Outer sheath colour: Black

## Temperature range

Laying, min.: -5°C  
Laying, max.: +50°C  
Operating, min.: -20°C  
Operating, max.: +60°C

## Other data

Corrosiveness acc. to EN50267-2-3  
Halogen-free acc. to 60754-2  
Longitudinally water-tight acc. to IEC 60794-1-2-F5  
Cable, laterally water-tight  
UV-resistant

Designation	No. of fibres	Fibre type	Fibre category	Number of fibres per core	Outer Ø app. mm	Max. tensile force N	Min. stat. bending radius mm	Caloric load app. MJ / m	Max. transverse pressure N / cm	Weight kg / km	Part no.
A-DF(ZN)2Y4Y	2	Multimode G50/125	OM2	2	10,0	2700	100,0	6,10	400	90,0	<b>80915</b>
A-DF(ZN)2Y4Y	2	Multimode G62.5/125	OM1	2	10,0	2700	100,0	6,10	400	90,0	<b>80927</b>
A-DF(ZN)2Y4Y	2	Single-mode E9/125	ITU-T G.652	2	10,0	2700	100,0	6,10	400	90,0	<b>80945</b>
A-DF(ZN)2Y4Y	4	Multimode G50/125	OM2	4	10,0	2700	100,0	6,10	400	90,0	<b>80735</b>
A-DF(ZN)2Y4Y	4	Multimode G62.5/125	OM1	4	10,0	2700	100,0	6,10	400	90,0	<b>80928</b>
A-DF(ZN)2Y4Y	4	Single-mode E9/125	ITU-T G.652	4	10,0	2700	100,0	6,10	400	90,0	<b>80895</b>
A-DF(ZN)2Y4Y	8	Multimode G50/125	OM2	8	10,0	2700	100,0	6,10	400	90,0	<b>80691</b>
A-DF(ZN)2Y4Y	8	Multimode G62.5/125	OM1	8	10,0	2700	100,0	6,10	400	90,0	<b>80809</b>
A-DF(ZN)2Y4Y	8	Single-mode E9/125	ITU-T G.652	8	10,0	2700	100,0	6,10	400	90,0	<b>80118</b>
A-DF(ZN)2Y4Y	12	Multimode G50/125	OM2	12	10,0	2700	100,0	6,10	400	90,0	<b>80627</b>
A-DF(ZN)2Y4Y	12	Multimode G62.5/125	OM1	12	10,0	2700	100,0	6,10	400	90,0	<b>80931</b>
A-DF(ZN)2Y4Y	12	Single-mode E9/125	ITU-T G.652	12	10,0	2700	100,0	6,10	400	90,0	<b>80947</b>
A-DF(ZN)2Y4Y	24	Multimode G50/125	OM2	12	10,0	2700	100,0	6,10	400	90,0	<b>80578</b>
A-DF(ZN)2Y4Y	24	Multimode G62.5/125	OM1	12	10,0	2700	100,0	6,10	400	90,0	<b>80576</b>
A-DF(ZN)2Y4Y	24	Single-mode E9/125	ITU-T G.652	12	10,0	2700	100,0	6,10	400	90,0	<b>80577</b>
A-DF(ZN)2Y4Y	36	Multimode G50/125	OM2	12	10,0	2700	100,0	6,00	400	90,0	<b>80672</b>
A-DF(ZN)2Y4Y	36	Multimode G62.5/125	OM1	12	10,0	2700	100,0	6,00	400	90,0	<b>80935</b>
A-DF(ZN)2Y4Y	36	Single-mode E9/125	ITU-T G.652	12	10,0	2700	100,0	6,00	400	90,0	<b>80950</b>
A-DF(ZN)2Y4Y	48	Multimode G50/125	OM2	12	10,0	2700	100,0	6,00	400	90,0	<b>80732</b>
A-DF(ZN)2Y4Y	48	Multimode G62.5/125	OM1	12	10,0	2700	100,0	6,00	400	90,0	<b>80936</b>
A-DF(ZN)2Y4Y	48	Single-mode E9/125	ITU-T G.652	12	10,0	2700	100,0	6,00	400	90,0	<b>80951</b>
A-DF(ZN)2Y4Y	60	Multimode G50/125	OM2	12	10,0	2700	100,0	5,80	400	90,0	<b>80920</b>
A-DF(ZN)2Y4Y	60	Multimode G62.5/125	OM1	12	10,0	2700	100,0	5,80	400	90,0	<b>80938</b>
A-DF(ZN)2Y4Y	72	Multimode G50/125	OM2	12	10,5	2700	105,0	5,80	400	95,0	<b>80921</b>
A-DF(ZN)2Y4Y	72	Multimode G62.5/125	OM1	12	10,5	2700	105,0	5,80	400	95,0	<b>80939</b>
A-DF(ZN)2Y4Y	72	Single-mode E9/125	ITU-T G.652	12	10,5	2700	105,0	5,80	400	95,0	<b>80954</b>
A-DF(ZN)2Y4Y	84	Multimode G50/125	OM2	12	11,0	3000	110,0	8,40	400	110,0	<b>80922</b>
A-DF(ZN)2Y4Y	84	Multimode G62.5/125	OM1	12	11,0	3000	110,0	8,40	400	110,0	<b>80940</b>
A-DF(ZN)2Y4Y	84	Single-mode E9/125	ITU-T G.652	12	11,0	3000	110,0	8,40	400	110,0	<b>80955</b>
A-DF(ZN)2Y4Y	96	Multimode G50/125	OM2	12	11,5	3000	115,0	7,20	400	120,0	<b>80923</b>
A-DF(ZN)2Y4Y	96	Multimode G62.5/125	OM1	12	11,5	3000	115,0	7,20	400	120,0	<b>80941</b>
A-DF(ZN)2Y4Y	96	Single-mode E9/125	ITU-T G.652	12	11,5	3000	115,0	7,20	400	120,0	<b>80956</b>
A-DF(ZN)2Y4Y	144	Multimode G50/125	OM2	12	14,5	3000	145,0	10,40	400	180,0	<b>80926</b>
A-DF(ZN)2Y4Y	144	Multimode G62.5/125	OM1	12	14,5	3000	145,0	10,40	400	180,0	<b>80944</b>
A-DF(ZN)2Y4Y	144	Single-mode E9/125	ITU-T G.652	12	14,5	3000	145,0	10,40	400	180,0	<b>80959</b>

Dimensions and specifications may be changed without prior notice.

## Application

These HELUCOM® fibre-optic cables are characterized by a stranded construction with jelly filling. They are made waterproof in longitudinal direction by filling a jelly mass into the stranding cavities. Non-metallic tension elements and a second outer sheath made of polyamide (PA) ensure above average strain relief and rodent protection. This construction is particularly used in the area of telecommunication and long distance, but also in regular channels and tubes where rodent infestation is possible.

# Fibre Optic Outdoor Cable

Microduct

HELUCOM®

A-DQ2Y, central



## Cable structure

Core type: Loose tube  
Strain relief elements: Aramide  
Outer sheath material: PE  
Outer sheath colour: Black

## Temperature range

Laying, min.: -20°C  
Laying, max.: +60°C  
Operating, min.: -20°C  
Operating, max.: +60°C

## Other data

Corrosiveness acc. to EN50267-2-3  
Halogen-free acc. to 60754-2  
Longitudinally water-tight acc. to IEC 60794-1-2-F5  
UV-resistant

Designation	No. of fibres	Fibre type	Fibre category	Number of fibres per core	Outer Ø app. mm	Max. tensile force N	Min. stat. bending radius mm	Caloric load app. MJ / m	Max. transverse pressure N / cm	Weight kg / km	Part no.
A-DQ2Y central	4	Single-mode E9/125	ITU-T G.652	4	2,5	180	40,0	1,40	100	6,0	<b>803664</b>
A-DQ2Y central	4	Single-mode E9/125	ITU-T G.657	4	2,5	180	40,0	1,40	100	6,0	<b>805672</b>
A-DQ2Y central	12	Single-mode E9/125	ITU-T G.652	12	2,5	180	40,0	1,40	100	6,0	<b>803929</b>
A-DQ2Y central	12	Single-mode E9/125	ITU-T G.657	12	2,5	180	40,0	1,40	100	6,0	<b>805673</b>

Dimensions and specifications may be changed without prior notice.

## Application

These HELUCOM® micro fibre-optic cables are characterized by a design that is slim but robust. Around a central tube, there is a composite of swelling fleece with characteristics that ensure the strain relief, and waterproofing in longitudinal direction of the cable. Another feature is the low adhesion of the outer jacket. Therefore these cables can be blowing into microducts. A typical application is FTTH within communal building projects.



# Fibre Optic Outdoor Cable

Microduct

**HELUCOM®**

A-DQ2Y, stranded



## Cable structure

Core type: Loose tube  
Strain relief elements: Aramide  
Outer sheath material: PE  
Outer sheath colour: Black

## Temperature range

Laying, min.: -5°C  
Laying, max.: +50°C  
Operating, min.: -30°C  
Operating, max.: +70°C

## Other data

Corrosiveness acc. to EN50267-2-3  
Halogen-free acc. to 60754-2  
Longitudinally water-tight acc. to IEC 60794-1-2-F5  
UV-resistant

Designation	No. of fibres	Fibre type	Fibre category	Number of fibres per core	Outer Ø app. mm	Max. tensile force N	Min. stat. bending radius mm	Caloric load app. MJ / m	Max. transverse pressure N / cm	Weight kg / km	Part no.
A-DQ2Y stranded	4	Single-mode E9/125	ITU-T G.652	4	5,8	850	90,0	0,87	150	27,0	<b>803931</b>
A-DQ2Y stranded	4	Single-mode E9/125	ITU-T G.657	4	5,8	850	90,0	0,87	150	27,0	<b>805664</b>
A-DQ2Y stranded	12	Single-mode E9/125	ITU-T G.652	12	5,8	850	90,0	0,87	150	27,0	<b>803932</b>
A-DQ2Y stranded	12	Single-mode E9/125	ITU-T G.657	12	5,8	850	90,0	0,87	150	27,0	<b>805665</b>
A-DQ2Y stranded	24	Single-mode E9/125	ITU-T G.652	12	5,8	850	90,0	0,87	150	27,0	<b>803930</b>
A-DQ2Y stranded	24	Single-mode E9/125	ITU-T G.657	12	5,8	850	90,0	0,87	150	27,0	<b>805666</b>
A-DQ2Y stranded	48	Single-mode E9/125	ITU-T G.652	12	5,8	850	90,0	0,87	150	27,0	<b>803658</b>
A-DQ2Y stranded	48	Single-mode E9/125	ITU-T G.657	12	5,8	850	90,0	0,87	150	27,0	<b>805667</b>
A-DQ2Y stranded	72	Single-mode E9/125	ITU-T G.652	12	5,8	850	90,0	0,87	150	27,0	<b>803659</b>
A-DQ2Y stranded	72	Single-mode E9/125	ITU-T G.657	12	5,8	850	90,0	0,87	150	27,0	<b>805668</b>
A-DQ2Y stranded	96	Single-mode E9/125	ITU-T G.652	12	6,8	1500	105,0	1,25	150	45,0	<b>803660</b>
A-DQ2Y stranded	96	Single-mode E9/125	ITU-T G.657	12	6,8	1500	105,0	1,25	150	45,0	<b>805669</b>
A-DQ2Y stranded	144	Single-mode E9/125	ITU-T G.652	12	9,4	1500	140,0	2,19	150	79,0	<b>803661</b>
A-DQ2Y stranded	144	Single-mode E9/125	ITU-T G.657	12	9,4	1500	140,0	2,19	150	79,0	<b>805670</b>
A-DQ2Y stranded	288	Single-mode E9/125	ITU-T G.652	12	10,2	3000	160,0	2,97	100	90,0	<b>803668</b>
A-DQ2Y stranded	288	Single-mode E9/125	ITU-T G.652	24	9,4	2500	150,0	2,97	150	77,0	<b>805674</b>
A-DQ2Y stranded	288	Single-mode E9/125	ITU-T G.657	12	10,2	3000	160,0	2,97	100	90,0	<b>805671</b>
A-DQ2Y stranded	288	Single-mode E9/125	ITU-T G.657	24	9,4	2500	150,0	2,97	150	77,0	<b>805675</b>

Dimensions and specifications may be changed without prior notice.

## Application

These HELUCOM® micro fibre-optic cables are characterized by a design that is slim but robust. Around stranded tubes, there is a composite of swelling material with characteristics that ensure the strain relief, and waterproofing in longitudinal direction of the cable. Another feature of these cables is the low adhesion of the outer jacket. Therefore these cables can be blowing into microducts. A typical application is FTTx within communal infrastructure projects.

# Fibre Optic Outdoor Cable

steel armoured

HELUCOM®

A-DQ(ZN)(SR)2Y



## Cable structure

Core type: Loose tube  
Strain relief elements: Glass yarns  
Type of armouring: Steel rib  
Outer sheath material: PE  
Outer sheath colour: Black

## Temperature range

Laying, min.: -5°C  
Laying, max.: +50°C  
Operating, min.: -20°C  
Operating, max.: +70°C

## Other data

Corrosiveness acc. to EN50267-2-3  
Halogen-free acc. to 60754-2  
Longitudinally water-tight acc. to IEC 60794-1-2-F5  
Cable, laterally water-tight  
UV-resistant

Designation	No. of fibres	Fibre type	Fibre category	Number of fibres per core	Outer Ø app. mm	Max. tensile force N	Min. stat. bending radius mm	Caloric load app. MJ / m	Max. transverse pressure N / cm	Weight kg / km	Part no.
A-DQ(ZN)(SR)2Y	4	Multimode G50/125	OM2	4	9,5	1500	95,0	2,00	500	115,0	<b>802917</b>
A-DQ(ZN)(SR)2Y	4	Multimode G62.5/125	OM1	4	9,5	1500	95,0	2,00	500	115,0	<b>803925</b>
A-DQ(ZN)(SR)2Y	4	Single-mode E9/125	ITU-T G.652	4	9,5	1500	95,0	2,00	500	105,0	<b>803927</b>
A-DQ(ZN)(SR)2Y	12	Multimode G50/125	OM2	12	9,5	1500	95,0	2,00	500	115,0	<b>802918</b>
A-DQ(ZN)(SR)2Y	12	Multimode G62.5/125	OM1	12	9,5	1500	95,0	2,00	500	115,0	<b>803926</b>
A-DQ(ZN)(SR)2Y	12	Single-mode E9/125	ITU-T G.652	12	9,5	1500	95,0	2,00	500	115,0	<b>803928</b>
A-DQ(ZN)(SR)2Y	24	Single-mode E9/125	ITU-T G.652	24	9,5	1500	95,0	2,00	500	115,0	<b>804797</b>

Dimensions and specifications may be changed without prior notice.

## Application

These HELUCOM® fibre-optic cables are characterized by a compact construction with a swelling fleece. Above-average rodent protection is achieved with the metallic rodent protection (steel groove) and an outer sheath made of PE. This construction is particularly used in the area of telecommunication and long distance, but also in regular channels and tubes where rodent infestation is possible.

# Fibre Optic Outdoor Cable

steel armoured

**HELUCOM®**

A-DF(ZN)2Y(SR)2Y



**NEW**

## Cable structure

Core type: Loose tube  
 GRP support element  
 Strain relief elements: Aramide  
 Inner sheath material: PE  
 Type of armoring: Steel rib  
 Outer sheath material: PE  
 Outer sheath colour: Black

## Temperature range

Laying, min.: -20°C  
 Laying, max.: +50°C  
 Operating, min.: -30°C  
 Operating, max.: +70°C

## Other data

Corrosiveness acc. to EN50267-2-3  
 Halogen-free acc. to 60754-2  
 Longitudinally water-tight acc. to IEC 60794-1-2-F5  
 Cable, laterally water-tight  
 UV-resistant

Designation	No. of fibres	Fibre type	Fibre category	Number of fibres per core	Outer Ø app. mm	Max. tensile force N	Min. stat. bending radius mm	Caloric load app. MJ / m	Max. transverse pressure N / cm	Weight kg / km	Part no.
A-DF(ZN)2Y(SR)2Y 12	12	Single-mode E9/125	ITU-T G.652	2	13,0	2500	200,0	4,30	400	160,0	<b>805244</b>
A-DF(ZN)2Y(SR)2Y 24	24	Single-mode E9/125	ITU-T G.652	4	13,0	2500	200,0	4,30	400	160,0	<b>805245</b>
A-DF(ZN)2Y(SR)2Y 48	48	Single-mode E9/125	ITU-T G.652	12	13,5	2500	210,0	4,50	400	170,0	<b>805246</b>
A-DF(ZN)2Y(SR)2Y 60	60	Single-mode E9/125	ITU-T G.652	12	13,5	2500	210,0	4,50	400	170,0	<b>805247</b>

Dimensions and specifications may be changed without prior notice.

## Application

These HELUCOM® fibre-optic cables are characterized by a stranded construction with jelly filling. They are made waterproof in longitudinal direction by filling a jelly mass into the stranding cavities. Above-average rodent protection is achieved with the metallic rodent protection (corrugated steel) and the second outer sheath made of PE. This construction is particularly used in the area of telecommunication and long distance, but also in regular channels and tubes where rodent infestation is possible.

# Fibre Optic Outdoor Cable

acc. ARCOR Standard

**HELUCOM**<sup>®</sup>

A-DF(ZN)2Y(SR)2Y

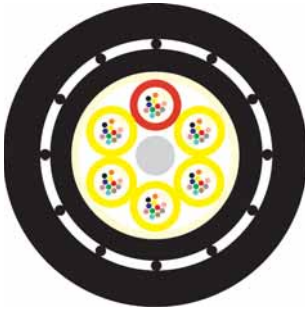

## Cable structure

Core type: Loose tube  
 GRP support element  
 Strain relief elements: Aramide  
 Inner sheath material: PE  
 Type of armouring: Steel rib  
 Outer sheath material: PE  
 Outer sheath colour: Black

## Temperature range

Laying, min.: -20°C  
 Laying, max.: +50°C  
 Operating, min.: -30°C  
 Operating, max.: +70°C

## Other data

Corrosiveness acc. to EN50267-2-3  
 Halogen-free acc. to 60754-2  
 Longitudinally water-tight acc. to IEC 60794-1-2-F5  
 Cable, laterally water-tight  
 UV-resistant

Designation	No. of fibres	Fibre type	Fibre category	Number of fibres per core	Outer Ø app. mm	Max. tensile force N	Min. stat. bending radius mm	Caloric load app. MJ / m	Max. transverse pressure N / cm	Weight kg / km	Part no.
A-DF(ZN)2Y(SR)2Y 12	12	Single-mode E9/125	ITU-T G.652	2	15,0	2700	230,0	4,80	400	215,0	<b>82190</b>
A-DF(ZN)2Y(SR)2Y 24	24	Single-mode E9/125	ITU-T G.652	4	15,0	2700	230,0	4,80	400	215,0	<b>800708</b>
A-DF(ZN)2Y(SR)2Y 48	48	Single-mode E9/125	ITU-T G.652	12	17,0	2700	260,0	6,00	400	260,0	<b>800709</b>
A-DF(ZN)2Y(SR)2Y 60	60	Single-mode E9/125	ITU-T G.652	12	17,0	2700	260,0	6,00	400	260,0	<b>800710</b>
A-DF(ZN)2Y(SR)2Y 144	144	Single-mode E9/125	ITU-T G.652	12	23,0	3500	350,0	10,10	400	480,0	<b>803284</b>

Dimensions and specifications may be changed without prior notice.

## Application

These HELUCOM<sup>®</sup> fibre-optic cables are characterized by a stranded construction with jelly filling. They are made waterproof in longitudinal direction by filling a jelly mass into the stranding cavities. Above-average rodent protection is achieved with the metallic rodent protection (steel groove) and the second outer sheath made of PE. This construction is particularly used in the area of telecommunication and long distance where ARCOR standards must be followed, but also in regular channels and tubes where rodent infestation is possible.

# Fibre Optic Outdoor Cable Hybrid

acc. DIN VDE 0888

HELUCOM®

A-DSQ(ZN)B2Y



## Cable structure

Core type: Loose tube  
GRP support element  
Number of fibres per core: 4  
Strain relief elements: Glass yarns  
Type of armouring: Glass yarns  
Outer sheath material: PE  
Outer sheath colour: Black

## Temperature range

Laying, min.: -10°C  
Laying, max.: +60°C  
Operating, min.: -25°C  
Operating, max.: +60°C

## Other data

Corrosiveness acc. to EN50267-2-3  
Longitudinally water-tight acc. to IEC 60794-1-2-F5  
UV-resistant

Designation	No. of fibres	Fibre type	No. of copper cores	Dimensions of copper cores mm	Outer Ø app. mm	Max. tensile force N	Min. stat. bending radius mm	Caloric load app. MJ / m	Max. transverse pressure N / cm	Weight kg / km	Part no.
A-DSQ(ZN)B2Y	4	Multimode G50/125	2	1,2	12,0	2100	300	4,80	200	140,0	<b>81209</b>
A-DSQ(ZN)B2Y	4	Multimode G62.5/125	2	1,2	12,0	2100	300	4,80	200	140,0	<b>81255</b>
A-DSQ(ZN)B2Y	4	Single-mode E9/125	2	1,2	12,0	2100	300	4,80	200	140,0	<b>81256</b>
A-DSQ(ZN)B2Y	4	Multimode G50/125	2	1,5	12,5	2300	320	4,80	200	160,0	<b>82561</b>
A-DSQ(ZN)B2Y	4	Multimode G62.5/125	2	1,5	12,5	2300	320	4,80	200	160,0	<b>81257</b>
A-DSQ(ZN)B2Y	4	Single-mode E9/125	2	1,5	12,5	2300	320	4,80	200	160,0	<b>81258</b>
A-DSQ(ZN)B2Y	4	Multimode G50/125	4	1,5	17,0	2600	430	5,80	200	250,0	<b>82786</b>
A-DSQ(ZN)B2Y	4	Multimode G62.5/125	4	1,5	17,0	2600	430	5,80	200	250,0	<b>81259</b>
A-DSQ(ZN)B2Y	4	Single-mode E9/125	4	1,5	17,0	2600	430	5,80	200	250,0	<b>81260</b>

Dimensions and specifications may be changed without prior notice.

## Application

These HELUCOM® fibre-optic cables are designed especially for use in fibre-optical temperature measurements, such as monitoring of dams. The extreme mechanical requirements in these areas are fulfilled by the specially designed cable construction. These lines are hybrid glass fibre lines with copper cores and a special PE outer sheath.

Typical application within a coffer-dam



# Fibre Optic Outdoor Cable Hybrid

acc. DIN VDE 0888

HELUCOM®

A-DSF(L)(ZN)2Y

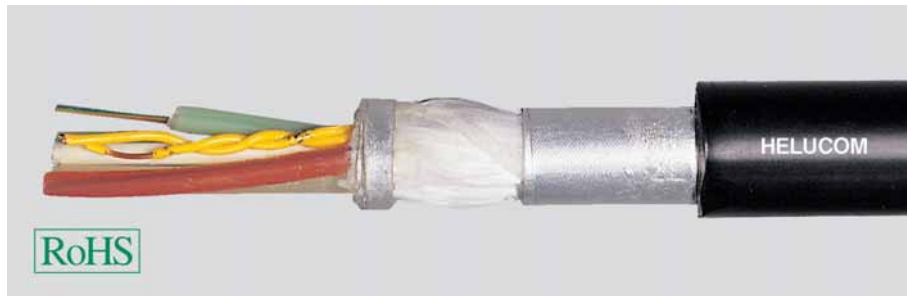

## Cable structure

Core type: Loose tube  
GRP support element  
Number of fibres per core: 12  
Strain relief elements: Aramide  
Aluminium laminated sheath  
Outer sheath material: PE  
Outer sheath colour: Black

## Temperature range

Laying, min.: -5°C  
Laying, max.: +50°C  
Operating, min.: -25°C  
Operating, max.: +60°C

## Other data

Corrosiveness acc. to EN50267-2-3  
Halogen-free acc. to 60754-2  
Longitudinally water-tight acc. to IEC 60794-1-2-F5  
Cable, laterally water-tight  
UV-resistant

Designation	No. of fibres	Fibre type	No. of copper cores	Dimensions of copper cores mm	Outer Ø app. mm	Max. tensile force N	Min. stat. bending radius mm	Caloric load app. MJ / m	Max. transverse pressure N / cm	Weight kg / km	Part no.
A-DSF(L)(ZN)2Y	12	Single-mode E9/125	2	0,6	12,0	2500	200	4,80	250	135,0	<b>80495</b>
A-DSF(L)(ZN)2Y	12	Single-mode E9/125	4	0,6	12,0	2500	200	4,80	250	140,0	<b>80497</b>
A-DSF(L)(ZN)2Y	24	Single-mode E9/125	2	0,6	13,1	2500	200	4,80	250	139,0	<b>800753</b>
A-DSF(L)(ZN)2Y	24	Single-mode E9/125	4	0,6	13,1	2500	200	4,80	250	144,0	<b>801182</b>
A-DSF(L)(ZN)2Y	48	Single-mode E9/125	2	0,6	13,1	2500	200	4,80	250	141,0	<b>80501</b>
A-DSF(L)(ZN)2Y	48	Single-mode E9/125	4	0,6	13,1	2500	200	4,80	250	146,0	<b>80503</b>
A-DSF(L)(ZN)2Y	60	Single-mode E9/125	2	0,6	14,1	2500	230	4,80	250	166,0	<b>80504</b>
A-DSF(L)(ZN)2Y	60	Single-mode E9/125	4	0,6	14,1	2500	230	4,80	250	171,0	<b>80506</b>
A-DSF(L)(ZN)2Y	72	Single-mode E9/125	2	0,6	14,8	2500	240	5,10	250	179,0	<b>80507</b>
A-DSF(L)(ZN)2Y	72	Single-mode E9/125	4	0,6	14,8	2500	240	5,10	250	184,0	<b>80509</b>
A-DSF(L)(ZN)2Y	96	Single-mode E9/125	2	0,6	16,6	3000	280	6,30	250	276,0	<b>80510</b>
A-DSF(L)(ZN)2Y	96	Single-mode E9/125	4	0,6	16,6	3000	280	6,30	250	281,0	<b>80512</b>
A-DSF(L)(ZN)2Y	120	Single-mode E9/125	2	0,6	18,4	3000	290	8,50	250	280,0	<b>80513</b>
A-DSF(L)(ZN)2Y	120	Single-mode E9/125	4	0,6	18,4	3000	290	8,50	250	285,0	<b>80515</b>
A-DSF(L)(ZN)2Y	144	Single-mode E9/125	2	0,6	20,3	3500	310	10,00	250	331,0	<b>80516</b>
A-DSF(L)(ZN)2Y	144	Single-mode E9/125	4	0,6	20,3	3500	310	10,00	250	336,0	<b>80518</b>

Dimensions and specifications may be changed without prior notice.

## Application

These HELUCOM® outdoor cables are designed for use under extreme environmental conditions. With the double jelly filling and the Al/PE laminated sheath, they are waterproof in longitudinal and transverse direction. The welded Al tape acts as an additional vapour barrier. These cables can be laid directly in the ground, in tubes and in ducts. They are mainly used in local and long-distance networks.

# Aerial Fibre Optic Cable

metall free

HELUCOM®

ADSS L



## Cable structure

Core type: Loose tube  
 GRP support element  
 Strain relief elements: Aramide  
 Inner sheath material: PE  
 Outer sheath material: PE  
 Outer sheath colour: Black

## Temperature range

Laying, min.: -10°C  
 Laying, max.: +60°C  
 Operating, min.: -40°C  
 Operating, max.: +70°C

## Other data

Sag at 25°C ADSS 6L: 1,0m  
 Sag at 25°C ADSS 9L: 1,6m  
 Sag at 25°C ADSS 16L: 3,6m  
 Halogen-free acc. to 60754-2  
 Longitudinally water-tight acc. to IEC 60794-1-2-F5  
 Cable, laterally water-tight  
 UV-resistant

Designation	Number of fibres	Fibre type	Number of fibres per core	Span width m	Max. tensile force kN	Additional load daN / m	Min. stat. bending radius mm	Outer Ø app. mm	Weight kg / km	Part no.
ADSS 6L	12	Single-mode E9/125	6	80	3	0,073	230	11,5	100	<b>804733</b>
ADSS 6L	24	Single-mode E9/125	6	80	3	0,073	230	11,5	100	<b>805160</b>
ADSS 6L	48	Single-mode E9/125	12	80	3	0,073	252	12,6	120	<b>804735</b>
ADSS 6L	144	Single-mode E9/125	12	80	7	0,073	348	17,4	230	<b>804736</b>
ADSS 9L	12	Single-mode E9/125	6	150	4	0,073	230	11,5	100	<b>804737</b>
ADSS 9L	24	Single-mode E9/125	6	150	4	0,073	230	11,5	100	<b>805161</b>
ADSS 9L	48	Single-mode E9/125	12	150	4	0,073	252	12,6	120	<b>804739</b>
ADSS 9L	144	Single-mode E9/125	12	150	10	0,073	354	17,7	240	<b>804740</b>
ADSS 16L	12	Single-mode E9/125	6	350	11	0,073	250	12,5	120	<b>804741</b>
ADSS 16L	24	Single-mode E9/125	6	350	11	0,073	250	12,5	120	<b>804742</b>
ADSS 16L	48	Single-mode E9/125	12	350	9	0,073	264	13,2	135	<b>804743</b>
ADSS 16L	144	Single-mode E9/125	12	350	16	0,073	362	18,1	250	<b>804744</b>

Dimensions and specifications may be changed without prior notice.

## Application

These HELUCOM® ADSS L cables designed as aerial cables for freely suspended installations on steel-bar-, wood-, concrete- or steel poles. The construction is waterproof in longitudinal direction thanks to the use of jelly-filled bundle cores and swelling tape. The outer jacket is UV-resistant and at the same time provides protection against light and normal environmental influences, such as sun insolation and wind. Installations on high voltage poles are possible up to a field-strength of 4 kV. There are constructions for span width of 80m, 150m or 350m under conditions according NESCE® Light available. Corresponding accessories like suspension and tension fittings are in chapter 5.

# Aerial Fibre Optic Cable

metall free

HELUCOM®

ADSS



## Cable structure

Core type: Loose tube  
GRP support element  
Strain relief elements: Aramide  
Inner sheath material: PE  
Outer sheath material: PE  
Outer sheath colour: Black

## Temperature range

Laying, min.: -10°C  
Laying, max.: +60°C  
Operating, min.: -25°C  
Operating, max.: +70°C

## Other data

Sag at 25°C ADSS 9: 2,0m  
Sag at 25°C ADSS 16: 4,5m  
Sag at 25°C ADSS 35: 9,5m  
Halogen-free acc. to 60754-2  
Longitudinally water-tight acc. to IEC 60794-1-2-F5  
Cable, laterally water-tight  
UV-resistant

Designation	Number of fibres	Fibre type	Number of fibres per core	Span width m	Max. tensile force kN	Additional load daN / m	Min. stat. bending radius mm	Outer Ø app. mm	Weight kg / km	Part no.
ADSS 9	12	Single-mode E9/125	4	150	9	0,5	410	13,6	135	<b>82390</b>
ADSS 9	24	Single-mode E9/125	4	150	9	0,5	410	13,6	137	<b>82391</b>
ADSS 9	36	Single-mode E9/125	6	150	9	0,5	470	15,6	177	<b>82392</b>
ADSS 9	48	Single-mode E9/125	8	150	9	0,5	470	15,6	178	<b>82393</b>
ADSS 9	60	Single-mode E9/125	12	150	9	0,5	450	15,0	161	<b>82394</b>
ADSS 9	96	Single-mode E9/125	12	150	9	0,5	450	15,5	180	<b>804275</b>
ADSS 9	144	Single-mode E9/125	12	150	9	0,5	630	20,8	316	<b>82395</b>
ADSS 16	12	Single-mode E9/125	4	350	16	0,3	430	14,4	162	<b>82396</b>
ADSS 16	24	Single-mode E9/125	4	350	16	0,3	430	14,4	165	<b>82397</b>
ADSS 16	36	Single-mode E9/125	6	350	16	0,3	500	16,4	200	<b>82398</b>
ADSS 16	48	Single-mode E9/125	8	350	16	0,3	500	16,4	201	<b>82399</b>
ADSS 16	60	Single-mode E9/125	12	350	16	0,3	480	15,8	184	<b>82400</b>
ADSS 16	96	Single-mode E9/125	12	350	16	0,3	480	16,0	200	<b>804276</b>
ADSS 16	144	Single-mode E9/125	12	350	16	0,3	650	21,6	333	<b>82401</b>
ADSS 35	12	Single-mode E9/125	4	700	35	0,35	520	17,2	198	<b>82402</b>
ADSS 35	24	Single-mode E9/125	4	700	35	0,35	520	17,2	200	<b>82403</b>
ADSS 35	36	Single-mode E9/125	6	700	35	0,35	580	19,2	240	<b>82404</b>
ADSS 35	48	Single-mode E9/125	8	700	35	0,35	580	19,2	241	<b>82405</b>
ADSS 35	60	Single-mode E9/125	12	700	35	0,35	560	18,6	227	<b>82406</b>
ADSS 35	144	Single-mode E9/125	12	700	35	0,35	730	24,4	381	<b>82407</b>

Dimensions and specifications may be changed without prior notice.

## Application

These HELUCOM® outdoor cables designed as aerial cables for freely suspended installations on posts and masts. The construction is waterproof in longitudinal direction thanks to the use of jelly-filled bundle cores and swelling tape. The outer jacket is UV-resistant and at the same time provides protection against environmental influences, such as snow, ice, sun insolation and wind. Corresponding accessories like suspension and tension fittings are in chapter 5.



# Fibre Optic Cable flexible

WK - mobile

HELUCOM® WK

A-V(ZN)11Y

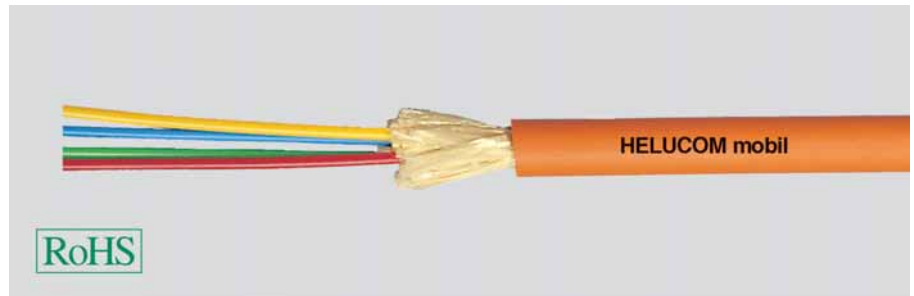

## Cable structure

Core type: Tight buffer  
Strain relief elements: Aramide  
Outer sheath colour: Orange

## Temperature range

Laying, min.: +5°C  
Laying, max.: +50°C  
Operating, min.: -30°C  
Operating, max.: +70°C

## Other data

Max. tensile force: 650 N  
Max. transverse pressure: 40 N / cm  
Longitudinally water-tight acc. to IEC 60794-1-2-F5  
UV-resistant  
Resistant to hammer impact acc. to IEC 60794-1-2-E4  
Bending cycles acc. to IEC 60794-1-2-E6: 500.000  
Oil-resistant

Designation	Number of fibres	Fibre type	Fibre category	Outer Ø app. mm	Outer sheath material	Min. stat. bending radius mm	Flame proof	halogen-free	UL	Weight kg / km	Part no.
Fibre-optic cable	2	Multimode G50/125	OM2	5,0	PUR	75	yes	yes	no	20	<b>80382</b>
Fibre-optic cable	2	Multimode G62.5/125	OM1	5,0	PUR	75	yes	yes	no	20	<b>80363</b>
Fibre-optic cable	4	Multimode G50/125	OM2	5,8	PUR	90	yes	yes	no	31	<b>80534</b>
Fibre-optic cable	4	Multimode G62.5/125	OM1	5,8	PUR	90	yes	yes	no	31	<b>81036</b>
Fibre-optic cable	4	Single-mode E9/125	ITU-T G.652	5,8	PUR	90	yes	yes	no	31	<b>801727</b>
Fibre-optic cable	8	Multimode G50/125	OM2	7,0	PUR	105	yes	yes	no	47	<b>81037</b>
Fibre-optic cable	8	Multimode G62.5/125	OM1	7,0	PUR	105	yes	yes	no	47	<b>81038</b>

Dimensions and specifications may be changed without prior notice.

## Application

These HELUCOM® cables were designed as mobile field cables. They are easily wound up on a drum and are very tension-proof. As the outer sheath is tightly anchored on the aramid braiding, it is especially suitable for mobile use. The advantage of these cables is evident especially where mobile fibre-optic lines are to be installed, such as for Drag Chains, TV transmission, supervision of protected areas, etc.

# Fibre Optic Cable flexible

WK - UL/CSA

HELUCOM® WK

A-V(ZN)YY

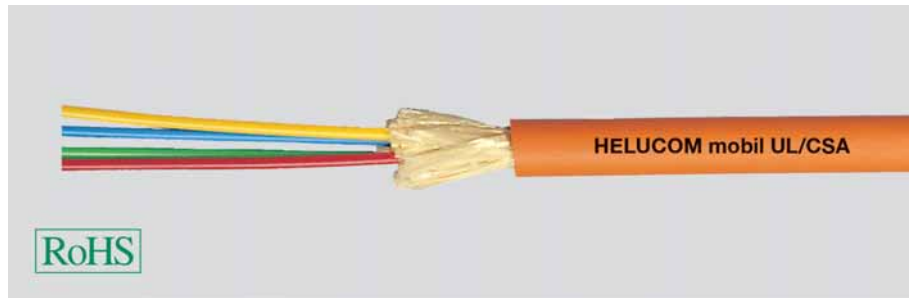

## Cable structure

Core type: Tight buffer  
Strain relief elements: Aramide  
Outer sheath colour: Orange

## Temperature range

Laying, min.: 0°C  
Laying, max.: +50°C  
Operating, min.: -30°C  
Operating, max.: +80°C

## Other data

Max. tensile force: 1200 N  
Max. transverse pressure: 44 N / cm  
Longitudinally water-tight acc. to IEC 60794-1-2-F5  
Applicable UL standards: OFNG UL 1685  
Applicable CSA standards: FT4  
UV-resistant  
Bending cycles acc. to IEC 60794-1-2-E6: 9.000  
Oil-resistant

Designation	Number of fibres	Fibre type	Fibre category	Outer Ø app. mm	Outer sheath material	Inner sheath material	Min. stat. bending radius mm	Flame proof	halogen-free	UL	Weight kg / km	Part no.
Fibre-optic cable	4	Multimode G50/125	OM2	7,0	PVC	PVC	75	yes	no	yes	50	<b>802792</b>
Fibre-optic cable	4	Multimode G62.5/125	OM1	7,0	PVC	PVC	75	yes	no	yes	50	<b>803934</b>
Fibre-optic cable	4	Single-mode E9/125	ITU-T G.652	7,0	PVC	PVC	75	yes	no	yes	50	<b>803935</b>

Dimensions and specifications may be changed without prior notice.

## Application

These HELUCOM® cables were designed as mobile field cables. They are easily wound up on a drum and are very tension-proof. As the outer sheath is tightly anchored on the aramid braiding, it is especially suitable for mobile use. The advantage of these cables is obvious especially where mobile fibre-optic lines have to be installed, such as windturbine projects, TV transmission, supervision of protected areas, etc. This series with PVC jacket is certified according to the **UL/CSA standard OFNG/ FT4**.

# Fibre Optic Cable flexible

WK robust PUR + PVC (UL/CSA)

HELUCOM® WK

AT-V(ZN)H(ZN)11Y, AT-V(ZN)Y(ZN)Y



## Cable structure

Core type: Composite buffered  
Strain relief elements: Aramide  
Outer sheath colour: Black

## Temperature range

Laying, min.: -10°C  
Laying, max.: +50°C  
Operating, min.: -40°C  
Operating, max.: +90°C

## Other data

Max. tensile force: 4800 N  
Max. transverse pressure: 200 N / cm  
Longitudinally water-tight acc. to IEC 60794-1-2-F5  
UV-resistant  
Resistant to hammer impact acc. to IEC 60794-1-2-E4  
Bending cycles acc. to IEC 60794-1-2-E6: 9.000  
Oil-resistant

Designation	Number of fibres	Fibre type	Fibre category	Outer Ø app. mm	Outer sheath material	Inner sheath material	Min. stat. bending radius mm	Flame proof	halogen-free	UL	Weight kg / km	Part no.
AT-V(ZN)H(ZN)11Y	4	Multimode G50/125	OM2	8,5	PUR	ULSZH	100	yes	yes	no	125	<b>803346</b>
AT-V(ZN)Y(ZN)Y	4	Multimode G50/125	OM2	8,5	PVC	PVC	130	yes	no	yes	125	<b>803348</b>
AT-V(ZN)H(ZN)11Y	12	Multimode G50/125	OM2	12,4	PUR	ULSZH	190	yes	yes	no	320	<b>803347</b>
AT-V(ZN)H(ZN)11Y	12	Single-mode E9/125	ITU-T G.652	12,4	PUR	ULSZH	190	yes	yes	no	320	<b>804700</b>
AT-V(ZN)Y(ZN)Y	12	Multimode G50/125	OM2	12,4	PVC	PVC	190	yes	no	yes	320	<b>803349</b>

Dimensions and specifications may be changed without prior notice.

## Application

The HELUCOM® WK range is set apart by its extreme rugged yet highly-flexible design. It is used wherever demanding environmental conditions and extreme movements occur. The tight buffer structure enables the cable to be pre-assembled on site with ease. Applications are for example Windturbines, TV transmissions, mobile field applications, etc.

# Fibre Optic Cable flexible

HELUCOM® WK

AT-V(ZN)YY

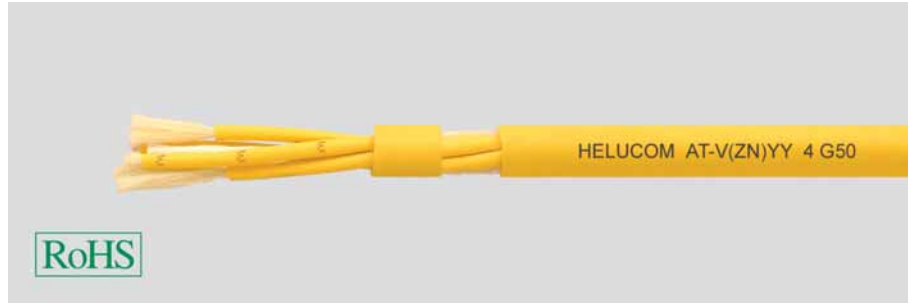

## Cable structure

Core type: Composite buffered  
Strain relief elements: Aramide  
Outer sheath colour: Yellow

## Temperature range

Laying, min.: -10°C  
Laying, max.: +50°C  
Operating, min.: -40°C  
Operating, max.: +90°C

## Other data

Max. tensile force: 1200 N  
Max. transverse pressure: 100 N / cm  
UV-resistant  
Resistant to hammer impact acc. to IEC 60794-1-2-E4  
Bending cycles acc. to IEC 60794-1-2-E6: 15  
Oil-resistant

Designation	Number of fibres	Fibre type	Fibre category	Outer Ø app. mm	Outer sheath material	Inner sheath material	Min. stat. bending radius mm	Flame proof	halogen-free	UL	Weight kg / km	Part no.
Fibre-optic cable	4	Multimode G50/125	OM2	7,4	PVC	PVC	90	yes	no	no	65	<b>803364</b>

Dimensions and specifications may be changed without prior notice.

## Application

The HELUCOM® range is set apart by its extreme rugged yet flexible design. It is used wherever demanding environmental conditions and movements occur. The tight buffer structure enables the cable to be pre-assembled on site with ease. Applications are for example industry applications, TV transmissions, etc.

# Fibre Optic Breakout Cable

outdoor

**HELUCOM**<sup>®</sup>

AT-V(ZN)HH(ZN)B2Y



## Cable structure

Core type: Composite buffered  
GRP support element  
Strain relief elements: Aramide  
Inner sheath material: ULSZH  
Type of armouring: Glass yarns  
Outer sheath material: PE  
Outer sheath colour: Black

## Temperature range

Laying, min.: -5°C  
Laying, max.: +50°C  
Operating, min.: -20°C  
Operating, max.: +60°C

## Other data

Longitudinally water-tight acc. to IEC 60794-1-2-F5  
UV-resistant  
Oil-resistant

Designation	Number of fibres	Fibre type	Fibre category	Outer Ø app. mm	Max. tensile force N	Min. stat. bending radius mm	Max. transverse pressure N / cm	Caloric load app. MJ / m	Weight kg / km	Part no.
AT-V(ZN)HH(ZN)B2Y	4	Multimode G50/125	OM2	13,5	1200	340	300	2,95	140	<b>801352</b>

Dimensions and specifications may be changed without prior notice.

## Application

The HELUCOM<sup>®</sup> range is set apart by its extreme rugged rodent protected design. It is used wherever demanding environmental conditions while fixed installations occur. The tight buffer structure enables the cable to be pre-assembled on site with ease. Applications are for example industry applications, etc.

# Fibre Optic Breakout Cable PROFIBUS

## + PROFINet

outdoor/ direct burial

**HELUCOM**<sup>®</sup>

AT-V(ZN)H(ZN)BH



NEW

### Cable structure

Core type: Composite buffered  
GRP support element  
Strain relief elements: Aramide  
Inner sheath material: ULSZH  
Type of armouring: Glass yarns  
Outer sheath material: FRNC  
Outer sheath colour: Black

### Temperature range

Laying, min.: -20°C  
Laying, max.: +60°C  
Operating, min.: -40°C  
Operating, max.: +70°C

### Other data

Corrosiveness acc. to EN50267-2-3  
Halogen-free acc. to 60754-2  
Flame-resistance acc. to IEC 60332-1 and IEC 60332-3  
Smoke density acc. to IEC 61034  
Longitudinally water-tight acc. to IEC 60794-1-2-F5  
UV-resistant  
Resistant to hammer impact acc. to IEC 60794-1-2-E4  
Oil-resistant

Designation	Number of fibres	Fibre type	Fibre category	Outer Ø app. mm	Max. tensile force N	Min. stat. bending radius mm	Max. transverse pressure N / cm	Weight kg / km	Part no.
AT-V(ZN)H(ZN)BH	4	Single-mode E9/125	ITU-T G.652	9,0	1000	90	600	85	<b>805687</b>

Dimensions and specifications may be changed without prior notice.

### Application

The HELUCOM<sup>®</sup> range is set apart by its rugged design. It is used wherever demanding environmental conditions while fixed installations occur. The tight buffer structure enables the cable to be pre-assembled on site with ease. Applications are for example tray installation or building installation within industry areas. This series can be used within PROFIBUS and PROFINet communications.

# Fibre Optic Breakout Cable PROFIBUS + PROFINet

universal

**HELUCOM**<sup>®</sup>  
AT-W(ZN)YY



NEW

## Cable structure

Core type: Composite buffered  
Strain relief elements: Aramide  
Outer sheath material: PVC  
Outer sheath colour: Green similar to RAL 6018

## Temperature range

Laying, min.: -5°C  
Laying, max.: +50°C  
Operating, min.: -25°C  
Operating, max.: +80°C

## Other data

Flame-resistance acc. to IEC 60332-1 and IEC 60332-3  
Applicable UL standards: OFN UL1651  
Applicable CSA standards: FT4  
UV-resistant  
Oil-resistant

Designation	Number of fibres	Fibre type	Fibre category	Outer Ø app. mm	Max. tensile force N	Min. stat. bending radius mm	Max. transverse pressure N / cm	Weight kg / km	Part no.
AT-W(ZN)YY	2	Multimode G50/125	OM2	4,5 x 7,4	500	45	400	39	<b>805688</b>

Dimensions and specifications may be changed without prior notice.

## Application

The HELUCOM<sup>®</sup> range is set apart by its rugged design. It is used wherever demanding environmental conditions while fixed installations occur. The tight buffer structure enables the cable to be pre-assembled on site with ease. Applications are for example tray installation or building installation within industry areas. This series can be used within PROFIBUS and PROFINet communications.

# Fibre Optic Breakout Cable PROFIBUS

## + PROFINet

fixed installation

HELUCOM®

AT-W(ZN)H(ZN)H



NEW

### Cable structure

Core type: Buffered-fibre  
GRP support element  
Strain relief elements: Aramide  
Outer sheath material: FRNC  
Outer sheath colour: Green similar to RAL 6018

### Temperature range

Laying, min.: -5°C  
Laying, max.: +50°C  
Operating, min.: -40°C  
Operating, max.: +85°C

### Other data

Corrosiveness acc. to EN50267-2-3  
Halogen-free acc. to 60754-2  
Flame-resistance acc. to IEC 60332-1 and IEC 60332-3  
Smoke density acc. to IEC 61034  
Applicable UL standards: OFN UL1651  
Applicable CSA standards: FT1  
UV-resistant  
Resistant to hammer impact acc. to IEC 60794-1-2-E4  
Oil-resistant

Designation	Number of fibres	Fibre type	Fibre category	Outer Ø app. mm	Max. tensile force N	Min. stat. bending radius mm	Max. transverse pressure N / cm	Weight kg / km	Part no.
AT-W(ZN)H(ZN)H	2	Multimode G50/125	OM2	9,2	1200	90	500	80	<b>805689</b>
AT-W(ZN)H(ZN)H	2	Multimode G50/125	OM4	9,2	1200	90	500	80	<b>805691</b>

Dimensions and specifications may be changed without prior notice.

### Application

The HELUCOM® range is set apart by its extreme rugged rodent protected design. It is used wherever demanding environmental conditions while fixed installations occur. The tight buffer structure enables the cable to be pre-assembled on site with ease. Applications are for example Installation in backbones (805691) or in trays within industry areas (805689).



# Fibre Optic Breakout Cable PROFIBUS + PROFINet

Drag Chain

**HELUCOM**<sup>®</sup>  
AT-W(ZN)Y(ZN)11Y



NEW

## Cable structure

Core type: Composite buffered  
GRP support element  
Strain relief elements: Aramide  
Outer sheath material: PUR  
Outer sheath colour: Green similar to RAL 6018

## Temperature range

Laying, min.: -5°C  
Laying, max.: +50°C  
Operating, min.: -40°C  
Operating, max.: +80°C

## Other data

UV-resistant  
Oil-resistant

Designation	Number of fibres	Fibre type	Fibre category	Outer Ø app. mm	Max. tensile force N	Min. stat. bending radius mm	Max. transverse pressure N / cm	Weight kg / km	Part no.
AT-W(ZN)Y(ZN)11Y	2	Multimode G50/125	OM2	10,5	1000	150	700	100	<b>805690</b>

Dimensions and specifications may be changed without prior notice.

## Application

The HELUCOM<sup>®</sup> range is set apart by its rugged and high flexible design. It is used wherever demanding environmental conditions while moving applications occur. The tight buffer structure enables the cable to be pre-assembled on site with ease. Applications are for example Drag Chains. This serie can be used within PROFIBUS and PROFINet communications.

# Fibre Optic Breakout Cable PROFIBUS

## + PROFinet

**HELUCOM®**

AT-V(ZN)H(ZN)BH



NEW

### Cable structure

Core type: Composite buffered  
 GRP support element  
 Strain relief elements: Aramide  
 Type of armouring: Glass yarns  
 Outer sheath material: FRNC  
 Outer sheath colour: Black

### Temperature range

Laying, min.: -10°C  
 Laying, max.: +60°C  
 Operating, min.: -30°C  
 Operating, max.: +70°C

### Other data

Corrosiveness acc. to EN50267-2-3  
 Halogen-free acc. to 60754-2  
 Flame-resistance acc. to IEC 60332-1-2  
 Smoke density acc. to IEC 61034  
 Longitudinally water-tight acc. to IEC 60794-1-2-F5  
 UV-resistant  
 Oil-resistant

Designation	Number of fibres	Fibre type	Fibre category	Outer Ø app. mm	Max. tensile force N	Min. stat. bending radius mm	Max. transverse pressure N / cm	Weight kg / km	Part no.
AT-V(ZN)H(ZN)BH	2	Multimode G50/125	OM2	8,0	1000	140	300	70	<b>805445</b>

Dimensions and specifications may be changed without prior notice.

### Application

The HELUCOM® range is set apart by its extreme rugged rodent protected design. It is used wherever demanding environmental conditions while fixed installations occur. The tight buffer structure enables the cable to be pre-assembled on site with ease. Applications are for example direct burial or tray installation within industry areas. This series can be used within PROFIBUS and PROFinet communications.

# Fibre Optic Breakout Cable PROFIBUS

## + PROFINet

direct burial

**HELUCOM**<sup>®</sup>

AT-WQ(ZN)H(ZN)B2Y



**NEW**

### Cable structure

Core type: Buffered-fibre  
GRP support element  
Strain relief elements: Aramide  
Type of armouring: Glass yarns  
Outer sheath material: PE  
Outer sheath colour: Black

### Temperature range

Laying, min.: -5°C  
Laying, max.: +50°C  
Operating, min.: -40°C  
Operating, max.: +85°C

### Other data

Halogen-free acc. to 60754-2  
Longitudinally water-tight acc. to IEC 60794-1-2-F5  
UV-resistant  
Resistant to hammer impact acc. to IEC 60794-1-2-E4  
Oil-resistant

Designation	Number of fibres	Fibre type	Fibre category	Outer Ø app. mm	Max. tensile force N	Min. stat. bending radius mm	Max. transverse pressure N / cm	Weight kg / km	Part no.
AT-WQ(ZN)H(ZN)B2Y	2	Multimode G50/125	OM2	10,5	1200	105	500	90	<b>805692</b>

Dimensions and specifications may be changed without prior notice.

### Application

The HELUCOM<sup>®</sup> range is set apart by its extreme rugged rodent protected design. It is used wherever demanding environmental conditions while fixed installations occur. The tight buffer structure enables the cable to be pre-assembled on site with ease. Applications are for example direct burial or tray installation out of industry areas. This series can be used for PROFIBUS and PROFINet communications.

# Fibre Optic Cable robust

multimode

HELUCOM®

AT-VYY

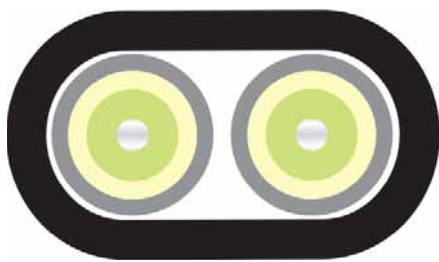

## Cable structure

Core type: Tight buffer  
Strain relief elements: Aramide  
Outer sheath material: PVC  
Outer sheath colour: Black

## Temperature range

Laying, min.: -5°C  
Laying, max.: +50°C  
Operating, min.: -20°C  
Operating, max.: +60°C

## Other data

Flame-resistance acc. to IEC 60332-1-2  
Longitudinally water-tight acc. to IEC 60794-1-2-F5  
UV-resistant  
Oil-resistant

Designation	Number of fibres	Fibre type	Fibre category	Number of fibres per core	Outer Ø app. mm	Max. tensile force N	Min. stat. bending radius mm	Max. transverse pressure N / cm	Caloric load app. MJ / m	Weight kg / km	Part no.
AT-VYY	2	Multimode G62.5/125 OM1		1	6,8 x 10,2	400	110,0	300	1,10	76,0	<b>800126</b>

Dimensions and specifications may be changed without prior notice.

## Application

This HELUCOM® fibre-optic cable is suited for fixed installations in pits and channels, but also for flexible applications as jumper cable. Because of the robust construction with Single- and Overall-jacket you also can use it in industrial areas. With the core-construction, direct plug manufacturing, even on site, poses no problems.

# Fibre Optic Cable flexible

HCS

**HELUCOM®**

I-VH, I-VHH

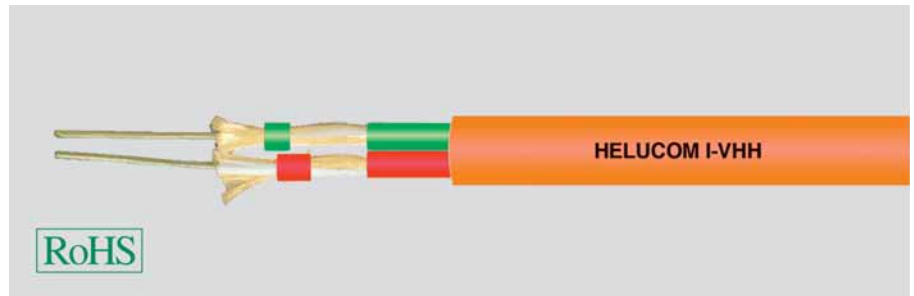
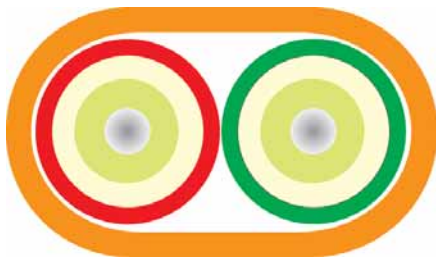

## Cable structure

Core type: Composite buffered  
 Strain relief elements: Aramide  
 Outer sheath material: FRNC  
 Outer sheath colour: Orange

## Temperature range

Laying, min.: -5°C  
 Laying, max.: +50°C  
 Operating, min.: -10°C  
 Operating, max.: +60°C

## Other data

Corrosiveness acc. to EN50267-2-3  
 Halogen-free acc. to 60754-2  
 Flame-resistance acc. to IEC 60332-1-2  
 Smoke density acc. to IEC 61034

Designation	Number of fibres	Fibre type	Outer Ø app. mm	Max. tensile force N	Min. stat. bending radius mm	Max. transverse pressure N / cm	Caloric load app. MJ / m	Weight kg / km	Part no.
I-VH	1	HCS 200/230	2,8	300	40	10	0,26	2,8	<b>800579</b>
I-VHH	2	HCS 200/230	3,8 x 6,6	600	50	10	0,52	30,0	<b>81238</b>

Dimensions and specifications may be changed without prior notice.

## Application

These HELUCOM® HCS fibre lines are suitable for stationary installation indoors. For heavy-duty mechanical requirements, such as application in industrial environments, a version with PUR outer sheath is available on request. With a HCS fibre transmission lengths of up to 300m can be achieved. With the tight buffer construction, direct plug manufacturing, even on site, poses no problems.

# Fibre Optic Breakout Cable robust, flexible

HCS UL/CSA

**HELUCOM**<sup>®</sup>  
I-V(ZN)YY



## Cable structure

Core type: Composite buffered  
Strain relief elements: Aramide  
Outer sheath material: PVC  
Outer sheath colour: Black

## Temperature range

Laying, min.: -20°C  
Laying, max.: +75°C  
Operating, min.: -30°C  
Operating, max.: +85°C

## Other data

Flame-resistance acc. to IEC 60332-1 and IEC 60332-3  
Applicable UL standards: OFNG UL 1685  
Applicable CSA standards: FT4  
UV-resistant  
Oil-resistant

Designation	Number of fibres	Fibre type	Fibre category	Number of fibres per core	Outer Ø app. mm	Max. tensile force N	Min. stat. bending radius mm	Max. transverse pressure N / cm	Caloric load app. MJ / m	Weight kg / km	Part no.
I-V(ZN)YY	2	HCS 200/230	Other	1	7,5	800	100,0	300	1,40	68,0	<b>801733</b>

Dimensions and specifications may be changed without prior notice.

## Application

This HELUCOM<sup>®</sup> HCS fibre cable is suitable for fixed and normal flexible installations. Possible applications are normal and heavy-duty mechanical requirements for example in industrial environments. Because of a special PVC jacket this construction is certified by UL (FT1 and FT4). With the tight buffer construction, direct plug manufacturing, even on site, poses no problems. With a HCS fibre transmission lengths of up to 300m can be achieved.

# Fibre Optic Breakout Cable robust, flexible

HCS

**HELUCOM®**  
I-V(ZN)Y11Y



## Cable structure

Core type: Composite buffered  
Strain relief elements: Aramide  
Outer sheath material: PUR  
Outer sheath colour: Red

## Temperature range

Laying, min.: -5°C  
Laying, max.: +50°C  
Operating, min.: -20°C  
Operating, max.: +70°C

## Other data

Oil-resistant

Designation	Number of fibres	Fibre type	Fibre category	Number of fibres per core	Outer Ø app. mm	Max. tensile force N	Min. stat. bending radius mm	Max. transverse pressure N / cm	Caloric load app. MJ / m	Weight kg / km	Part no.
I-V(ZN)Y11Y	2	HCS 200/230	Other	1	7,0	800	50,0	150	1,014	43,0	<b>800980</b>

Dimensions and specifications may be changed without prior notice.

## Application

This HELUCOM® HCS fibre cable is suitable for fixed installation. Possible applications are normal and heavy-duty mechanical requirements for example in industrial environments. With the tight buffer construction, direct plug manufacturing, even on site, poses no problems. With a HCS fibre transmission lengths of up to 300m can be achieved.

# Fibre Optic Breakout Cable flexible

HCS

**HELUCOM**<sup>®</sup>  
AT-V(ZN)HH



## Cable structure

Core type: Composite buffered  
GRP support element  
Strain relief elements: Aramide  
Outer sheath material: FRNC  
Outer sheath colour: Black

## Temperature range

Laying, min.: -20°C  
Laying, max.: +50°C  
Operating, min.: -20°C  
Operating, max.: +70°C

## Other data

Corrosiveness acc. to EN50267-2-3  
Halogen-free acc. to 60754-2  
Flame-resistance acc. to IEC 60332-1-2  
Smoke density acc. to IEC 61034  
UV-resistant  
Oil-resistant

Designation	Number of fibres	Fibre type	Fibre category	Number of fibres per core	Outer Ø app. mm	Max. tensile force N	Min. stat. bending radius mm	Max. transverse pressure N / cm	Caloric load app. MJ / m	Weight kg / km	Part no.
AT-V(ZN)HH	4	HCS 200/230	Other	1	9,0	800	225,0	100	1,60	76,0	<b>802260</b>

Dimensions and specifications may be changed without prior notice.

## Application

This HELUCOM<sup>®</sup> HCS fibre cable is suitable for fixed and normal flexible installation. Possible applications are normal requirements and also limited industrial environments. The tight buffer structure enables the cable to be pre-assembled on site with ease. With a HCS fibre transmission lengths of up to 300m can be achieved.



# Fibre Optic Breakout Cable robust

HCS

**HELUCOM®**

AT-VQH(ZN)B2Y



## Cable structure

Core type: Composite buffered  
GRP support element  
Strain relief elements: Aramide  
Type of armouring: Glass yarns  
Outer sheath material: PE  
Outer sheath colour: Black

## Temperature range

Laying, min.: -5°C  
Laying, max.: +50°C  
Operating, min.: -25°C  
Operating, max.: +70°C

## Other data

Corrosiveness acc. to EN50267-2-3  
Halogen-free acc. to 60754-2  
Longitudinally water-tight acc. to IEC 60794-1-2-F5  
UV-resistant  
Oil-resistant

Designation	Number of fibres	Fibre type	Fibre category	Number of fibres per core	Outer Ø app. mm	Max. tensile force N	Min. stat. bending radius mm	Max. transverse pressure N / cm	Caloric load app. MJ / m kg / km	Weight	Part no.
AT-VQH(ZN)B2Y	2	HCS 200/230	Other	1	11,0	1500	200,0	500	2,10	90,0	<b>801196</b>

Dimensions and specifications may be changed without prior notice.

## Application

This HELUCOM® HCS fibre cable is suitable for fixed installation outdoors. Possible applications are normal and heavy-duty mechanical requirements for example in industrial environments. This is the reason we also equipped the cable with a non-metallic rodent-protection. With the tight buffer construction, direct plug manufacturing, even on site, poses no problems. With a HCS fibre transmission lengths of up to 300m can be achieved.

# Fibre Optic Universal Cable

HCS

HELUCOM®

A/I-DQ(ZN)BH



## Cable structure

Core type: Loose tube  
Strain relief elements: Glass yarns  
Type of armouring: Glass yarns  
Outer sheath material: FR/LSOH  
Outer sheath colour: Black

## Temperature range

Laying, min.: -5°C  
Laying, max.: +50°C  
Operating, min.: -20°C  
Operating, max.: +70°C

## Other data

Corrosiveness acc. to EN50267-2-3  
Halogen-free acc. to 60754-2  
Flame-resistance acc. to IEC 60332-1-2  
Smoke density acc. to IEC 61034  
Longitudinally water-tight acc. to IEC 60794-1-2-F5  
UV-resistant

Designation	Number of fibres	Fibre type	Fibre category	Number of fibres per core	Outer Ø app. mm	Max. tensile force N	Min. stat. bending radius mm	Max. transverse pressure N / cm	Caloric load app. MJ / m	Weight kg / km	Part no.
A/I-DQ(ZN)BH	4	HCS 200/230	Other	4	8,5	1500	130,0	150	2,00	76,0	<b>801198</b>
A/I-DQ(ZN)BH	8	HCS 200/230	Other	8	8,5	1500	130,0	150	2,00	79,0	<b>802001</b>
A/I-DQ(ZN)BH	12	HCS 200/230	Other	12	8,5	1500	130,0	150	2,00	82,0	<b>802002</b>
A/I-DQ(ZN)BH	24	HCS 200/230	Other	8	17,7	6000	265,0	300	3,20	280,0	<b>802003</b>
A/I-DQ(ZN)BH	48	HCS 200/230	Other	8	18,9	6000	285,0	300	3,20	355,0	<b>802004</b>

Dimensions and specifications may be changed without prior notice.

## Application

These HELUCOM® fibre-optic cables are available either as central bundle core cable or as stranded versions. They are suitable for fixed indoor and outdoor cabling of buildings and industry facilities. They are used in particular if the installation is to be done in one piece from the inside to the outside without additional use of couplings. With their black UV-resistant outer sheath and the non-metallic rodent protection, they are perfectly suited for outdoor use. The halogen-free outer sheath makes installation inhouse possible without any problems.

# Plastic Fibre cable industry

POF/PE

**HELUCOM®**

I-V2Y, I-V2Y(ZN)11Y

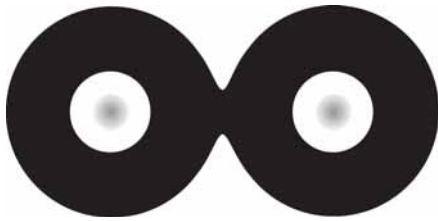

## Cable structure

Fibre type: POF 980/1000  
Fibre cladding: PE

## Optical characteristic

Refractive index core: 1,492  
Refractive index cladding: 1,419  
Numerical aperture: 0,5  
Attenuation see table

## Temperature range

Laying, min.: -20°C  
Laying, max.: +80°C  
Operating, min.: -20°C  
Operating, max.: +80°C

Designation	Outer sheath material	Sheath colour	Outer Ø app. mm	Max. tensile force N	Min. stat. bending radius mm	Fibre attenuation	Oil-resistant	Acc. to DESINA®	Weight kg / km	Part no.
I-V2Y 1P 980/1000	PE	Black	2,2	70	25,0	160A1	no	no	4,0	<b>80532</b>
I-V2Y 2P 980/1000	PE	Black	2,2 x 4,4	140	25,0	160A1	no	no	8,0	<b>80388</b>
I-V2Y(ZN)11Y 1P 980/1000, high flexible	PUR	Violet	5,8	400	30,0	230A1	yes	yes	30,0	<b>81611</b>
I-V2Y(ZN)11Y 2P 980/1000, high flexible	PUR	Violet	6,0	400	31,0	230A1	yes	yes	36,0	<b>80629</b>
I-V2Y(ZN)11Y 2P 980/1000, fixed installation	PUR	Violet	6,0	400	31,0	230A1	yes	yes	36,0	<b>81882</b>
I-V2Y(ZN)11Y 4P 980/1000, high flexible	PUR	Violet	7,1	400	45,0	230A1	yes	yes	65,0	<b>80630</b>
I-V2Y(ZN)11Y 2P 980/1000 + 2x1mm <sup>2</sup> Cu	PUR	Red	7,8	200	70,0	230A1	yes	no	60,0	<b>82032</b>
I-V2Y(ZN)11Y 2P 980/1000 + 3x1,5mm <sup>2</sup> Cu	PUR	Red	11,0	200	70,0	230A1	yes	no	132,0	<b>82033</b>

Dimensions and specifications may be changed without prior notice.

## Application

HELUCOM® plastic-fibre cables are used in mechanical engineering, both in mobile and fixed applications. With different constructions, such as PUR outer sheaths, special strain relief components, hybrid construction with copper cores for power supply or only raw fibre cables, any possible fields of application are covered. Due to their solidity and their simple adjustability on site, the plastic-fibres (PMMA) are particularly suitable for applications where trouble-free data transmission is necessary under heavy-duty conditions.

# Plastic Fibre Cable PROFInet

POF/PA

HELUCOM®

I-V4Y(ZN)Y (type B), I-V4Y(ZN)11Y (type C)



NEW

## Cable structure

Fibre type: POF 980/1000  
Fibre cladding: PA

## Optical characteristic

Refractive index core: 1,492  
Refractive index cladding: 1,419  
Numerical aperture: 0,5  
Attenuation see table

## Temperature range

Laying, min.: -10°C  
Laying, max.: +50°C  
Operating, min.: -30°C  
Operating, max.: +70°C

Designation	Outer sheath material	Sheath colour	Outer Ø app. mm	Max. tensile force N	Min. stat. bending radius mm	Fibre attenuation	Oil-resistant	Acc. to DESINA®	Weight kg / km	Part no.
I-V4Y(ZN)Y 2P980/1000µm, fixed installation	PVC	Green	7,8	100	100,0	160A1	yes	no	59,0	<b>805686</b>
I-V4Y(ZN)11Y 2P980/1000 green, Drag Chain	PUR	Green	8,0	200	120,0	180A1	yes	no	60,0	<b>805838</b>

Dimensions and specifications may be changed without prior notice.

## Application

Signal lines as plastic optical fibre. The use of these transmission systems significantly reduces the number of different cables in a planned bus installation in machine tools operations. Furthermore, possible EMC problems are prevented by the metal-free construction. The main fields of these cables are in machine construction and automobile industry. Installations for example in fixed installed rough areas (type B) or in Drag Chains (type C) are possible. The types on this page are especially constructed for communication within PROFInet systems.

# Plastic Fibre Cable PROFIBUS

POF/PA

**HELUCOM®**  
I-V4Y(ZN)Y



**NEW**

## Cable structure

Fibre type: POF 980/1000  
Fibre cladding: PA

## Optical characteristic

Refractive index core: 1,492  
Refractive index cladding: 1,419  
Numerical aperture: 0,5  
Attenuation see table

## Temperature range

Laying, min.: -10°C  
Laying, max.: +50°C  
Operating, min.: -30°C  
Operating, max.: +70°C

Designation	Outer sheath material	Sheath colour	Outer Ø app. mm	Max. tensile force N	Min. stat. bending radius mm	Fibre attenuation	Oil-resistant	Acc. to DESINA®	Weight kg / km	Part no.
I-V4Y(ZN)Y 2P980/1000µm, fixed installation	PVC	Violet	7,8	100	100,0	160A1	yes	yes	59,0	<b>801280</b>

Dimensions and specifications may be changed without prior notice.

## Application

Signal lines as plastic optical fibre. The use of these transmission systems significantly reduces the number of different cables in a planned bus installation in machine tools operations. Furthermore, possible EMC problems are prevented by the metal-free construction. The main application of these cables are in machine construction and automobile industry. The type on this page is especially constructed for communication within PROFIBUS systems.

# Plastic Fibre Cable Automotive

POF/PA

HELUCOM®

I-V4Y(ZN)11Y



## Cable structure

Fibre type: POF 980/1000  
Fibre cladding: PA

## Optical characteristic

Refractive index core: 1,492  
Refractive index cladding: 1,419  
Numerical aperture: 0,5  
Attenuation see table

## Temperature range

Laying, min.: -5°C  
Laying, max.: +50°C  
Operating, min.: -20°C  
Operating, max.: +70°C

Designation	Outer sheath material	Sheath colour	Outer Ø app. mm	Max. tensile force N	Min. stat. bending radius mm	Fibre attenuation	Oil-resistant	Acc. to DESINA®	Weight kg / km	Part no.
I-V4Y(ZN)11Y 2P980/1000 RUGGED	PUR	Red	8,0	100	50,0	160A1	yes	no	42,0	<b>801200</b>
I-V4Y(ZN)11Y 2P980/1000 FLEX RUGGED	PUR	Red	8,0	100	50,0	250A1	yes	no	51,0	<b>801201</b>
I-V4Y(ZN)11Y 2P980/1000 HEAVY	PUR	Red	6,0	100	30,0	160A1	yes	no	28,0	<b>801202</b>

Dimensions and specifications may be changed without prior notice.

## Application

Signal lines as plastic optical fibre. The use of these transmission systems significantly reduces the number of different cables in a planned bus installation in machine tools operations. Furthermore, possible EMC problems are prevented by the metal-free construction. The main application of these cables are in machine construction and automobile industry (PA version).

## FIBRESPECIFICATIONS

<b>Graded index fibres</b>			
<b>Specification</b>		<b>Fibre type G 50/125</b>	<b>Fibre type G 62,5/125</b>
Fibre categorie		OM2 Standard fibre	OM1 Standard fibre
Core diameter		50 ± 3 µm	62,5 ± 3 µm
Numerical aperture		0,200 ± 0,015	0,275 ± 0,015
Typ. attenuation	850 nm	2,5 dB/km	3,0 dB/km
	1300 nm	0,7 dB/km	1,0 dB/km
Min. bandwidth	850 nm	500 MHz x km	200 MHz x km
	1300 nm	500 MHz x km	500 MHz x km
Cladding diameter		125 ± 1 µm	
Primary coating diameter		245 ± 10 µm	
Core noncircularity		< 5 %	
Cladding concentricity error		< 3,0 µm	
Cladding nonconcentricity		< 2,0 %	
<b>Specification</b>		<b>Fibre type G 50/125</b>	
Fibre categorie		OM3 Standard fibre	OM4 Standard fibre
Core diameter		50 ± 3 µm	50 ± 3 µm
Numerical aperture		0,200 ± 0,015	0,200 ± 0,015
Typ. attenuation	850 nm	2,5 dB/km	3,0 dB/km
	1300 nm	0,5 dB/km	1,0 dB/km
Min. bandwidth	850 nm	1500 MHz x km	3500 MHz x km
	1300 nm	500 MHz x km	500 MHz x km
Cladding diameter		125 ± 1 µm	125 ± 1 µm
Primary coating diameter		245 ± 10 µm	245 ± 10 µm
Core noncircularity		< 5 %	< 5 %
Cladding concentricity error		< 3,0 µm	< 6,0 µm
Cladding nonconcentricity		< 2,0 %	< 2,0 %

<b>Single-Mode-Fibre</b>			
<b>Specification</b>		<b>Fibre type E9...10/125 (single mode)</b>	
Fibre categorie		ITU-T G. 652.d	ITU-T G 657.A1
Attenuation	1310 nm	0,36 dB/km	0,34 dB/km
	1550 nm	0,22 dB/km	0,20 dB/km
Dispersion	1285 - 1330 nm	< 3,5 ps/(nm x km)	
	1550 nm	< 19 ps/(nm x km)	< 17,5 ps/(nm x km)
Wave length		1312 nm	
Mode field diameter at 1310 nm		9,3 ± 0,5 µm	9,2 ± 0,3 µm
Cladding diameter		125 ± 1 µm	125 ± 1 µm
Primary coating diameter		245 ± 10 µm	245 ± 10 µm
Cut-off wavelength		< 1250 nm	< 126 mm
Cladding concentricity error		≤ 0,8 µm	≤ 0,5 µm
Cladding nonconcentricity		< 1,0 %	< 0,8 %

<b>POF and HCS-Fibre</b>			
<b>Specification</b>		<b>Fibre type POF P980/1000</b>	<b>Fibre type HCS K200/230</b>
Core diameter		980 µm	200 µm
Numerical aperture		0,5	0,37
Typ. attenuation	650nm	160 dB/km	10 db/km
	850nm	-	8 dB/km
Min. Bandwidth	650nm	10 MHz x 100m	17 MHz x km
	850nm	-	20 MHz x km
Wallthickness		1000 µm	230 µm

Fibres with other parameteres on request

■ FIBRE-OPTIC CABLES-CODE ACC. TO DIN VDE 0888

□	—	□	□	□	□	□	□	□	□	□	□	□	□	□
1		2	3	4	5	6	7	8	9	10	11	12	13	14
														Lg layerstranding
														Bandwidth in MHz x km (GF) dispersion parameter in $\frac{\text{ps}}{\text{nm}\times\text{km}}$
														Wavelength B $\hat{=}$ 850 nm F $\hat{=}$ 1300 nm H $\hat{=}$ 1550 nm
														Attenuation coefficient in dB/km
														Cladding diameter in $\mu\text{m}$
														Core diameter in $\mu\text{m}$ of graded index fibre Field diameter in $\mu\text{m}$ of single mode fibre
														Design E Single mode fibre G Gradded index fibre
														Number of fibres Number of fibres per buffer Number of multifibres per buffer
														Y PVC-sheath H Sheath with halogenfree material B Armouring BY Armouring with PVC-protective covering sheath B2Y Armouring mit PE-protective covering sheath
														Y PVC-sheath 2Y PE-sheath 4Y PA-sheath 11Y PUR-sheath (L)2Y PE-Laminated sheath (ZN)2Y PE-sheath with nometallic strength menber (L)(ZN)2Y PE-Laminated sheath with nometallic strength menber
														F Filling of the cable core with petroleum jelly Q Swellingmaterial
														S Metallic element in the cable core
														V Tight buffer K Composite buffer fibre H Loose buffer nonfilled W Loose buffer, filled B Multifibre buffer nonfilled D Multifibre buffer filles
														I Indoor cable A Outdoor cable AT Outdoor fan out cable





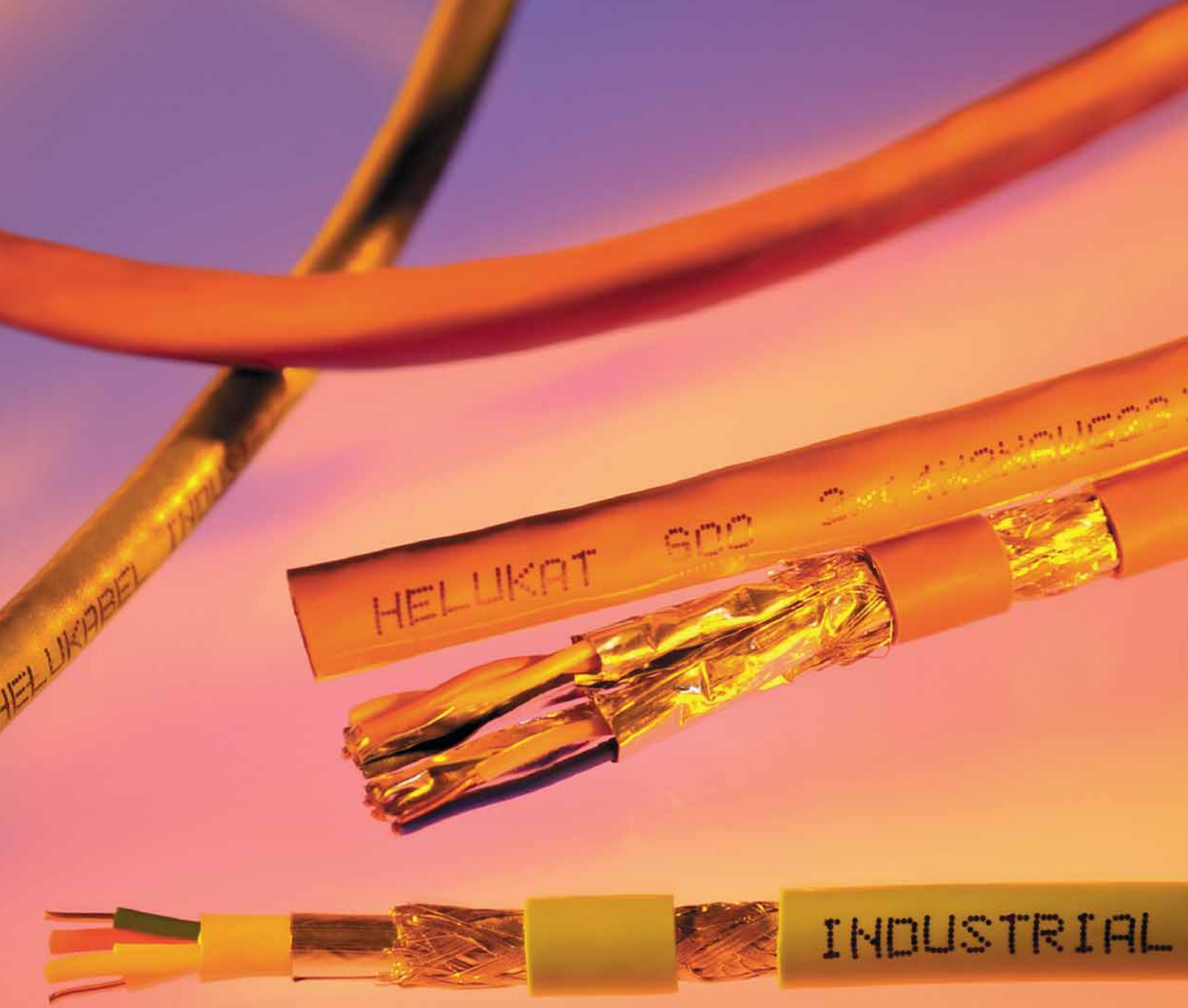

LAN Cable 300 U/UTP UL

**LAN Cable 155 U/UTP**

LAN Cable 100 U/UTP flex

LAN Cable 450 F/FTP

**LAN Cable 1000 S/FTP duplex**

LAN Cable 200 SF/UTP flex

Multimedia cable 1500 S/FTP

# ■ COPPER DATA CABLES HELUKAT®

<b>Designation</b>			<b>Page</b>
<b>Data cable unshielded</b>			
LAN cable	HELUKAT® 155	U/UTP	<b>90</b>
LAN cable	HELUKAT® 155	U/UTP UL	<b>91</b>
LAN cable	HELUKAT® 300	U/UTP UL	<b>92</b>
LAN cable	HELUKAT® 300	U/UTP FRNC	<b>93</b>
LAN cable	HELUKAT® 600	U/UTP FRNC	<b>94</b>
LAN cable	HELUKAT® 100	U/UTP flex	<b>95</b>
LAN cable	HELUKAT® 300	U/UTP flex	<b>96</b>
LAN cable	HELUKAT® 300A	U/UTP, outdoor	<b>97</b>
<b>Data cable shielded</b>			
LAN cable	HELUKAT® 155	F/UTP	<b>98</b>
LAN cable	HELUKAT® 100	F/UTP flex	<b>99</b>
LAN cable	HELUKAT® 100	F/UTP FE60	<b>100</b>
LAN cable	HELUKAT® 200	F/UTP Flex, UL	<b>101</b>
LAN cable	HELUKAT® 200A	F/UTP, outdoor	<b>102</b>
LAN cable	HELUKAT® 200	SF/UTP	<b>103</b>
LAN cable	HELUKAT® 200	SF/UTP duplex	<b>104</b>
LAN cable	HELUKAT® 200	SF/UTP flex	<b>105</b>
LAN cable	HELUKAT® 300	U/FTP, UL	<b>106</b>
LAN cable	HELUKAT® 450	F/FTP	<b>107</b>
LAN cable	HELUKAT® 450	F/FTP duplex	<b>108</b>
LAN cable	HELUKAT® 500	F/FTP	<b>109</b>
LAN cable	HELUKAT® 500	F/FTP duplex	<b>110</b>
LAN cable	HELUKAT® 500	U/FTP, flex	<b>111</b>
LAN cable	HELUKAT® 600	S/FTP	<b>112</b>
LAN cable	HELUKAT® 600	S/FTP duplex	<b>113</b>
LAN cable	HELUKAT® 600	S/FTP flex	<b>114</b>
LAN cable	HELUKAT® 600A	S/FTP PVC/PVC, outdoor	<b>115</b>
LAN cable	HELUKAT® 600E	S/FTP PVC, direct burial	<b>116</b>
LAN cable	HELUKAT® 600AE	S/FTP FRNC/PE, direct burial, armoured	<b>117</b>
LAN cable	HELUKAT® 1200	S/FTP	<b>118</b>
LAN cable	HELUKAT® 1200	S/FTP duplex	<b>119</b>
LAN cable	HELUKAT® 1200	S/FTP	<b>120</b>
LAN cable	HELUKAT® 1200	S/FTP duplex	<b>121</b>
Multimedia cable	HELUKAT® 1500	S/FTP	<b>122</b>
Multimedia cable	HELUKAT® 1500	S/FTP duplex	<b>123</b>
<b>Data cable IBM</b>			
LAN cable	HELUKABEL®	IBM P/N 33G2772	<b>124</b>

# LAN Cable

Category 5e

**HELUKAT® 155**  
U/UTP

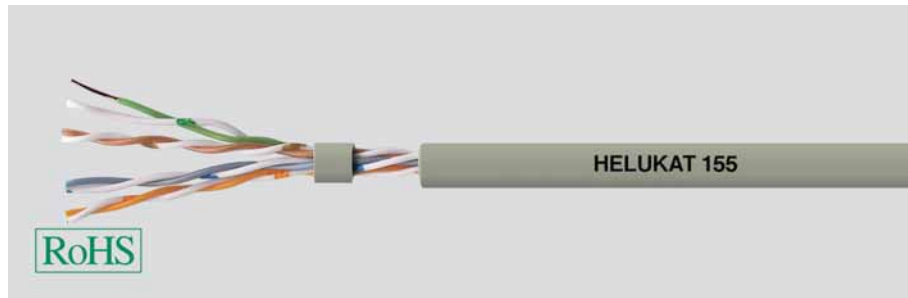
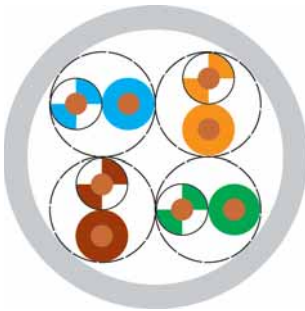

## Cable structure

Inner conductor Ø:	0,51 mm
Conductor material:	Copper, bare
Core insulation:	PE
Core colours:	whbu/bu, whog/og, whgn/gn, whbn/bn
Separator:	-
Screen over stranding element:	-
Screen 1 over stranding:	-
Screen 2 over stranding:	-
Outer sheath material:	PVC
Outer diameter:	app. 4,9 mm
Outer sheath colour:	Grey

## U/UTP 4x2xAWG 24/1 PVC

## Electrical data

Characteristic impedance:	100 Ohm ± 15 Ohm at 1 to 100 MHz 100 Ohm ± 20 Ohm at 101 to 155 MHz
Loop resistance:	190 Ohm/km max.
Mutual capacitance:	50 nF/km nom.
Rel. propagation velocity:	66 %

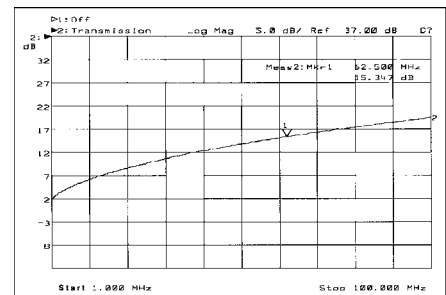

## Typical values

Frequency (MHz)	10	16	62,5	100	155
Attenuation (dB/100m)	6,3	8,0	16,5	21,3	26,8
Next (dB)	50,3	47,3	38,4	35,3	33,0
ACR (dB)	44,0	39,3	21,9	14,0	6,2

## Technical data

Weight:	app. 26 kg/km
bending radius, repeated:	40 mm
Operating temperature range min.:	-20°C
Operating temperature range max.:	+60°C
Caloric load, approx. value:	0,40 MJ/m
Copper weight:	17,00 kg/km

## Norms

Acc. to ISO/IEC 11801, Acc. to EN 50173, Acc. to EIA/TIA 568-A, Category 5e

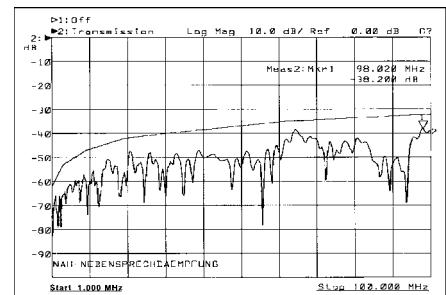

## Application

HELUKAT®155 data cables are used in the tertiary, but also in the secondary level of a network. They are characterized by large performance reserves and outstanding performance. They can be used to implement services such as Fast Ethernet, Ethernet, ATM155, FDDI, token ring 4/16 Mbit/s, or ISDN absolutely trouble-free. Likewise, the mechanical characteristics are perfectly suited for the application in tight cable channels and platforms due to their optimized construction.

## Part no.

**80053**, U/UTP 4x2xAWG24/1 PVC (UTP)

Dimensions and specifications may be changed without prior notice.

# LAN Cable

Category 5e

**HELUKAT® 155**

U/UTP UL

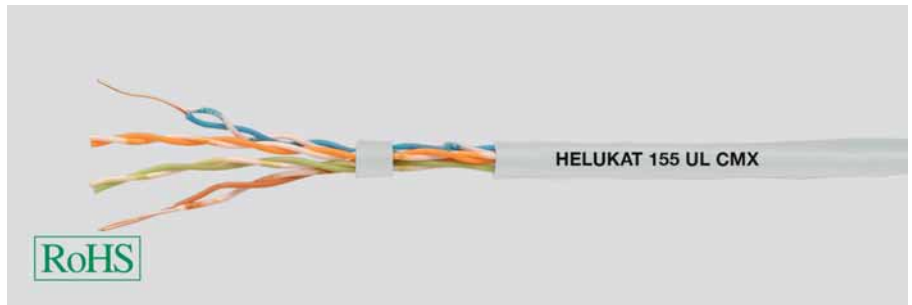
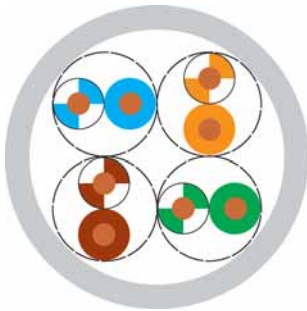

## Cable structure

Inner conductor Ø:	0,53 mm
Conductor material:	Copper, bare
Core insulation:	PE
Core colours:	whbu/bu, whog/og, whgn/gn, whbn/bn
Separator:	-
Screen over stranding element:	-
Screen 1 over stranding:	-
Screen 2 over stranding:	-
Outer sheath material:	PVC
Outer diameter:	app. 5,2 mm
Outer sheath colour:	Grey

## U/UTP 4x2xAWG 24/1 PVC, UL

## Electrical data

Characteristic impedance:	100 Ohm ± 15 Ohm at 1 to 100 MHz 100 Ohm ± 20 Ohm at 101 to 155 MHz
Loop resistance:	190 Ohm/km max.
Mutual capacitance:	50 nF/km nom.
Rel. propagation velocity:	66 %

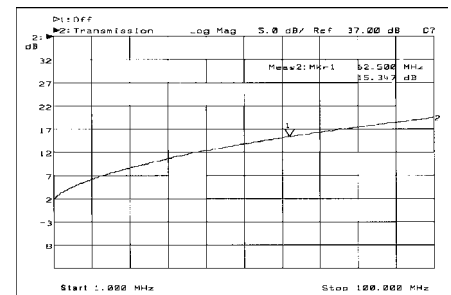

## Typical values

Frequency (MHz)	10	16	62,5	100	155
Attenuation (dB/100m)	6,1	7,7	15,2	19,9	22,7
Next (dB)	65,0	63,0	53,0	40,0	37,0
ACR (dB)	58,9	55,3	37,8	20,1	14,3

## Technical data

Weight:	app. 35 kg/km
bending radius, repeated:	42 mm
Operating temperature range min.:	-20°C
Operating temperature range max.:	+60°C
Caloric load, approx. value:	0,43 MJ/m
Copper weight:	17,00 kg/km

## Norms

Acc. to ISO/IEC 11801, Acc. to EN 50173, Acc. to EIA/TIA 568-A, Category 5e, Flame-retardant acc. to IEC 60332-1-2, Smoke density acc. to IEC 61034, CMX 444

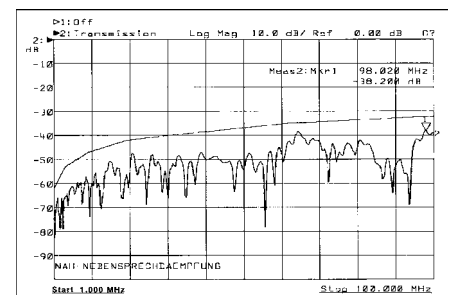

## Application

HELUKAT®155 data cables are used in the tertiary, but also in the secondary level of a network. They are characterized by large performance reserves and outstanding performance. They can be used to implement services such as Gigabit Ethernet, Fast Ethernet, Ethernet, ATM155, FDDI, token ring 4/16 Mbit/s, or ISDN absolutely trouble-free. Likewise, the mechanical characteristics are perfectly suited for the application in tight cable channels and platforms due to their optimized construction. This type is certified according UL because of the special PVC jacket

## Part no.

**802171**, U/UTP 4x2xAWG24/1 PVC UL (UTP)

Dimensions and specifications may be changed without prior notice.

# LAN Cable

Category 6

**HELUKAT® 300**

U/UTP UL

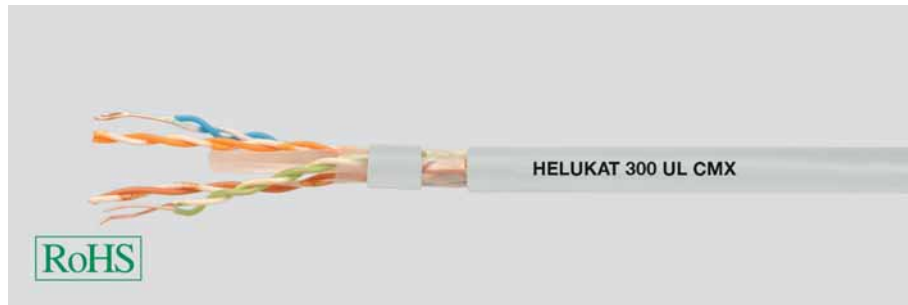
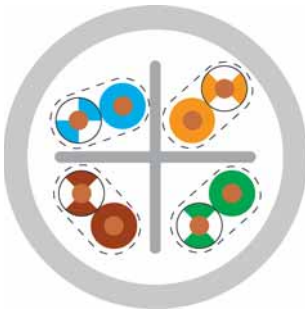

## Cable structure

Inner conductor Ø:  
Conductor material:  
Core insulation:  
Core colours:  
Separator:  
Screen over stranding element:  
Screen 1 over stranding:  
Screen 2 over stranding:  
Outer sheath material:  
Outer diameter:  
Outer sheath colour:

## U/UTP 4x2xAWG 24/1 PVC, UL

0,55 mm  
Copper, bare  
PE  
whbu/bu, whog/og, whgn/gn, whbn/bn  
Polyester foil over stranded bundle  
-  
-  
-  
PVC  
app. 6,3 mm  
Grey

## Electrical data

Characteristic impedance: 100 Ohm ± 15 Ohm at 1 to 100 MHz  
100 Ohm ± 20 Ohm at 101 to 300 MHz  
Loop resistance: 190 Ohm/km max.  
Mutual capacitance: 50 nF/km nom.  
Rel. propagation velocity: 67 %

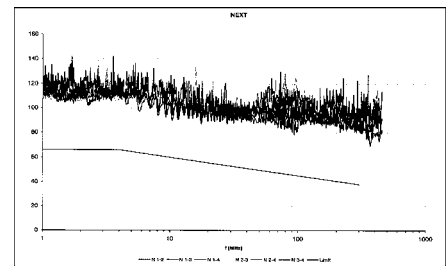

## Typical values

Frequency (MHz)	10	16	62,5	100	155	200	300
Attenuation (dB/100m)	5,6	7,0	14,3	18,2	22,9	26,0	32,5
Next (dB)	72,0	70,0	65,0	63,0	60,0	57,0	55,0
ACR (dB)	66,4	63,0	50,7	44,8	37,1	31,0	22,5

## Technical data

Weight: app. 46 kg/km  
bending radius, repeated: 55 mm  
Operating temperature range min.: -20°C  
Operating temperature range max.: +60°C  
Caloric load, approx. value: 0,68 MJ/m  
Copper weight: 20,00 kg/km

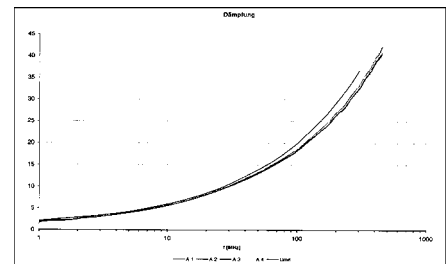

## Norms

Acc. to ISO/IEC 11801, Acc. to EN 50173, Acc. to EIA/TIA 568-A, Category 6, Flame-retardant acc. to IEC 60332-1-2, Smoke density acc. to IEC 61034, CMX 444

## Application

HELUKAT®300 data cables are used in the tertiary, but also in the secondary level of a network. They are characterized by large performance reserves and outstanding performance. They can be used to implement services such as Gigabit Ethernet, Fast Ethernet, Ethernet, ATM155, FDDI, token ring 4/16 Mbit/s, or ISDN absolutely trouble-free. Likewise, the mechanical characteristics are perfectly suited for the application in tight cable channels and platforms due to their optimized construction. This type is certified according UL because of the special PVC jacket

## Part no.

**802172**, U/UTP 4x2xAWG24/1 PVC UL (UTP)

Dimensions and specifications may be changed without prior notice.

# LAN Cable

Category 6

**HELUKAT® 300**

U/UTP FRNC

NEW



## Cable structure

Inner conductor Ø:	0,55 mm
Conductor material:	Copper, bare
Core insulation:	PE
Core colours:	whbu/bu, whog/og, whgn/gn, whbn/bn
Separator:	Polyester foil over stranded bundle
Screen over stranding element:	-
Screen 1 over stranding:	-
Screen 2 over stranding:	-
Outer sheath material:	FRNC
Outer diameter:	app. 6,8 mm
Outer sheath colour:	Green similar to RAL 6018

## U/UTP 4x2xAWG 24/ 1 FRNC

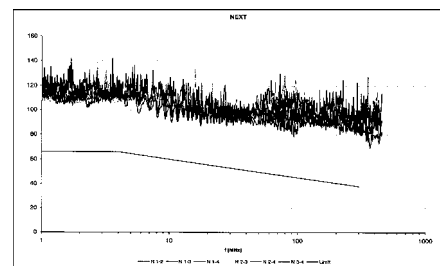

## Electrical data

Characteristic impedance:	100 Ohm ± 15 Ohm at 1 to 100 MHz 100 Ohm ± 20 Ohm at 101 to 300 MHz
Loop resistance:	190 Ohm/km max.
Mutual capacitance:	50 nF/km nom.
Rel. propagation velocity:	67 %

## Typical values

Frequency (MHz)	10	16	62,5	100	155	200	300
Attenuation (dB/100m)	5,6	7,0	14,3	18,2	22,9	26,0	32,5
Next (dB)	72,0	70,0	65,0	63,0	60,0	57,0	55,0
ACR (dB)	66,4	63,0	50,7	44,8	37,1	31,0	22,5

## Technical data

Weight:	app. 46 kg/km
bending radius, repeated:	55 mm
Operating temperature range min.:	-20°C
Operating temperature range max.:	+60°C
Caloric load, approx. value:	0,125 MJ/m
Copper weight:	20,00 kg/km

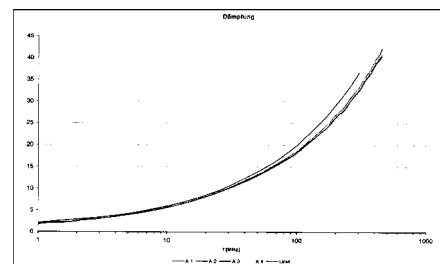

## Norms

Acc. to ISO/IEC 11801, Acc. to EN 50173, Acc. to EIA/TIA 568-A, Category 6, Flame-retardant acc. to IEC 60332-1-2, Smoke density acc. to IEC 61034, Halogen-free acc. to 60754-2, Corrosiveness acc. to EN50267-2-3

## Application

HELUKAT®300 data cables are used in the tertiary, but also in the secondary level of a network. They are characterized by large performance reserves and outstanding performance. They can be used to implement services such as Gigabit Ethernet, Fast Ethernet, Ethernet, ATM155, FDDI, token ring 4/16 Mbit/s, or ISDN absolutely trouble-free. Likewise, the mechanical characteristics are perfectly suited for the application in tight cable channels and platforms due to their optimized construction.

## Part no.

**804766**, U/UTP 4x2xAWG24/1 FRNC (UTP)

Dimensions and specifications may be changed without prior notice.

# LAN Cable

Category 6

**HELUKAT® 600**

U/UTP FRNC

NEW



## Cable structure

Inner conductor Ø:  
Conductor material:  
Core insulation:  
Core colours:  
Separator:  
Screen over stranding element:  
Screen 1 over stranding:  
Screen 2 over stranding:  
Outer sheath material:  
Outer diameter:  
Outer sheath colour:

## U/UTP 4x2xAWG 23/ 1 FRNC

0,56 mm  
Copper, bare  
PE  
whbu/bu, whog/og, whgn/gn, whbn/bn  
Polyester foil over stranded bundle  
-  
-  
FRNC  
app. 6,5 mm  
Grey similar to RAL 7035

## Electrical data

Characteristic impedance:  
Loop resistance:  
Mutual capacitance:  
Rel. propagation velocity:

100 Ohm ± 15 Ohm at 1 to 100 MHz  
100 Ohm ± 20 Ohm at 101 to 600 MHz  
150 Ohm/km max.  
50 nF/km nom.  
67 %

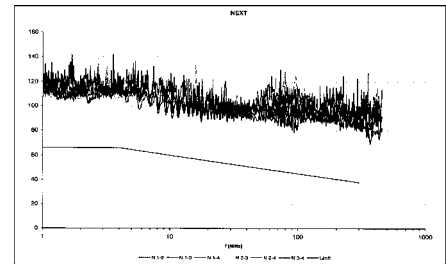

## Typical values

Frequency (MHz)	10	16	62,5	100	155	200	300	500	600
Attenuation (dB/100m)	5,5	6,9	14,3	18,0	22,1	25,3	31,8	39,8	44,1
Next (dB)	72,0	70,0	65,0	63,0	60,0	57,0	55,0	53,0	49,0
ACR (dB)	66,5	63,1	50,7	45,0	37,9	31,7	23,2	13,2	4,9

## Technical data

Weight: app. 52 kg/km  
bending radius, repeated: 55 mm  
Operating temperature range min.: -20°C  
Operating temperature range max.: +60°C  
Caloric load, approx. value: 0,135 MJ/m  
Copper weight: 20,00 kg/km

## Norms

Acc. to ISO/IEC 11801, Acc. to EN 50173, Acc. to EIA/TIA 568-A, Category 6A, Flame-retardant acc. to IEC 60332-1-2, Smoke density acc. to IEC 61034, Halogen-free acc. to 60754-2, Corrosiveness acc. to EN50267-2-3, CMX 444

## Application

HELUKAT®600 data cables are used in the tertiary, but also in the secondary level of a network. They are characterized by large performance reserves and outstanding performance. They can be used to implement services such as Gigabit Ethernet, Fast Ethernet, Ethernet, ATM155, FDDI, token ring 4/16 Mbit/s, or ISDN absolutely trouble-free. Likewise, the mechanical characteristics are perfectly suited for the application in tight cable channels and platforms due to their optimized construction.

## Part no.

**805179**, U/UTP 4x2xAWG23/1 FRNC (UTP)

Dimensions and specifications may be changed without prior notice.

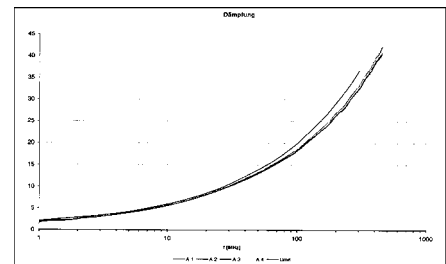



# LAN-Cable

Category 5

**HELUKAT® 100**

U/UTP flex

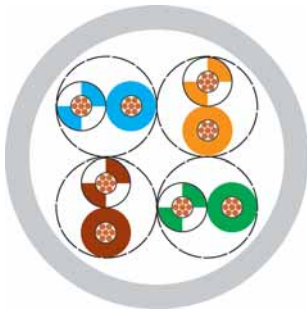

## Cable structure

Inner conductor Ø:	0,48 mm
Conductor material:	Copper, bare
Core insulation:	PO
Core colours:	whbu/bu, whog/og, whgn/gn, whbn/bn
Separator:	-
Screen over stranding element:	-
Screen 1 over stranding:	-
Screen 2 over stranding:	-
Outer sheath material:	PVC
Outer diameter:	app. 4,5 mm
Outer sheath colour:	Grey similar to RAL 7035

## Electrical data

Characteristic impedance:	100 Ohm ± 15 Ohm at 1 to 100 MHz
Loop resistance:	290 Ohm/km max.
Mutual capacitance:	50 nF/km nom.
Rel. propagation velocity:	74 %

## Typical values

Frequency (MHz)	10	16	62,5	100
Attenuation (dB/10m)	0,9	1,2	2,4	3,1
Next (dB)	53,0	50,0	41,0	38,0
ACR (dB)	52,1	48,8	38,6	34,9

## Technical data

Weight:	app. 17 kg/km
bending radius, repeated:	35 mm
Operating temperature range min.:	-20°C
Operating temperature range max.:	+60°C
Caloric load, approx. value:	0,527 MJ/m
Copper weight:	11,00 kg/km

## Norms

Acc. to ISO/IEC 11801, Acc. to EN 50173, Acc. to EIA/TIA 568-A, Category 5

## Application

HELUKAT®100 data cables are used in the tertiary level of a network as patch cables and connection cables. They are characterized by large performance reserves and outstanding performance. They can be used to implement services such as Fast Ethernet, Ethernet, ATM155, FDDI, token ring 4/16 Mbit/s, or ISDN absolutely trouble-free. With its optimized construction, the HELUKAT®100 series can be manufactured quickly and easily with all common RJ45 plugs.

## Part no.

**80055**, U/UTP 4x2xAWG 26/7 PVC (UTP)

Dimensions and specifications may be changed without prior notice.

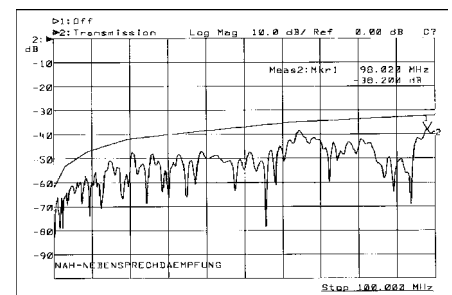
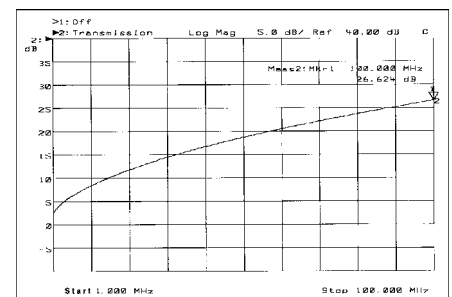

# LAN-Cable

Category 6

**HELUKAT® 300**

U/UTP flex

NEW

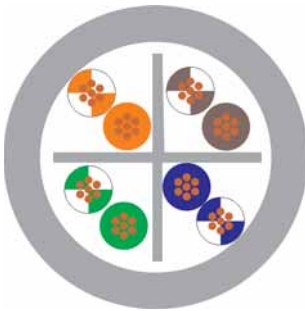

## Cable structure

Inner conductor Ø:  
Conductor material:  
Core insulation:  
Core colours:  
Separator:  
Screen over stranding element:  
Screen 1 over stranding:  
Screen 2 over stranding:  
Outer sheath material:  
Outer diameter:  
Outer sheath colour:

## U/UTP 4x2xAWG 24/ 1 FRNC

0,61 mm  
Copper, bare  
PE  
whbu/bu, whog/og, whgn/gn, whbn/bn  
Polyester foil over stranded bundle  
-  
-  
FRNC  
app. 6,0 mm  
Grey similar to RAL 7035

## Electrical data

Characteristic impedance:  
Loop resistance:  
Mutual capacitance:  
Rel. propagation velocity:

100 Ohm ± 15 Ohm at 1 to 100 MHz  
100 Ohm ± 20 Ohm at 101 to 300 MHz  
180 Ohm/km max.  
50 nF/km nom.  
67 %

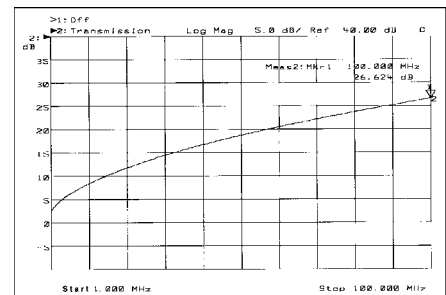

## Typical values

Frequency (MHz)	10	16	62,5	100	155	200	300
Attenuation (dB/10m)	0,8	1,0	2,0	2,6	3,3	3,7	4,7
Next (dB)	75,0	71,0	65,0	63,0	60,0	57,0	56,0
ACR (dB)	74,2	70,0	63,0	60,4	56,7	53,2	51,3

## Technical data

Weight: app. 38 kg/km  
bending radius, repeated: 50 mm  
Operating temperature range min.: -20°C  
Operating temperature range max.: +60°C  
Caloric load, approx. value: 0,11 MJ/m  
Copper weight: 19,00 kg/km

## Norms

Acc. to ISO/IEC 11801, Acc. to EN 50173, Acc. to EIA/TIA 568-A, Category 6, Flame-retardant acc. to IEC 60332-1-2, Smoke density acc. to IEC 61034, Halogen-free acc. to 60754-2, Corrosiveness acc. to EN50267-2-3

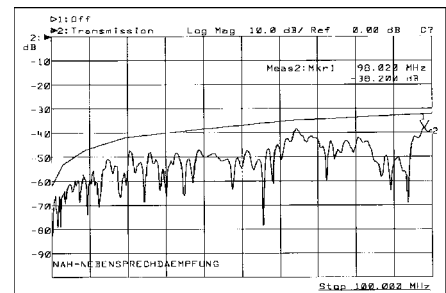

## Application

HELUKAT®300 unshielded data cables are used in the tertiary, but also in the secondary level of a network. They are characterized by large performance reserves and outstanding performance. They can be used to implement services such as Gigabit Ethernet, Fast Ethernet, Ethernet, ATM155, FDDI, token ring 4/16 Mbit/s, or ISDN absolutely trouble-free. With its optimized construction, the HELUKAT®300 series can be manufactured quickly and easily with many common RJ45 plugs.

## Part no.

**804996**, U/UTP 4x2xAWG 24/7 FRNC (UTP)

Dimensions and specifications may be changed without prior notice.

# LAN-Cable, Outdoor

Category 6

**HELUKAT®** 300A

U/UTP



NEW

## Cable structure

Inner conductor Ø:	0,55 mm
Conductor material:	Copper, bare
Core insulation:	PE
Core colours:	whbu/bu, whog/og, whgn/gn, whbn/bn
Separator:	Polyester foil over stranded bundle
Screen over stranding element:	-
Screen 1 over stranding:	-
Screen 2 over stranding:	-
Outer sheath material:	PE
Outer diameter:	app. 6,4 mm
Outer sheath colour:	Black similar to RAL 9005

## U/UTP 4x2xAWG 24/ 1 PE

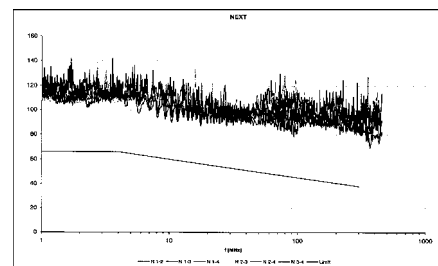

## Electrical data

Characteristic impedance:	100 Ohm ± 15 Ohm at 1 to 100 MHz 100 Ohm ± 20 Ohm at 101 to 300 MHz
Loop resistance:	190 Ohm/km max.
Mutual capacitance:	50 nF/km nom.
Rel. propagation velocity:	67 %

## Typical values

Frequency (MHz)	10	16	62,5	100	155	200	300
Attenuation (dB/100m)	5,6	7,0	14,3	18,2	22,9	26,0	32,5
Next (dB)	72,0	70,0	65,0	63,0	60,0	57,0	55,0
ACR (dB)	66,4	63,0	50,7	44,8	37,1	31,0	22,5

## Technical data

Weight:	app. 47 kg/km
bending radius, repeated:	52 mm
Operating temperature range min.:	-20°C
Operating temperature range max.:	+60°C
Caloric load, approx. value:	0,30 MJ/m
Copper weight:	19,00 kg/km

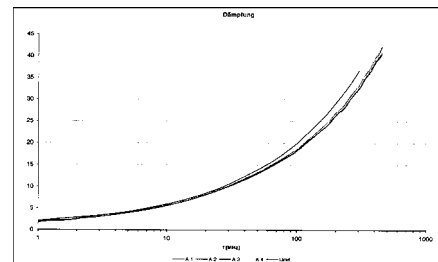

## Norms

Acc. to ISO/IEC 11801, Acc. to EN 50173, Acc. to EIA/TIA 568-A, Category 6, Halogen-free acc. to 60754-2

## Application

HELUKAT® 300A outdoor data cables are used in the tertiary level of a network. They are characterized by large performance reserves and outstanding performance. They can be used to implement services such as Gigabit Ethernet, Fast Ethernet, Ethernet, ATM155, FDDI, token ring 4/16 Mbit/s, or ISDN absolutely trouble-free. Likewise, the mechanical characteristics are perfectly suited for the application in ducts or along buildings due to their optimized construction.

## Part no.

**805683**, U/UTP 4x2xAWG24/1 PE (UTP)

Dimensions and specifications may be changed without prior notice.

# LAN Cable

Category 5e

**HELUKAT® 155**

F/UTP

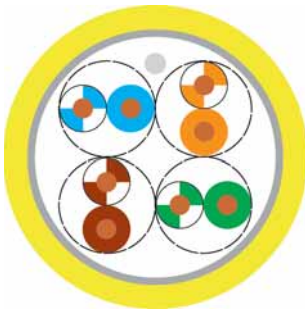

## Cable structure

Inner conductor Ø:	0,51 mm
Conductor material:	Copper, bare
Core insulation:	PE
Core colours:	whbu/bu, whog/og, whgn/gn, whbn/bn
Separator:	Polyester foil over stranded bundle
Screen over stranding element:	-
Screen 1 over stranding:	Al-Foil
Screen 2 over stranding:	-
Drain wire:	yes
Outer sheath material:	PVC
Outer diameter:	app. 5,9 mm
Outer sheath colour:	Yellow similar to RAL 1021

## F/UTP 4x2xAWG 24/1 PVC

## Electrical data

Characteristic impedance:	100 Ohm ± 15 Ohm at 1 to 100 MHz 100 Ohm ± 20 Ohm at 101 to 155 MHz
Loop resistance:	170 Ohm/km max.
Mutual capacitance:	50 nF/km nom.
Rel. propagation velocity:	69 %

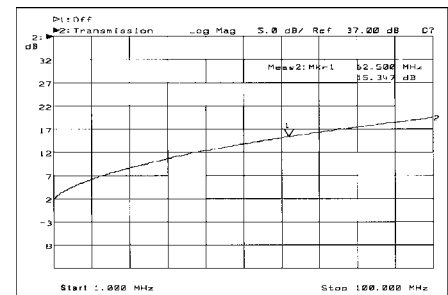

## Typical values

Frequency (MHz)	10	16	62,5	100	155
Attenuation (dB/100m)	5,9	7,6	15,7	20,3	22,0
Next (dB)	59,0	53,0	44,0	40,0	40,0
ACR (dB)	53,1	45,4	28,3	19,7	18,0

## Technical data

Weight:	app. 40 kg/km
bending radius, repeated:	48 mm
Operating temperature range min.:	-20°C
Operating temperature range max.:	+60°C
Caloric load, approx. value:	0,40 MJ/m
Copper weight:	18,00 kg/km

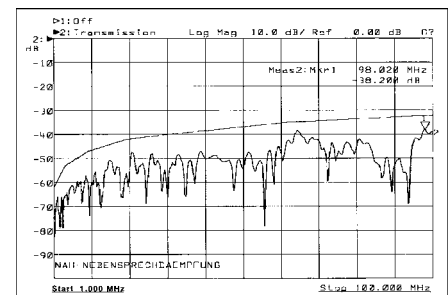

## Norms

Acc. to ISO/IEC 11801, Acc. to EN 50173, Acc. to EIA/TIA 568-A, Category 5e

## Application

HELUKAT®155 data cables are used in the tertiary, but also in the secondary level of a network. They are characterized by large performance reserves and outstanding performance. They can be used to implement services such as Fast Ethernet, Ethernet, ATM155, FDDI, token ring 4/16 Mbit/s, or ISDN absolutely trouble-free. Likewise, the mechanical characteristics are perfectly suited for the application in tight cable channels and platforms due to their optimized construction.

## Part no.

**80043**, F/UTP 4x2xAWG24/1 PVC (FTP)

Dimensions and specifications may be changed without prior notice.

# LAN Cable

Category 5

**HELUKAT® 100**

F/UTP flex

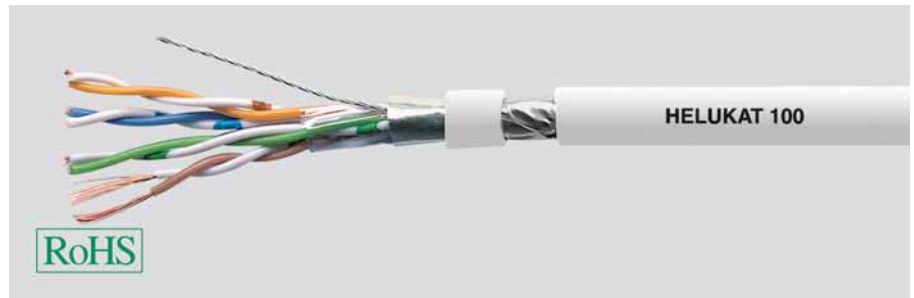
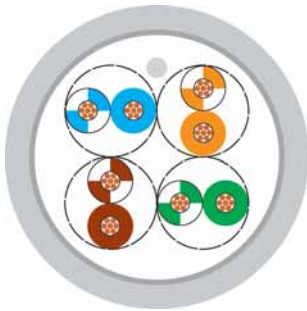

## Cable structure

Inner conductor Ø:	0,48 mm
Conductor material:	Copper, bare
Core insulation:	Foam-skin-PE
Core colours:	whbu/bu, whog/og, whgn/gn, whbn/bn
Separator:	-
Screen over stranding element:	-
Screen 1 over stranding:	Al-Foil
Screen 2 over stranding:	-
Drain wire:	yes
Outer sheath material:	FRNC
Outer diameter:	app. 5,3 mm
Outer sheath colour:	Grey similar to RAL 7035

## F/UTP 4x2xAWG 26/7 FRNC

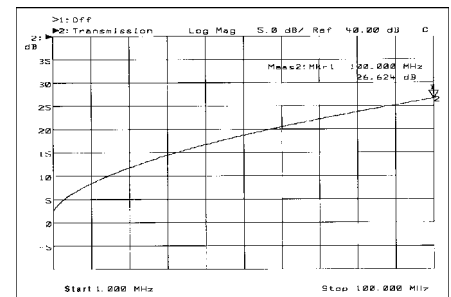

## Electrical data

Characteristic impedance:	100 Ohm ± 15 Ohm at 1 to 100 MHz
Loop resistance:	290 Ohm/km max.
Mutual capacitance:	50 nF/km nom.
Rel. propagation velocity:	74 %

## Typical values

Frequency (MHz)	10	16	62,5	100
Attenuation (dB/10m)	0,9	1,2	2,4	2,9
Next (dB)	58,0	56,0	45,0	43,0
ACR (dB)	57,1	54,8	42,6	40,1

## Technical data

Weight:	app. 31 kg/km
bending radius, repeated:	40 mm
Operating temperature range min.:	-20°C
Operating temperature range max.:	+60°C
Caloric load, approx. value:	0,45 MJ/m
Copper weight:	14,00 kg/km

## Norms

Acc. to ISO/IEC 11801, Acc. to EN 50173, Acc. to EIA/TIA 568-A, Category 5, Flame-retardant acc. to IEC 60332-1-2, Smoke density acc. to IEC 61034, Halogen-free acc. to 60754-2, Corrosiveness acc. to EN50267-2-3

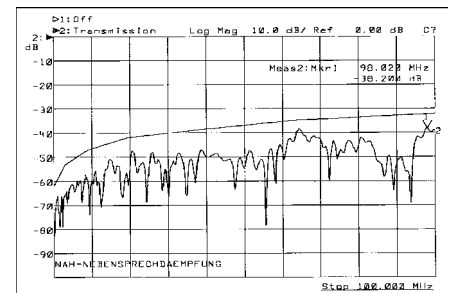

## Application

HELUKAT® 100 data cables are used in the tertiary level of a network as patch cables and connection cables. They are characterized by large performance reserves and outstanding performance. They can be used to implement services such as Fast Ethernet, Ethernet, ATM155, FDDI, token ring 4/16 Mbit/s, or ISDN absolutely trouble-free. With its optimized construction, the HELUKAT® 100 series can be manufactured quickly and easily with all common RJ45 plugs.

## Part no.

**81278**, F/UTP 4x2xAWG 26/7 FRNC (FTP)

Dimensions and specifications may be changed without prior notice.

# LAN Cable

Category 5

**HELUKAT® 100**

F/UTP FE60

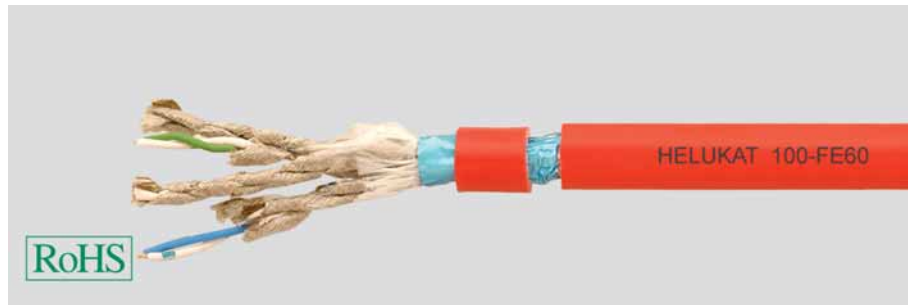

## Cable structure

Inner conductor Ø:	0,57 mm
Conductor material:	Copper, bare
Core insulation:	PO + flame resistant tape
Core colours:	whbu/bu, whog/og, whgn/gn, whbn/bn
Separator:	-
Screen over stranding element:	PO tape
Screen 1 over stranding:	Helical glasfibre tape
Screen 2 over stranding:	Al-Foil
Drain wire:	yes
Outer sheath material:	LSZH
Outer diameter:	app. 8,3 mm
Outer sheath colour:	Red

## F/UTP 4x2xAWG 23/1 FR-0H

## Electrical data

Characteristic impedance:	100 Ohm ± 15 Ohm at 1 to 100 MHz
Loop resistance:	188 Ohm/km max.
Mutual capacitance:	65 nF/km nom.
Rel. propagation velocity:	67 %

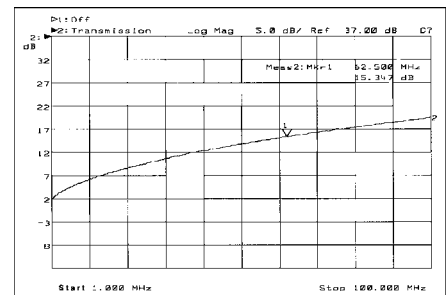

## Typical values

Frequency (MHz)	10	16	62,5	100
Attenuation (dB/100m)	5,9	7,9	16,3	21,1
Next (dB)	58,0	51,0	41,0	38,0
ACR (dB)	52,1	43,1	24,7	16,9

## Technical data

Weight:	app. 75 kg/km
bending radius, repeated:	130 mm
Operating temperature range min.:	-20°C
Operating temperature range max.:	+70°C
Caloric load, approx. value:	0,72 MJ/m
Copper weight:	24,00 kg/km

## Norms

Acc. to ISO/IEC 11801, Acc. to EN 50173, Acc. to EIA/TIA 568-A, Category 5, Flame-retardant acc. to IEC 60332-3, Smoke density acc. to IEC 61034, Halogen-free acc. to 60754-2, Corrosiveness acc. to EN50267-2-3

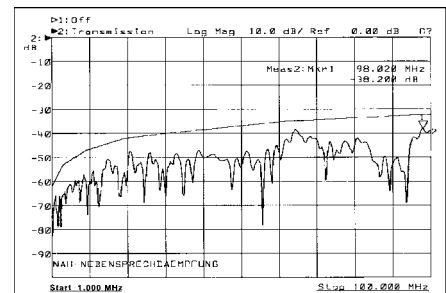

## Application

HELUKAT®100-FE60 data cables are used in the tertiary, but also in the secondary level of a network. They are characterized by large performance reserves and outstanding performance. They can be used to implement services such as Fast Ethernet, Ethernet, ATM155, FDDI, token ring 4/16 Mbit/s, or ISDN absolutely trouble-free. Likewise, the thermal characteristics are perfectly suited to realize an isolation integrity according EN50200-FE60 due to their optimized construction.

## Part no.

**804045**, F/UTP 4x2xAWG23/1 FRNC

Dimensions and specifications may be changed without prior notice.

# LAN Cable

Category 5e

**HELUKAT® 200**

F/UTP Flex, UL

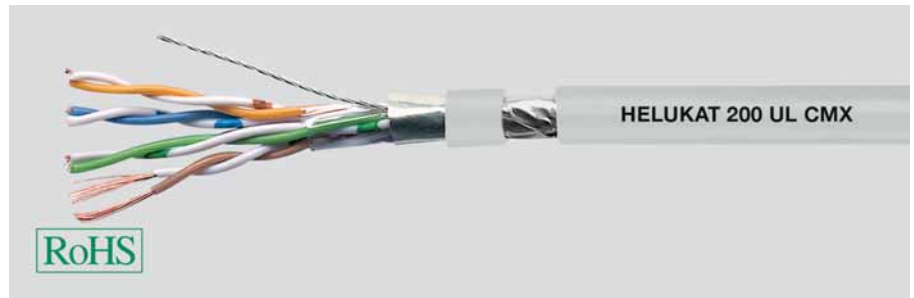
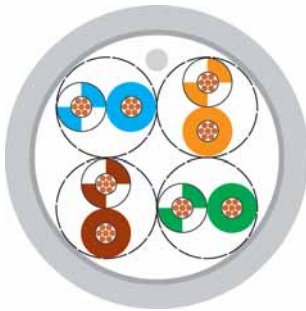

## Cable structure

Inner conductor Ø:	0,48 mm
Conductor material:	Copper, bare
Core insulation:	PE
Core colours:	whbu/bu, whog/og, whgn/gn, whbn/bn
Separator:	-
Screen over stranding element:	-
Screen 1 over stranding:	Al-Foil
Screen 2 over stranding:	-
Drain wire:	yes
Outer sheath material:	PVC
Outer diameter:	app. 5,4 mm
Outer sheath colour:	Grey similar to RAL 7035

## F/UTP 4x2xAWG 26/7 PVC, UL

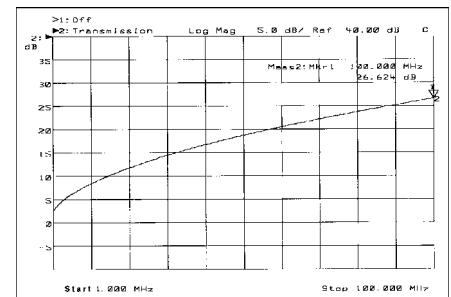

## Electrical data

Characteristic impedance:	100 Ohm ± 15 Ohm at 1 to 100 MHz 100 Ohm ± 20 Ohm at 101 to 200 MHz
Loop resistance:	290 Ohm/km max.
Mutual capacitance:	50 nF/km nom.
Rel. propagation velocity:	67 %

## Typical values

Frequency (MHz)	10	16	62,5	100	200
Attenuation (dB/10m)	0,9	1,2	2,4	3,1	3,9
Next (dB)	62,0	60,0	50,0	48,0	45,0
ACR (dB)	61,1	58,8	47,6	44,9	41,1

## Technical data

Weight:	app. 30 kg/km
bending radius, repeated:	44 mm
Operating temperature range min.:	-20°C
Operating temperature range max.:	+60°C
Caloric load, approx. value:	0,40 MJ/m
Copper weight:	15,00 kg/km

## Norms

Acc. to ISO/IEC 11801, Acc. to EN 50173, Acc. to EIA/TIA 568-A, Category 5e, Flame-retardant acc. to IEC 60332-1-2, Smoke density acc. to IEC 61034, CMX 444

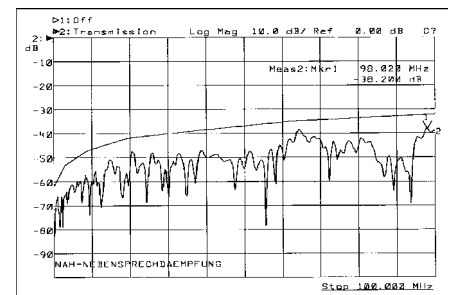

## Application

HELUKAT®200 data cables are used in the tertiary level of a network as patch cables and connection cables. They are characterized by large performance reserves and outstanding performance. They can be used to implement services such as Gigabit Ethernet, Fast Ethernet, Ethernet, ATM155, FDDI, token ring 4/16 Mbit/s, or ISDN absolutely trouble-free. With its optimized construction, the HELUKAT®200 series can be manufactured quickly and easily with all common RJ45 plugs. This type is certified according to UL because of the special PVC jacket.

## Part no.

**802173**, F/UTP 4x2xAWG26/7 PVC UL (FTP)

Dimensions and specifications may be changed without prior notice.

# LAN-Cable, Outdoor

Category 5e

**HELUKAT® 200A**

F/UTP

NEW

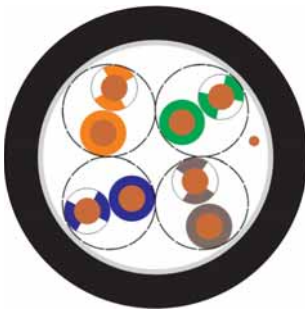

## Cable structure

Inner conductor Ø: 0,55 mm  
 Conductor material: Copper, bare  
 Core insulation: PE  
 Core colours: whbu/bu, whog/og, whgn/gn, whbn/bn  
 Separator: -  
 Screen over stranding element: Al-Foil  
 Screen 1 over stranding: -  
 Screen 2 over stranding: -  
 Drain wire: yes  
 Outer sheath material: PE  
 Outer diameter: app. 8,0 mm  
 Outer sheath colour: Black similar to RAL 9005

## F/UTP 4x2xAWG 24/1 PE

## Electrical data

Characteristic impedance: 100 Ohm ± 15 Ohm at 1 to 100 MHz  
 100 Ohm ± 20 Ohm at 101 to 200 MHz  
 Loop resistance: 190 Ohm/km max.  
 Mutual capacitance: 45 nF/km nom.  
 Rel. propagation velocity: 67 %

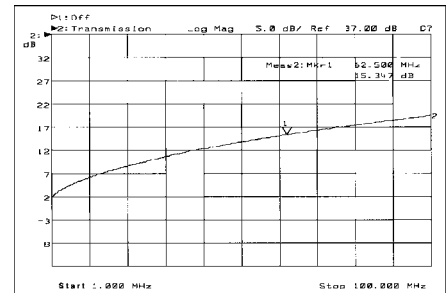

## Typical values

Frequency (MHz)	10	16	62,5	100	155	200
Attenuation (dB/100m)	5,6	7,2	14,4	18,2	22,9	24,2
Next (dB)	70,0	68,0	56,0	50,0	45,0	42,0
ACR (dB)	64,4	60,8	41,6	31,8	22,1	17,8

## Technical data

Weight: app. 100 kg/km  
 bending radius, repeated: 65 mm  
 Operating temperature range min.: -30°C  
 Operating temperature range max.: +70°C  
 Copper weight: 18,00 kg/km

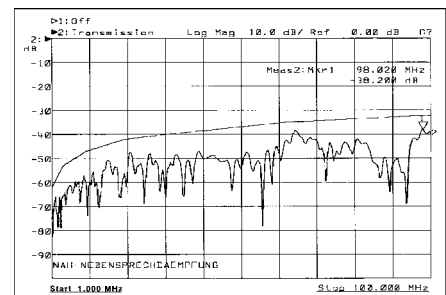

## Norms

Acc. to ISO/IEC 11801, Acc. to EN 50173, Acc. to EIA/TIA 568-A, Category 5e, Halogen-free acc. to 60754-2

## Application

HELUKAT® 200A outdoor data cables are used in the tertiary level of a network. They are characterized by large performance reserves and outstanding performance. They can be used to implement services such as Gigabit Ethernet, Fast Ethernet, Ethernet, ATM155, FDDI, token ring 4/16 Mbit/s, or ISDN absolutely trouble-free. Likewise, the mechanical characteristics are perfectly suited for the application in ducts or along buildings due to their optimized construction.

## Part no.

**805572**, F/UTP 4x2xAWG 24/1 PE (FTP)

Dimensions and specifications may be changed without prior notice.



# LAN Cable

Category 5e

**HELUKAT® 200**  
SF/UTP

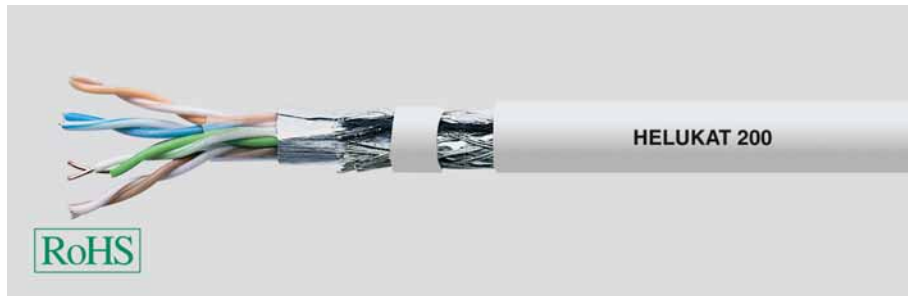
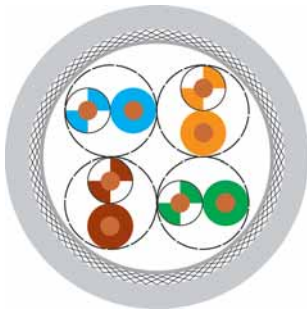

## Cable structure

Inner conductor Ø: 0,51 mm  
 Conductor material: Copper, bare  
 Core insulation: Foam-skin-PE  
 Core colours: whbu/bu, whog/og, whgn/gn, whbn/bn  
 Separator: -  
 Screen over stranding element: -  
 Screen 1 over stranding: Al-Foil  
 Screen 2 over stranding: Cu braid  
 Outer sheath material: PVC / FRNC  
 Outer diameter: app. 6,0 mm / app. 6,0 mm  
 Outer sheath colour: Grey similar to RAL 7035

## SF/UTP 4x2xAWG 24/1 PVC

## Electrical data

Characteristic impedance: 100 Ohm ± 15 Ohm at 1 to 100 MHz  
 100 Ohm ± 20 Ohm at 101 to 200 MHz  
 Loop resistance: 185 Ohm/km max.  
 Mutual capacitance: 48 nF/km nom.  
 Rel. propagation velocity: 74 %

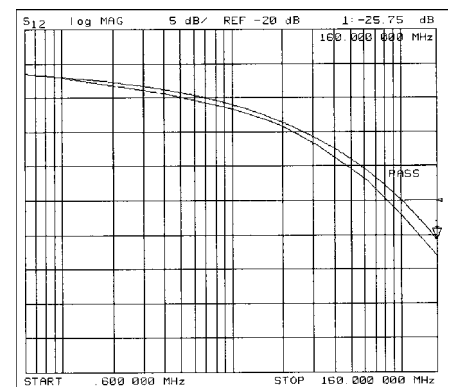

## Typical values

Frequency (MHz)	10	16	62,5	100	200
Attenuation (dB/100m)	5,6	7,2	14,4	18,2	25,9
Next (dB)	62,0	59,0	50,0	46,0	40,0
ACR (dB)	56,4	51,8	35,6	27,8	14,6

## Technical data

Weight: app. 50 kg/km  
 bending radius, repeated: 52 mm  
 Operating temperature range min.: -20°C  
 Operating temperature range max.: +60°C  
 Caloric load, approx. value: 0,60 MJ/m / 0,48 MJ/m  
 Copper weight: 28,00 kg/km

## Norms

81610:  
 Acc. to ISO/IEC 11801, Acc. to EN 50173, Acc. to EIA/TIA 568-A, Category 5e  
 81609:  
 Acc. to ISO/IEC 11801, Acc. to EN 50173, Acc. to EIA/TIA 568-A, Category 5e, Flame-retardant:  
 acc. to IEC 60332-3, Smoke density acc. to IEC 61034, Halogen-free acc. to 60754-2, Corrosiveness  
 acc. to EN50267-2-3

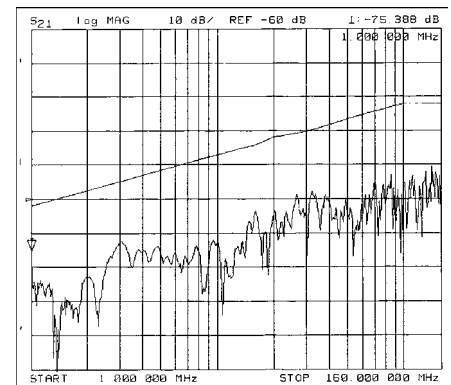

## Application

HELUKAT®200 data cables are used in the tertiary, but also in the secondary level of a network. They are characterized by large performance reserves and outstanding performance. They can be used to implement services such as Gigabit Ethernet, Fast Ethernet, Ethernet, ATM155, FDDI, token ring 4/16 Mbit/s, or ISDN absolutely trouble-free. Likewise, the mechanical characteristics are perfectly suited for the application in tight cable channels and platforms due to their optimized construction.

## Part no.

**81610**, SF/UTP 4x2xAWG 24/1 PVC (S-FTP)

**81609**, SF/UTP 4x2xAWG 24/1 FRNC (S-FTP)

Dimensions and specifications may be changed without prior notice.

# LAN Cable

Category 5e

**HELUKAT® 200**

SF/UTP duplex

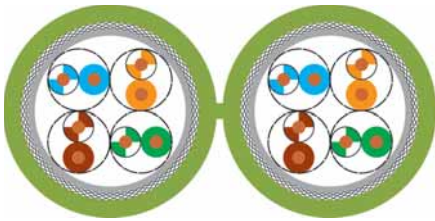

## Cable structure

Inner conductor Ø: 0,51 mm  
 Conductor material: Copper, bare  
 Core insulation: Foam-skin-PE  
 Core colours: whbu/bu, whog/og, whgn/gn, whbn/bn  
 Separator: -  
 Screen over stranding element: -  
 Screen 1 over stranding: Al-Foil  
 Screen 2 over stranding: Cu braid  
 Outer sheath material: FRNC  
 Cable dimensions: app. 6,0 mm x 12,5 mm  
 Outer sheath colour: Green similar to RAL 6018

## SF/UTP 2x(4x2xAWG 24/1) FRNC

## Electrical data

Characteristic impedance: 100 Ohm ± 15 Ohm at 1 to 100 MHz  
 100 Ohm ± 20 Ohm at 101 to 200 MHz  
 Loop resistance: 185 Ohm/km max.  
 Mutual capacitance: 48 nF/km nom.  
 Rel. propagation velocity: 74 %

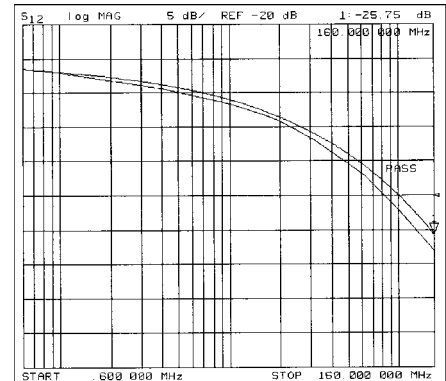

## Typical values

Frequency (MHz)	10	16	62,5	100	200
Attenuation (dB/100m)	5,6	7,2	14,4	18,2	25,9
Next (dB)	62,0	59,0	50,0	46,0	40,0
ACR (dB)	56,4	51,8	35,6	27,8	14,6

## Technical data

Weight: app. 100 kg/km  
 bending radius, repeated: 52 mm  
 Operating temperature range min.: -20°C  
 Operating temperature range max.: +60°C  
 Caloric load, approx. value: 0,96 MJ/m  
 Copper weight: 56,00 kg/km

## Norms

Acc. to ISO/IEC 11801, Acc. to EN 50173, Acc. to EIA/TIA 568-A, Category 5e, Flame-retardant acc. to IEC 60332-3, Smoke density acc. to IEC 61034, Halogen-free acc. to 60754-2, Corrosiveness acc. to EN50267-2-3

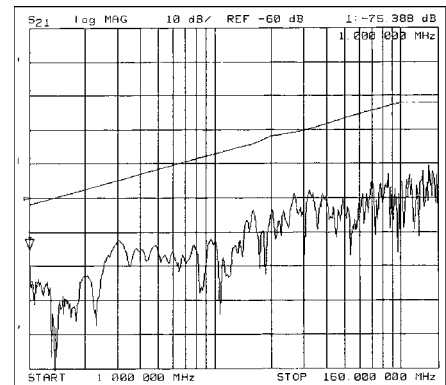

## Application

HELUKAT®200 data cables are used in the tertiary, but also in the secondary level of a network. They are characterized by large performance reserves and outstanding performance. They can be used to implement services such as Gigabit Ethernet, Fast Ethernet, Ethernet, ATM155, FDDI, token ring 4/16 Mbit/s, or ISDN absolutely trouble-free. Likewise, the mechanical characteristics are perfectly suited for the application in tight cable channels and platforms due to their optimized construction.

## Part no.

**81123**, SF/UTP 2x(4x2xAWG 24/1) FRNC (S-FTP)

Dimensions and specifications may be changed without prior notice.

# LAN Cable

Category 5e

**HELUKAT® 200**

SF/UTP flex

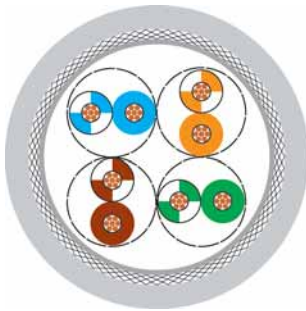

## Cable structure

Inner conductor Ø:	0,48 mm
Conductor material:	Copper, bare
Core insulation:	Foam-skin-PE
Core colours:	whbu/bu, whog/og, whgn/gn, whbn/bn
Separator:	-
Screen over stranding element:	-
Screen 1 over stranding:	Al-Foil
Screen 2 over stranding:	Cu braid
Outer sheath material:	FRNC
Outer diameter:	app. 5,4 mm
Outer sheath colour:	Grey similar to RAL 7035

## SF/UTP 4x2xAWG 26/7 FRNC

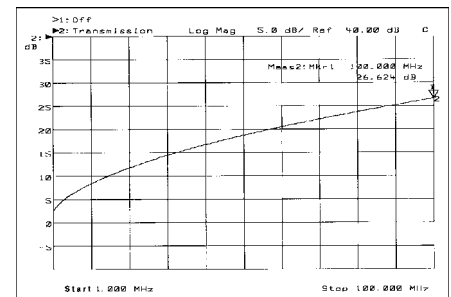

## Electrical data

Characteristic impedance:	100 Ohm ± 15 Ohm at 1 to 100 MHz 100 Ohm ± 20 Ohm at 101 to 200 MHz
Loop resistance:	300 Ohm/km max.
Mutual capacitance:	47 nF/km nom.
Rel. propagation velocity:	69 %

## Typical values

Frequency (MHz)	10	16	62,5	100	200
Attenuation (dB/10m)	0,8	1,1	2,4	2,9	4,3
Next (dB)	58,0	56,0	45,0	43,0	37,0
ACR (dB)	57,2	54,9	42,6	40,1	32,7

## Technical data

Weight:	app. 40 kg/km
bending radius, repeated:	46 mm
Operating temperature range min.:	-20°C
Operating temperature range max.:	+60°C
Caloric load, approx. value:	0,543 MJ/m
Copper weight:	24,00 kg/km

## Norms

Acc. to ISO/IEC 11801, Acc. to EN 50173, Acc. to EIA/TIA 568-A, Category 5e, Flame-retardant acc. to IEC 60332-1-2, Smoke density acc. to IEC 61034, Halogen-free acc. to 60754-2, Corrosiveness acc. to EN50267-2-3

## Application

HELUKAT®200 data cables are used in the tertiary level of a network as patch cables and connection cables. They are characterized by large performance reserves and outstanding performance. They can be used to implement services such as Gigabit Ethernet, Fast Ethernet, Ethernet, ATM155, FDDI, token ring 4/16 Mbit/s, or ISDN absolutely trouble-free. With its optimized construction, the HELUKAT®200 series can be manufactured quickly and easily with all common RJ45 plugs.

## Part no.

**81254**, SF/UTP 4x2xAWG 26/7 FRNC (S-FTP)

Dimensions and specifications may be changed without prior notice.

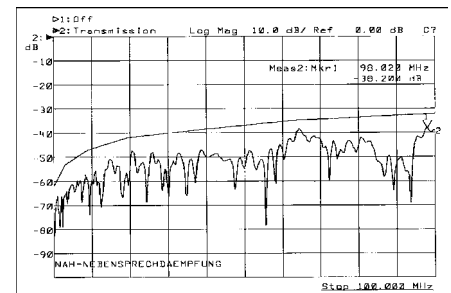

# LAN Cable

Category 6

**HELUKAT® 300**

U/FTP, UL

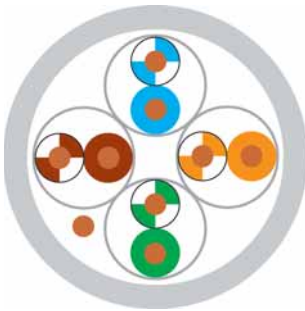

## Cable structure

Inner conductor Ø: 0,48 mm  
 Conductor material: Copper, bare  
 Core insulation: Foam-skin-PE  
 Core colours: whbu/bu, whog/og, whgn/gn, whbn/bn  
 Separator: Polyester foil over stranded bundle  
 Screen over stranding element: Al-Foil  
 Screen 1 over stranding: -  
 Screen 2 over stranding: -  
 Drain wire: yes  
 Outer sheath material: PVC  
 Outer diameter: app. 5,9 mm  
 Outer sheath colour: Grey similar to RAL 7035

## U/FTP 4x2xAWG 26/7 PVC, UL

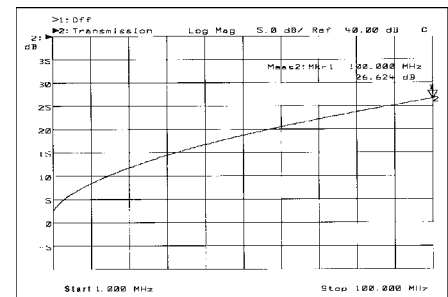

## Electrical data

Characteristic impedance: 100 Ohm ± 15 Ohm at 1 to 100 MHz  
 100 Ohm ± 20 Ohm at 101 to 300 MHz  
 Loop resistance: 290 Ohm/km max.  
 Mutual capacitance: 45 nF/km nom.  
 Rel. propagation velocity: 77 %

## Typical values

Frequency (MHz)	10	16	62,5	100	200	300
Attenuation (dB/10m)	0,9	1,1	2,2	2,7	3,9	4,7
Next (dB)	90,0	88,0	83,0	80,0	76,0	73,0
ACR (dB)	89,1	86,9	80,8	77,3	72,1	68,3

## Technical data

Weight: app. 37 kg/km  
 bending radius, repeated: 48 mm  
 Operating temperature range min.: -20°C  
 Operating temperature range max.: +60°C  
 Caloric load, approx. value: 0,41 MJ/m  
 Copper weight: 20,00 kg/km

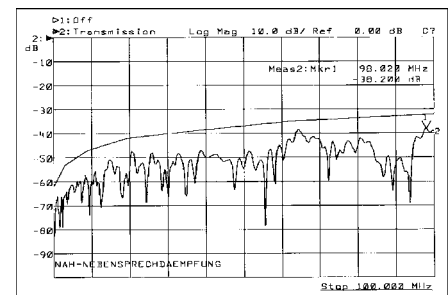

## Norms

Acc. to ISO/IEC 11801, Acc. to EN 50173, Acc. to EIA/TIA 568-A, Category 6, Flame-retardant acc. to IEC 60332-1-2, Smoke density acc. to IEC 61034, CMX 444

## Application

HELUKAT®300 data cables are used in the tertiary level of a network as patch cables and connection cables. They are characterized by large performance reserves and outstanding performance. They can be used to implement services such as Gigabit Ethernet, Fast Ethernet, Ethernet, ATM155, FDDI, token ring 4/16 Mbit/s, or ISDN absolutely trouble-free. With its optimized construction, the HELUKAT®300 series can be manufactured quickly and easily with all common RJ45 plugs. This type is certified according to UL because of the special PVC jacket.

## Part no.

**802174**, U/FTP 4x2xAWG 26/7 PVC

Dimensions and specifications may be changed without prior notice.

# LAN Cable

Category 6

**HELUKAT® 450**

F/FTP

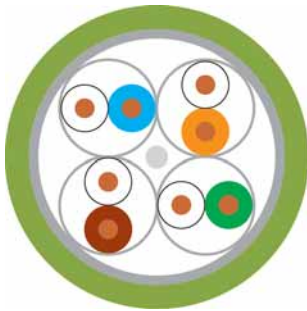

## Cable structure

Inner conductor Ø: 0,52 mm  
 Conductor material: Copper, bare  
 Core insulation: Foam-skin-PE  
 Core colours: wh/bu, wh/og, wh/gn, wh/bn  
 Separator: -  
 Screen over stranding element: Al-Foil  
 Screen 1 over stranding: Al-Foil  
 Screen 2 over stranding: -  
 Drain wire: yes  
 Outer sheath material: FRNC  
 Outer diameter: app. 7,4 mm  
 Outer sheath colour: Green similar to RAL 6018

## F/FTP 4x2xAWG 24/1 FRNC

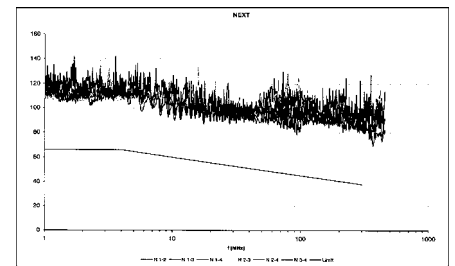

## Electrical data

Characteristic impedance: 100 Ohm ± 15 Ohm at 1 to 100 MHz  
 100 Ohm ± 20 Ohm at 101 to 450 MHz  
 Loop resistance: 165 Ohm/km max.  
 Mutual capacitance: 43 nF/km nom.  
 Rel. propagation velocity: 79 %

## Typical values

Frequency (MHz)	10	16	62,5	100	200	300	450
Attenuation (dB/100m)	5,4	7,0	13,8	17,6	26,0	34,0	38,5
Next (dB)	100,0	100,0	95,8	94,5	91,0	87,0	84,3
ACR (dB)	94,6	93,0	82,0	76,9	65,0	53,0	45,8

## Technical data

Weight: app. 50 kg/km  
 bending radius, repeated: 59 mm  
 Operating temperature range min.: -20°C  
 Operating temperature range max.: +60°C  
 Caloric load, approx. value: 0,57 MJ/m  
 Copper weight: 24,00 kg/km

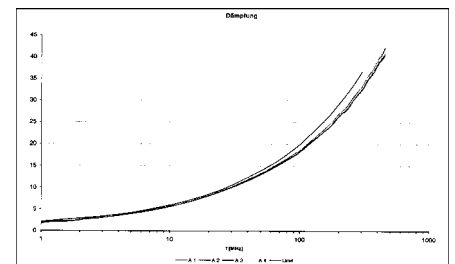

## Norms

Acc. to ISO/IEC 11801, Acc. to EN 50173, Acc. to EIA/TIA 568-A, Category 6, Flame-retardant acc. to IEC 60332-3, Smoke density acc. to IEC 61034, Halogen-free acc. to 60754-2, Corrosiveness acc. to EN50267-2-3

## Application

HELUKAT®450 data cables are used in the tertiary, but also in the secondary level of a network. They are characterized by large performance reserves and outstanding performance. They can be used to implement services such as Gigabit Ethernet, Fast Ethernet, Ethernet, ATM155, FDDI, token ring 4/16 Mbit/s or ISDN absolutely trouble-free. Likewise, the mechanical characteristics are perfectly suited for the application in tight cable channels and platforms due to their optimized construction.

## Part no.

**82501**, F/FTP 4x2xAWG 24/1 FRNC (S-STP)

Dimensions and specifications may be changed without prior notice.

# LAN Cable

Category 6

**HELUKAT® 450**

F/FTP duplex



## Cable structure

Inner conductor Ø:  
Conductor material:  
Core insulation:  
Core colours:  
Separator:  
Screen over stranding element:  
Screen 1 over stranding:  
Screen 2 over stranding:  
Drain wire:  
Outer sheath material:  
Cable dimensions:  
Outer sheath colour:

## F/FTP 2x(4x2xAWG 24/1) FRNC

0,52 mm  
Copper, bare  
Foam-skin-PE  
wh/bu, wh/og, wh/gn, wh/bn  
-  
Al-Foil  
Al-Foil  
-  
yes  
FRNC  
app. 7,4 mm x 15,0 mm  
Green similar to RAL 6018

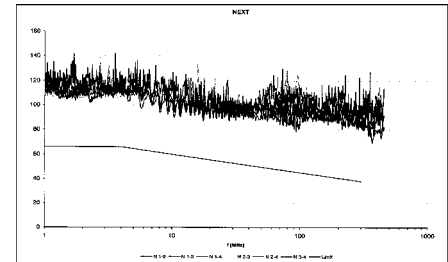

## Electrical data

Characteristic impedance: 100 Ohm ± 15 Ohm at 1 to 100 MHz  
100 Ohm ± 20 Ohm at 101 to 450 MHz  
Loop resistance: 165 Ohm/km max.  
Mutual capacitance: 43 nF/km nom.  
Rel. propagation velocity: 79 %

## Typical values

Frequency (MHz)	10	16	62,5	100	200	300	450
Attenuation (dB/100m)	5,4	7,0	13,8	17,6	26,0	34,0	38,5
Next (dB)	100,0	100,0	95,8	94,5	91,0	87,0	84,3
ACR (dB)	94,6	93,0	82,0	76,9	65,0	53,0	45,8

## Technical data

Weight: app. 100 kg/km  
bending radius, repeated: 59 mm  
Operating temperature range min.: -20°C  
Operating temperature range max.: +60°C  
Caloric load, approx. value: 1,14 MJ/m  
Copper weight: 48,00 kg/km

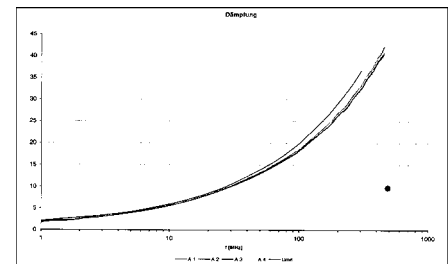

## Norms

Acc. to ISO/IEC 11801, Acc. to EN 50173, Acc. to EIA/TIA 568-A, Category 6, Flame-retardant acc. to IEC 60332-3, Smoke density acc. to IEC 61034, Halogen-free acc. to 60754-2, Corrosiveness acc. to EN50267-2-3

## Application

HELUKAT®450 data cables are used in the tertiary, but also in the secondary level of a network. They are characterized by large performance reserves and outstanding performance. They can be used to implement services such as Gigabit Ethernet, Fast Ethernet, Ethernet, ATM155, FDDI, token ring 4/16 Mbit/s or ISDN absolutely trouble-free. Likewise, the mechanical characteristics are perfectly suited for the application in tight cable channels and platforms due to their optimized construction.

## Part no.

**82502**, F/FTP 2x4x2xAWG 24/1 FRNC (S-STP)

Dimensions and specifications may be changed without prior notice.

# LAN Cable

Category 6A

**HELUKAT® 500**  
F/FTP

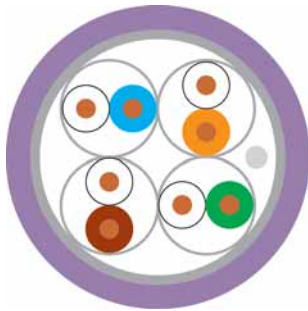

## Cable structure

Inner conductor Ø: 0,57 mm  
 Conductor material: Copper, bare  
 Core insulation: Foam-skin-PE  
 Core colours: wh/bu, wh/og, wh/gn, wh/bn  
 Separator: -  
 Screen over stranding element: Al-Foil  
 Screen 1 over stranding: Al-Foil  
 Screen 2 over stranding: -  
 Drain wire: yes  
 Outer sheath material: LSZH  
 Outer diameter: app. 7,5 mm  
 Outer sheath colour: Blue Lilac similar to RAL 4005

## F/FTP 4x2xAWG 23/1 LSZH

## Electrical data

Characteristic impedance: 100 Ohm ± 15 Ohm at 1 to 100 MHz  
 100 Ohm ± 20 Ohm at 101 to 500 MHz  
 Loop resistance: 160 Ohm/km max.  
 Mutual capacitance: 45 nF/km nom.  
 Rel. propagation velocity: 80 %

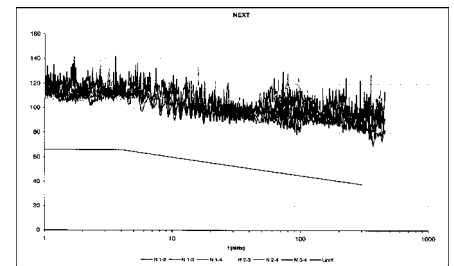

## Typical values

Frequency (MHz)	10	16	62,5	100	200	250	300	500
Attenuation (dB/100m)	5,7	7,2	14,2	18,1	25,8	29,0	31,9	41,8
Next (dB)	100,0	100,0	100,0	97,4	92,9	91,4	90,2	86,9
ACR (dB)	94,3	92,8	85,8	79,3	67,1	62,4	58,3	45,1

## Technical data

Weight: app. 50 kg/km  
 bending radius, repeated: 100 mm  
 Operating temperature range min.: -20°C  
 Operating temperature range max.: +60°C  
 Caloric load, approx. value: 0,55 MJ/m  
 Copper weight: 26,00 kg/km

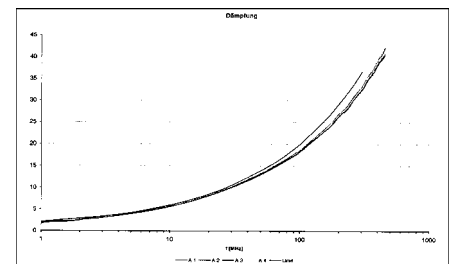

## Norms

Acc. to ISO/IEC 11801, Acc. to EN 50173, Acc. to EIA/TIA 568-A, Category 6A, Flame-retardant acc. to IEC 60332-3, Smoke density acc. to IEC 61034, Halogen-free acc. to 60754-2, Corrosiveness acc. to EN50267-2-3

## Application

HELUKAT® 500 data cables are used in the tertiary, but also in the secondary level of a network. They are characterized by large performance reserves and outstanding performance. They can be used to implement services such as 10Gigabit Ethernet, Gigabit Ethernet, Fast Ethernet, Ethernet, ATM155, FDDI, token ring 4/16 Mbit/s or ISDN absolutely trouble-free. Likewise, the mechanical characteristics are perfectly suited for the application in tight cable channels and platforms due to their optimized construction.

## Part no.

**803378**, F/FTP 4x2xAWG 23/1 LSZH (S-STP)

Dimensions and specifications may be changed without prior notice.

# LAN Cable

Category 6A

**HELUKAT® 500**

F/FTP duplex

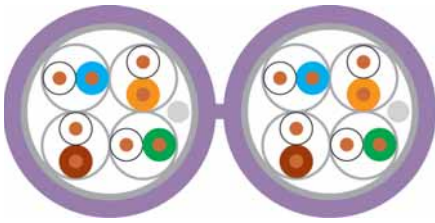

## Cable structure

Inner conductor Ø: 0,57 mm  
Conductor material: Copper, bare  
Core insulation: Foam-skin-PE  
Core colours: wh/bu, wh/og, wh/gn, wh/bn  
Separator: -  
Screen over stranding element: Al-Foil  
Screen 1 over stranding: Al-Foil  
Screen 2 over stranding: -  
Drain wire: yes  
Outer sheath material: LSZH  
Cable dimensions: app. 7,8 mm x 15,9 mm  
Outer sheath colour: Blue Lilac similar to RAL 4005

## F/FTP 2x(4x2xAWG 23/1) LSZH (S-STP)

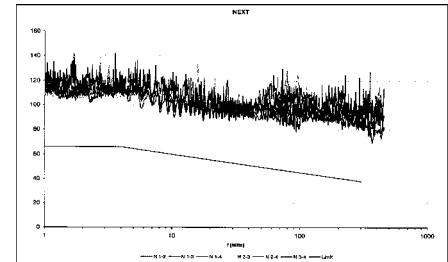

## Electrical data

Characteristic impedance: 100 Ohm ± 15 Ohm at 1 to 100 MHz  
100 Ohm ± 20 Ohm at 101 to 500 MHz  
Loop resistance: 160 Ohm/km max.  
Mutual capacitance: 45 nF/km nom.  
Rel. propagation velocity: 80 %

## Typical values

Frequency (MHz)	10	16	62,5	100	200	250	300	500
Attenuation (dB/100m)	5,7	7,2	14,2	18,1	25,8	29,0	31,9	41,8
Next (dB)	100,0	100,0	100,0	97,4	92,9	91,4	90,2	86,9
ACR (dB)	94,3	92,8	85,8	79,3	67,1	62,4	58,3	45,1

## Technical data

Weight: app. 100 kg/km  
bending radius, repeated: 100 mm  
Operating temperature range min.: -20°C  
Operating temperature range max.: +60°C  
Caloric load, approx. value: 1,13 MJ/m  
Copper weight: 52,00 kg/km

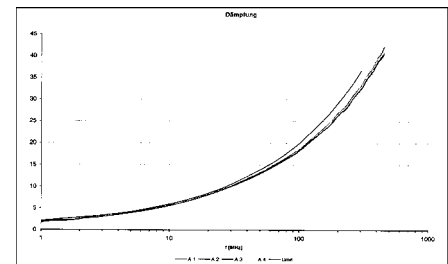

## Norms

Acc. to ISO/IEC 11801, Acc. to EN 50173, Acc. to EIA/TIA 568-A, Category 6A, Flame-retardant acc. to IEC 60332-3, Smoke density acc. to IEC 61034, Halogen-free acc. to 60754-2, Corrosiveness acc. to EN50267-2-3

## Application

HELUKAT® 500 data cables are used in the tertiary, but also in the secondary level of a network. They are characterized by large performance reserves and outstanding performance. They can be used to implement services such as 10Gigabit Ethernet, Gigabit Ethernet, Fast Ethernet, Ethernet, ATM155, FDDI, token ring 4/16 Mbit/s or ISDN absolutely trouble-free. Likewise, the mechanical characteristics are perfectly suited for the application in tight cable channels and platforms due to their optimized construction.

## Part no.

**803379**, F/FTP 2x4x2xAWG 23/1 LSZH (S-STP)

Dimensions and specifications may be changed without prior notice.



# LAN Cable

Category 6<sub>A</sub>

**HELUKAT® 500**

U/FTP, flex

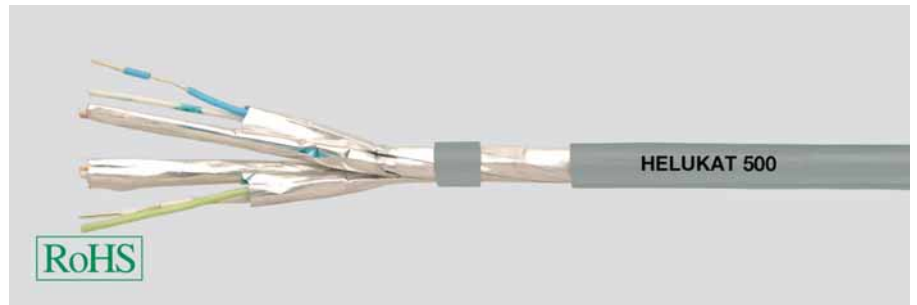
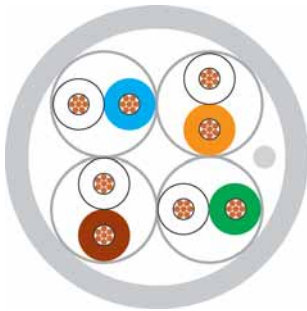

## Cable structure

Inner conductor Ø: 0,48 mm  
 Conductor material: Copper, bare  
 Core insulation: Foam-skin-PE  
 Core colours: wh/bu, wh/og, wh/gn, wh/bn  
 Separator: -  
 Screen over stranding element: Al-Foil  
 Screen 1 over stranding: -  
 Screen 2 over stranding: -  
 Drain wire: yes  
 Outer sheath material: LSZH  
 Outer diameter: app. 5,8 mm  
 Outer sheath colour: Grey similar to RAL 7035

## U/FTP 4x2xAWG 26/7 (stranded) LSZH

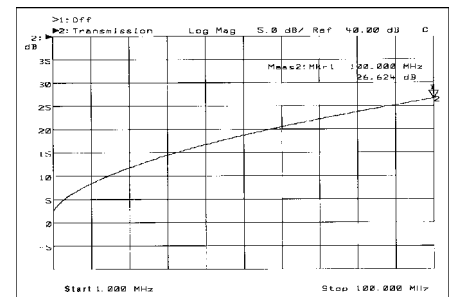

## Electrical data

Characteristic impedance: 100 Ohm ± 15 Ohm at 1 to 100 MHz  
 100 Ohm ± 20 Ohm at 101 to 500 MHz  
 Loop resistance: 330 Ohm/km max.  
 Mutual capacitance: 54 nF/km nom.  
 Rel. propagation velocity: 78 %

## Typical values

Frequency (MHz)	10	16	62,5	100	200	250	500
Attenuation (dB/10m)	0,8	1,1	2,1	2,7	3,9	4,4	6,3
Next (dB)	100,0	100,0	100,0	97,0	92,0	91,0	86,0
ACR (dB)	99,2	98,9	97,9	94,3	88,1	86,6	79,7

## Technical data

Weight: app. 35 kg/km  
 bending radius, repeated: 49 mm  
 Operating temperature range min.: -20°C  
 Operating temperature range max.: +60°C  
 Caloric load, approx. value: 0,39 MJ/m  
 Copper weight: 15,00 kg/km

## Norms

Acc. to ISO/IEC 11801, Acc. to EN 50173, Acc. to EIA/TIA 568-A, Category 6<sub>A</sub>, Flame-retardant acc. to IEC 60332-1-2, Smoke density acc. to IEC 61034, Halogen-free acc. to 60754-2, Corrosiveness acc. to EN50267-2-3

## Application

HELUKAT® 500 data cables are used in the tertiary level of a network as patch cables and connection cables. They are characterized by large performance reserves and outstanding performance. They can be used to implement services such as 10Gigabit Ethernet, Gigabit Ethernet, Fast Ethernet, Ethernet, ATM155, FDDI, token ring 4/16 Mbit/s or ISDN absolutely trouble-free. With its optimized construction, the HELUKAT® 500 series can be manufactured quickly and easily with many common RJ45 plugs.

## Part no.

**804043**, U/FTP 4x2xAWG 26/7 LSZH

Dimensions and specifications may be changed without prior notice.

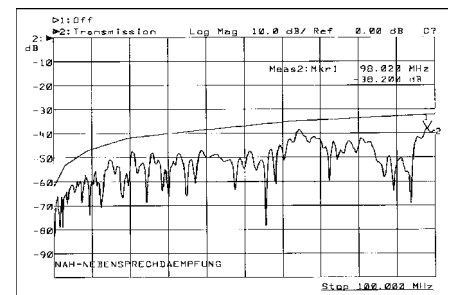

# LAN Cable

Category 7e

**HELUKAT®** 600

S/FTP

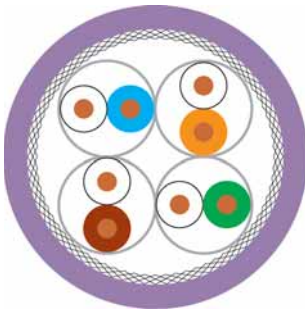

## Cable structure

Inner conductor Ø: 0,57 mm  
 Conductor material: Copper, bare  
 Core insulation: Foam-skin-PE  
 Core colours: wh/bu, wh/og, wh/gn, wh/bn  
 Separator: -  
 Screen over stranding element: Al-Foil  
 Screen 1 over stranding: Cu braid  
 Screen 2 over stranding: -  
 Outer sheath material: FRNC  
 Outer diameter: app. 7,5 mm  
 Outer sheath colour: Blue Lilac similar to RAL 4005

## S/FTP 4x2xAWG 23/1 FRNC

## Electrical data

Characteristic impedance: 100 Ohm ± 15 Ohm at 1 to 100 MHz  
 100 Ohm ± 20 Ohm at 101 to 1000 MHz  
 Loop resistance: 169 Ohm/km max.  
 Mutual capacitance: 43 nF/km nom.  
 Rel. propagation velocity: 79 %

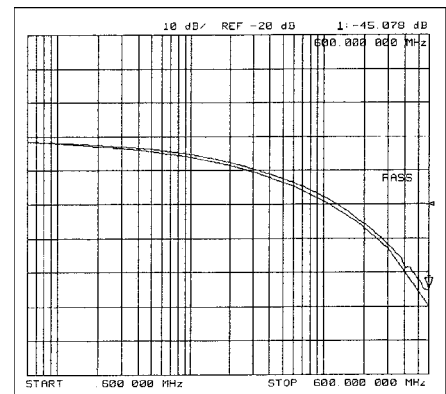

## Typical values

Frequency (MHz)	10	16	62,5	100	200	300	600	900	1000
Attenuation (dB/100m)	5,6	7,1	13,9	17,5	25,2	32,1	44,9	55,0	58,0
Next (dB)	100,0	100,0	96,0	94,0	88,0	84,0	73,0	71,0	69,0
ACR (dB)	94,4	92,9	82,1	76,5	62,8	51,9	28,1	16,0	9,0

## Technical data

Weight: app. 60 kg/km  
 bending radius, repeated: 60 mm  
 Operating temperature range min.: -20°C  
 Operating temperature range max.: +60°C  
 Caloric load, approx. value: 0,60 MJ/m  
 Copper weight: 28,00 kg/km

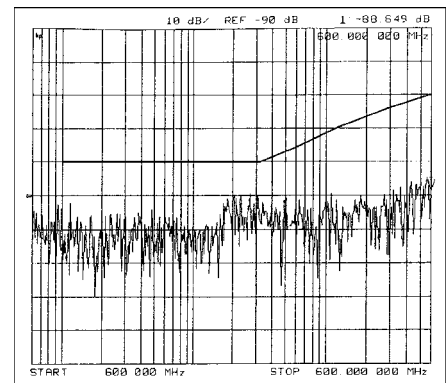

## Norms

Acc. to ISO/IEC 11801, Acc. to EN 50173, Acc. to EIA/TIA 568-A, Category 7e, Flame-retardant acc. to IEC 60332-3, Smoke density acc. to IEC 61034, Halogen-free acc. to 60754-2, Corrosiveness acc. to EN50267-2-3

## Application

HELUKAT®600 data cables are used in the tertiary, but also in the secondary level of a network. They are characterized by large performance reserves and outstanding performance. They can be used to implement services such as Gigabit Ethernet, Fast Ethernet, Ethernet, ATM155, FDDI, token ring 4/16 Mbit/s or ISDN absolutely trouble-free. Likewise, the mechanical characteristics are perfectly suited for the application in tight cable channels and platforms due to their optimized construction.

## Part no.

**80810**, S/FTP 4x2xAWG 23/1 FRNC (S-STP)

Dimensions and specifications may be changed without prior notice.

# LAN Cable

Category 7e

**HELUKAT® 600**

S/FTP duplex

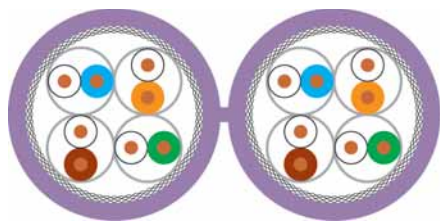

## Cable structure

Inner conductor Ø: 0,57 mm  
 Conductor material: Copper, bare  
 Core insulation: Foam-skin-PE  
 Core colours: wh/bu, wh/og, wh/gn, wh/bn  
 Separator: -  
 Screen over stranding element: Al-Foil  
 Screen 1 over stranding: Cu braid  
 Screen 2 over stranding: -  
 Outer sheath material: FRNC  
 Cable dimensions: app. 7,5 mm x 16,0 mm  
 Outer sheath colour: Blue Lilac similar to RAL 4005

## S/FTP 2x(4x2xAWG 23/1) FRNC

## Electrical data

Characteristic impedance: 100 Ohm ± 15 Ohm at 1 to 100 MHz  
 100 Ohm ± 20 Ohm at 101 to 1000 MHz  
 Loop resistance: 169 Ohm/km max.  
 Mutual capacitance: 43 nF/km nom.  
 Rel. propagation velocity: 79 %

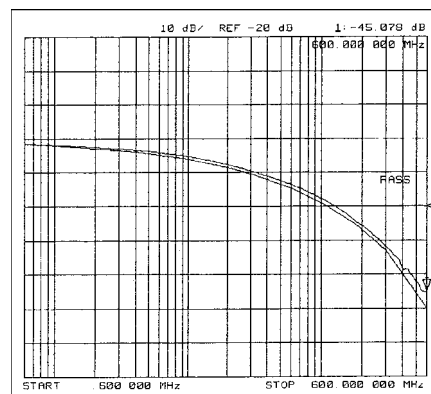

## Typical values

Frequency (MHz)	10	16	62,5	100	200	300	600	900	1000
Attenuation (dB/100m)	5,6	7,1	13,9	17,5	25,2	32,1	44,9	55,0	58,0
Next (dB)	100,0	100,0	96,0	94,0	88,0	84,0	73,0	71,0	69,0
ACR (dB)	94,4	92,9	82,1	76,5	62,8	51,9	28,1	16,0	9,0

## Technical data

Weight: app. 120 kg/km  
 bending radius, repeated: 60 mm  
 Operating temperature range min.: -20°C  
 Operating temperature range max.: +60°C  
 Caloric load, approx. value: 1,20 MJ/m  
 Copper weight: 56,00 kg/km

## Norms

Acc. to ISO/IEC 11801, Acc. to EN 50173, Acc. to EIA/TIA 568-A, Category 7e, Flame-retardant acc. to IEC 60332-3, Smoke density acc. to IEC 61034, Halogen-free acc. to 60754-2, Corrosiveness acc. to EN50267-2-3

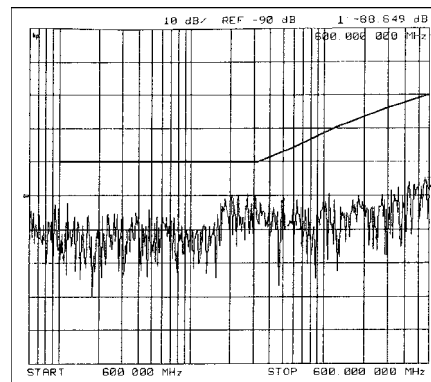

## Application

HELUKAT®600 data cables are used in the tertiary, but also in the secondary level of a network. They are characterized by large performance reserves and outstanding performance. They can be used to implement services such as Gigabit Ethernet, Fast Ethernet, Ethernet, ATM155, FDDI, token ring 4/16 Mbit/s or ISDN absolutely trouble-free. Likewise, the mechanical characteristics are perfectly suited for the application in tight cable channels and platforms due to their optimized construction.

## Part no.

**81446**, S/FTP 2x(4x2xAWG 23/1) FRNC (S-STP)

Dimensions and specifications may be changed without prior notice.

# LAN Cable

Category 7

**HELUKAT® 600**

S/FTP flex

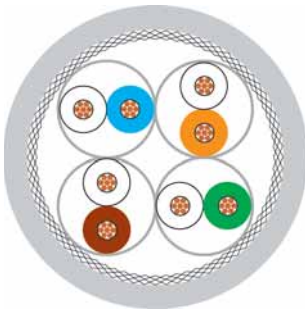

## Cable structure

Inner conductor Ø:  
Conductor material:  
Core insulation:  
Core colours:  
Separator:  
Screen over stranding element:  
Screen 1 over stranding:  
Screen 2 over stranding:  
Outer sheath material:  
Outer diameter:  
Outer sheath colour:

## S/FTP 4x2xAWG 26/7 FRNC

0,48 mm  
Copper, bare  
Foam-skin-PE  
wh/bu, wh/og, wh/gn, wh/bn  
-  
Al-Foil  
Cu braid  
-  
FRNC  
app. 5,9 mm  
Grey similar to RAL 7035

## Electrical data

Characteristic impedance: 100 Ohm ± 15 Ohm at 1 to 100 MHz  
100 Ohm ± 20 Ohm at 101 to 600 MHz  
Loop resistance: 290 Ohm/km max.  
Mutual capacitance: 45 nF/km nom.  
Rel. propagation velocity: 77 %

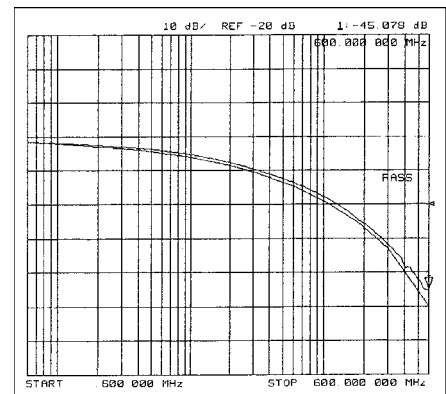

## Typical values

Frequency (MHz)	10	16	62,5	100	200	300	600
Attenuation (dB/10m)	0,8	1,0	2,0	2,6	4,0	4,9	6,3
Next (dB)	96,0	96,0	95,0	94,0	88,0	86,0	80,0
ACR (dB)	95,2	95,0	93,0	91,4	84,0	81,1	73,7

## Technical data

Weight: app. 42 kg/km  
bending radius, repeated: 55 mm  
Operating temperature range min.: -20°C  
Operating temperature range max.: +60°C  
Caloric load, approx. value: 0,47 MJ/m  
Copper weight: 22,00 kg/km

## Norms

Acc. to ISO/IEC 11801, Acc. to EN 50173, Acc. to EIA/TIA 568-A, Category 7, Flame-retardant acc. to IEC 60332-1-2, Smoke density acc. to IEC 61034, Halogen-free acc. to 60754-2, Corrosiveness acc. to EN50267-2-3

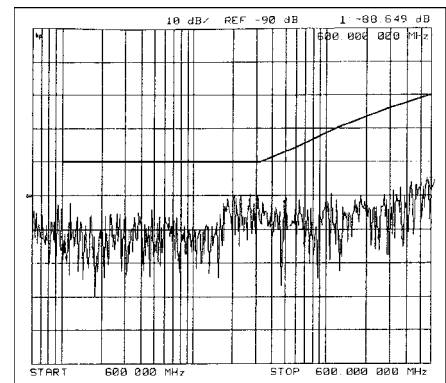

## Application

HELUKAT®600 data cables are used in the tertiary level of a network as patch cables and connection cables. They are characterized by large performance reserves and outstanding performance. They can be used to implement services such as Gigabit Ethernet, Fast Ethernet, Ethernet, ATM155, FDDI, token ring 4/16 Mbit/s or ISDN absolutely trouble-free. With its optimized construction, the HELUKAT®600 series can be manufactured quickly and easily with all common RJ45 plugs.

## Part no.

**80294**, S/FTP 4x2xAWG 26/7 FRNC (S-STP)

Dimensions and specifications may be changed without prior notice.

# LAN Cable Outdoor

Category 7e

**HELUKAT® 600A**

S/FTP PVC/PVC



## Cable structure

Inner conductor Ø:  
Conductor material:  
Core insulation:  
Core colours:  
Separator:  
Inner sheath material:  
Screen over stranding element:  
Screen 1 over stranding:  
Screen 2 over stranding:  
Outer sheath material:  
Outer diameter:  
Outer sheath colour:

## S/FTP 4x2xAWG 23/1 PVC/PVC

0,58 mm  
Copper, bare  
Foam-skin-PE  
wh/bu, wh/og, wh/gn, wh/bn  
-  
PVC  
Al-Foil  
Cu braid  
-  
PVC  
app. 11,6 mm  
Black similar to RAL 9005

## Electrical data

Characteristic impedance:

100 Ohm ± 15 Ohm at 1 to 100 MHz  
100 Ohm ± 20 Ohm at 101 to 1000 MHz

Loop resistance:

160 Ohm/km max.

Mutual capacitance:

43 nF/km nom.

Rel. propagation velocity:

79 %

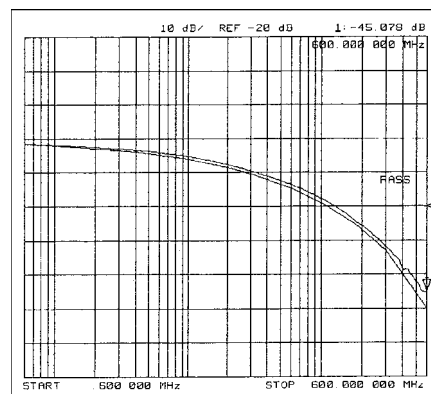

## Typical values

Frequency (MHz)	10	16	62,5	100	200	300	600	900	1000
Attenuation (dB/100m)	5,6	7,1	13,9	17,5	25,2	32,1	44,9	55,0	58,0
Next (dB)	100,0	100,0	96,0	94,0	88,0	84,0	73,0	71,0	69,0
ACR (dB)	94,4	92,9	82,1	76,5	62,8	51,9	28,1	16,0	9,0

## Technical data

Weight: app. 153 kg/km  
bending radius, repeated: 95 mm  
Operating temperature range min.: -30°C  
Operating temperature range max.: +70°C  
Caloric load, approx. value: 2,62 MJ/m  
Copper weight: 32,00 kg/km

## Norms

Acc. to ISO/IEC 11801, Acc. to EN 50173, Acc. to EIA/TIA 568-A, Category 7e, Flame-retardant acc. to IEC 60332-1-2

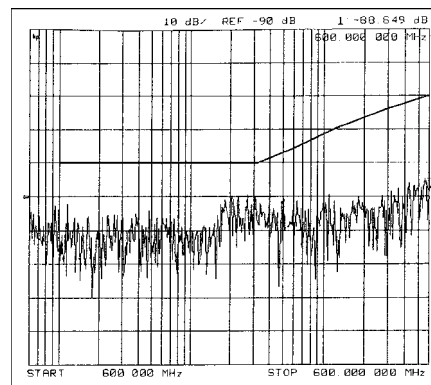

## Application

HELUKAT® 600A data cables are used in the tertiary, but also in the secondary level of a network. They are characterized by large performance reserves and outstanding performance. They can be used to implement services such as Gigabit Ethernet, Fast Ethernet, Ethernet, ATM155, FDDI, token ring 4/16 Mbit/s or ISDN absolutely trouble-free. The series of HELUKAT® 600A with a double PVC jacket is constructed especially for outdoor applications like laying at house walls or in cable lines.

## Part no.

**801147**, S/FTP 4x2xAWG 23/1 PVC/PVC (S-STP)

Dimensions and specifications may be changed without prior notice.

# LAN Cable direct Burial

Category 7e

**HELUKAT® 600E**

S/FTP PVC

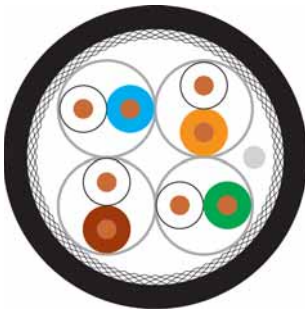

## Cable structure

Inner conductor Ø:  
Conductor material:  
Core insulation:  
Core colours:  
Separator:  
Screen over stranding element:  
Screen 1 over stranding:  
Screen 2 over stranding:  
Outer sheath material:  
Outer diameter:  
Outer sheath colour:

## S/FTP 4x2xAWG 23/1 direct burial

0,58 mm  
Copper, bare  
Foam-skin-PE  
wh/bu, wh/og, wh/gn, wh/bn  
-  
Al-Foil  
Cu braid  
-  
PVC  
app. 9,8 mm  
Black

## Electrical data

Characteristic impedance: 100 Ohm ± 15 Ohm at 1 to 100 MHz  
100 Ohm ± 20 Ohm at 101 to 1000 MHz  
Loop resistance: 150 Ohm/km max.  
Mutual capacitance: 42 nF/km nom.  
Rel. propagation velocity: 79 %

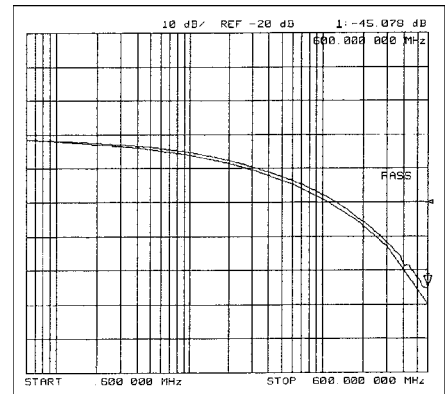

## Typical values

Frequency (MHz)	10	16	62,5	100	200	300	600	900	1000
Attenuation (dB/100m)	5,6	7,1	13,9	17,5	25,2	32,1	44,9	55,0	58,0
Next (dB)	100,0	100,0	96,0	94,0	88,0	84,0	73,0	71,0	69,0
ACR (dB)	94,4	92,9	82,1	76,5	62,8	51,9	28,1	16,0	9,0

## Technical data

Weight: app. 102 kg/km  
bending radius, repeated: 100 mm  
Operating temperature range min.: -45°C  
Operating temperature range max.: +65°C  
Caloric load, approx. value: 1,40 MJ/m  
Copper weight: 32,00 kg/km

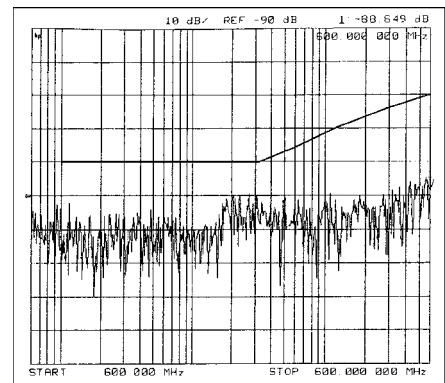

## Norms

Acc. to ISO/IEC 11801, Acc. to EN 50173, Acc. to EIA/TIA 568-A, Category 7e, Flame-retardant acc. to IEC 60332-1-2, Smoke density acc. to IEC 61034

## Application

HELUKAT® 600E data cables are used in the tertiary, but also in the secondary level of a network. They are characterized by large performance reserves and outstanding performance. They can be used to implement services such as Gigabit Ethernet, Fast Ethernet, Ethernet, ATM155, FDDI, token ring 4/16 Mbit/s or ISDN absolutely trouble-free. The series of HELUKAT® 600E with a cold resistant PVC jacket is constructed especially for outdoor applications like laying at house walls or direct burial.

## Part no.

**802167**, S/FTP 4x2xAWG23/1 PVC (S-STP)

Dimensions and specifications may be changed without prior notice.

# LAN Cable direct Burial / armoured

Category 7e

**HELUKAT® 600AE**  
S/FTP FRNC/PE

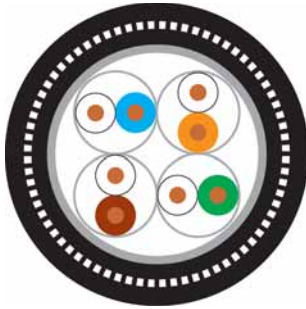

## Cable structure

Inner conductor Ø:  
Conductor material:  
Core insulation:  
Core colours:  
Separator:  
Inner sheath material:  
Screen over stranding element:  
Screen 1 over stranding:  
Screen 2 over stranding:  
:  
Outer sheath material:  
Outer diameter:  
Outer sheath colour:

## S/FTP 4x2xAWG 23/1 FRNC/PE

0,58 mm  
Copper, bare  
Foam-skin-PE  
wh/bu, wh/og, wh/gn, wh/bn  
-  
FRNC  
Al-Foil  
Cu braid  
-  
Steel shaft  
PE  
app. 12,2 mm  
Black

## Electrical data

Characteristic impedance:  
Loop resistance:  
Mutual capacitance:  
Rel. propagation velocity:

100 Ohm ± 15 Ohm at 1 to 100 MHz  
100 Ohm ± 20 Ohm at 101 to 1000 MHz  
150 Ohm/km max.  
43 nF/km nom.  
79 %

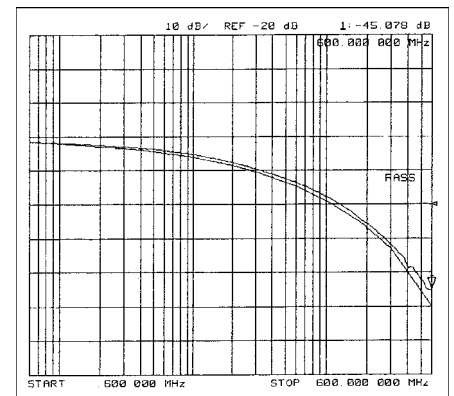

## Typical values

Frequency (MHz)	10	16	62,5	100	200	300	600	900	1000
Attenuation (dB/100m)	5,6	7,1	13,9	17,5	25,2	32,1	44,9	55,0	58,0
Next (dB)	100,0	100,0	96,0	94,0	88,0	84,0	73,0	71,0	69,0
ACR (dB)	94,4	92,9	82,1	76,5	62,8	51,9	28,1	16,0	9,0

## Technical data

Weight:  
bending radius, repeated:  
Operating temperature range min.:  
Operating temperature range max.:  
Caloric load, approx. value:  
Copper weight:

app. 155 kg/km  
330 mm  
-45°C  
+70°C  
2,30 MJ/m  
32,00 kg/km

## Norms

Acc. to ISO/IEC 11801, Acc. to EN 50173, Acc. to EIA/TIA 568-A, Category 7e

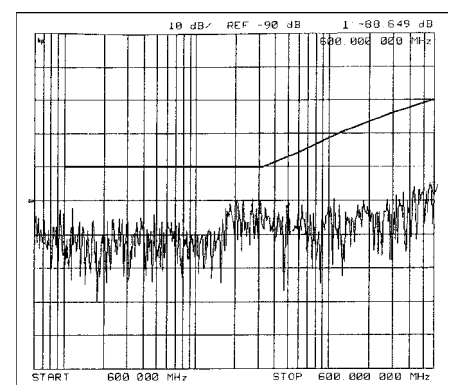

## Application

HELUKAT® 600AE data cables are used in the tertiary, but also in the secondary level of a network. They are characterized by large performance reserves and outstanding performance. They can be used to implement services such as Gigabit Ethernet, Fast Ethernet, Ethernet, ATM155, FDDI, token ring 4/16 Mbit/s or ISDN absolutely trouble-free. The series of HELUKAT® 600AE with a FRNC/PE double jacket and the rodent protection is constructed especially for outdoor and direct burial applications.

## Part no.

**802168**, S/FTP 4x2xAWG 23/1 FRNC/PE (S-STP)

Dimensions and specifications may be changed without prior notice.

# LAN Cable

Category 7<sub>A</sub>

**HELUKAT®** 1200

S/FTP

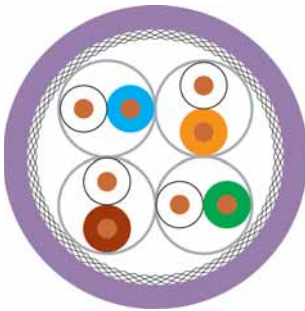

## Cable structure

Inner conductor Ø:  
Conductor material:  
Core insulation:  
Core colours:  
Separator:  
Screen over stranding element:  
Screen 1 over stranding:  
Screen 2 over stranding:  
Outer sheath material:  
Outer diameter:  
Outer sheath colour:

## S/FTP 4x2xAWG 23/1 LSZH

0,57 mm  
Copper, bare  
Foam-skin-PE  
wh/bu, wh/og, wh/gn, wh/bn  
-  
Al-Foil  
Cu braid  
-  
LSZH  
app. 7,5 mm  
Blue Lilac similar to RAL 4005

## Electrical data

Characteristic impedance:

100 Ohm ± 15 Ohm at 1 to 100 MHz  
100 Ohm ± 20 Ohm at 101 to 1200 MHz

Loop resistance:

160 Ohm/km max.

Mutual capacitance:

43 nF/km nom.

Rel. propagation velocity:

77 %

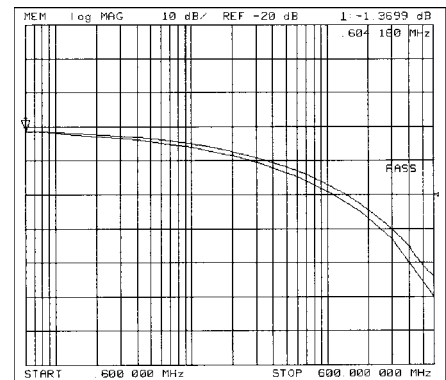

## Typical values

Frequency (MHz)	10	16	62,5	100	200	300	600	900	1000	1200
Attenuation (dB/100m)	5,2	6,8	13,3	17,3	24,2	30,2	43,5	54,3	56,9	62,9
Next (dB)	105,0	105,0	105,0	100,0	95,0	93,0	88,0	85,0	84,0	82,0
ACR (dB)	99,8	98,2	91,7	82,7	70,8	62,8	44,5	30,7	27,1	19,1

## Technical data

Weight: app. 60 kg/km  
bending radius, repeated: 65 mm  
Operating temperature range min.: -20°C  
Operating temperature range max.: +60°C  
Caloric load, approx. value: 0,57 MJ/m  
Copper weight: 30,00 kg/km

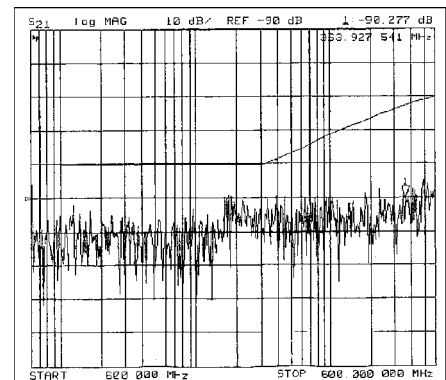

## Norms

Acc. to ISO/IEC 11801, Acc. to EN 50173, Acc. to EIA/TIA 568-A, Category 7<sub>A</sub>, Flame-retardant acc. to IEC 60332-3, Smoke density acc. to IEC 61034, Halogen-free acc. to 60754-2, Corrosiveness acc. to EN50267-2-3

## Application

HELUKAT®1200-7A data cables are used in the tertiary, but also in the secondary level of a network. They are characterized by large performance reserves and outstanding performance. They can be used to implement services such as 10Gigabit Ethernet, Gigabit Ethernet, Fast Ethernet, Ethernet, ATM155, FDDI, token ring 4/16 Mbit/s or ISDN absolutely trouble-free. Likewise, the mechanical characteristics are perfectly suited for the application in tight cable channels and platforms due to their optimized construction.

## Part no.

**803380**, S/FTP 4x2xAWG 23/1 FRNC (S-STP)

Dimensions and specifications may be changed without prior notice.



# LAN Cable

Category 7<sub>A</sub>

**HELUKAT® 1200**

S/FTP duplex

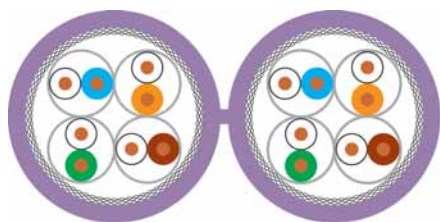

## Cable structure

Inner conductor Ø: 0,57 mm  
 Conductor material: Copper, bare  
 Core insulation: Foam-skin-PE  
 Core colours: wh/bu, wh/og, wh/gn, wh/bn  
 Separator: -  
 Screen over stranding element: Al-Foil  
 Screen 1 over stranding: Cu braid  
 Screen 2 over stranding: -  
 Outer sheath material: LSZH  
 Cable dimensions: app. 16,0 mm x 7,5 mm  
 Outer sheath colour: Blue Lilac similar to RAL 4005

## S/FTP 2x(4x2xAWG 23/1) LSZH

## Electrical data

Characteristic impedance: 100 Ohm ± 15 Ohm at 1 to 100 MHz  
 100 Ohm ± 20 Ohm at 101 to 1200 MHz  
 Loop resistance: 160 Ohm/km max.  
 Mutual capacitance: 43 nF/km nom.  
 Rel. propagation velocity: 77 %

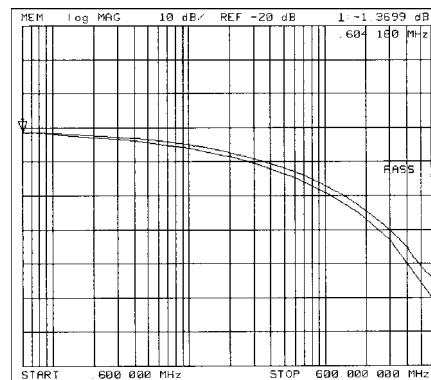

## Typical values

Frequency (MHz)	10	16	62,5	100	200	300	600	900	1000	1200
Attenuation (dB/100m)	5,2	6,8	13,3	17,3	24,2	30,2	43,5	54,3	56,9	62,9
Next (dB)	105,0	105,0	105,0	100,0	95,0	93,0	88,0	85,0	84,0	82,0
ACR (dB)	99,8	98,2	91,7	82,7	70,8	62,8	44,5	30,7	27,1	19,1

## Technical data

Weight: app. 120 kg/km  
 bending radius, repeated: 65 mm  
 Operating temperature range min.: -20°C  
 Operating temperature range max.: +60°C  
 Caloric load, approx. value: 1,16 MJ/m  
 Copper weight: 60,00 kg/km

## Norms

Acc. to ISO/IEC 11801, Acc. to EN 50173, Acc. to EIA/TIA 568-A, Category 7<sub>A</sub>, Flame-retardant acc. to IEC 60332-3, Smoke density acc. to IEC 61034, Halogen-free acc. to 60754-2, Corrosiveness acc. to EN50267-2-3

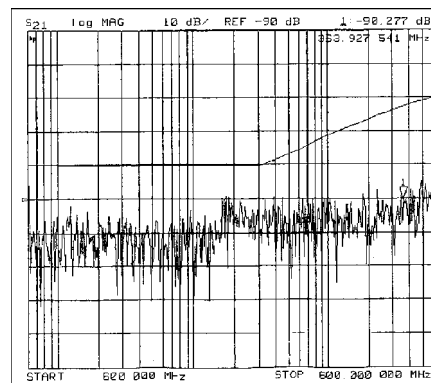

## Application

HELUKAT® 1200-7A data cables are used in the tertiary, but also in the secondary level of a network. They are characterized by large performance reserves and outstanding performance. They can be used to implement services such as 10Gigabit Ethernet, Gigabit Ethernet, Fast Ethernet, Ethernet, ATM155, FDDI, token ring 4/16 Mbit/s or ISDN absolutely trouble-free. Likewise, the mechanical characteristics are perfectly suited for the application in tight cable channels and platforms due to their optimized construction.

## Part no.

**803381**, S/FTP 2x(4x2xAWG 23/1) FRNC (S-STP)

Dimensions and specifications may be changed without prior notice.

# LAN Cable

Category 8

**HELUKAT® 1200**

S/FTP

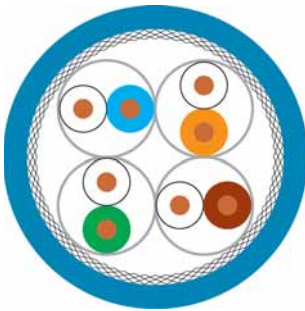

## Cable structure

Inner conductor Ø: 0,64 mm  
 Conductor material: Copper, bare  
 Core insulation: Foam-skin-PE  
 Core colours: wh/bu, wh/og, wh/gn, wh/bn  
 Separator: -  
 Screen over stranding element: Al-Foil  
 Screen 1 over stranding: Cu braid  
 Screen 2 over stranding: -  
 Outer sheath material: FRNC  
 Outer diameter: app. 7,7 mm  
 Outer sheath colour: Blue similar to RAL 5015

## S/FTP 4x2xAWG 22/1 FRNC

## Electrical data

Characteristic impedance: 100 Ohm ± 15 Ohm at 1 to 100 MHz  
 100 Ohm ± 20 Ohm at 101 to 1200 MHz  
 Loop resistance: 120 Ohm/km max.  
 Mutual capacitance: 43 nF/km nom.  
 Rel. propagation velocity: 79 %

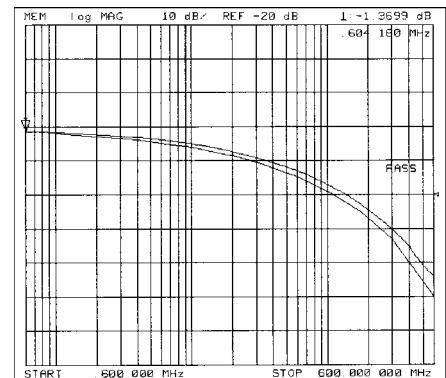

## Typical values

Frequency (MHz)	10	16	62,5	100	200	300	600	1000	1200
Attenuation (dB/100m)	4,9	6,3	12,7	16,3	23,5	29,4	42,8	53,0	59,0
Next (dB)	100,0	100,0	95,0	93,0	90,0	87,0	81,0	78,0	77,0
ACR (dB)	95,1	93,7	82,3	76,7	66,5	57,6	38,2	25,0	18,0

## Technical data

Weight: app. 66 kg/km  
 bending radius, repeated: 72 mm  
 Operating temperature range min.: -20°C  
 Operating temperature range max.: +60°C  
 Caloric load, approx. value: 0,70 MJ/m  
 Copper weight: 40,00 kg/km

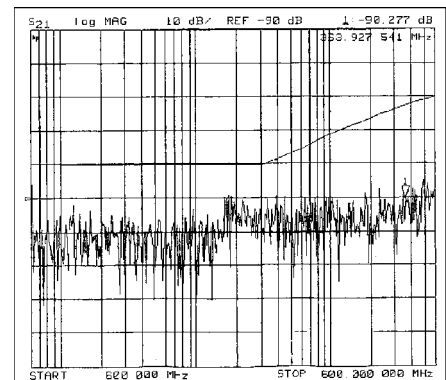

## Norms

Acc. to ISO/IEC 11801, Acc. to EN 50173, Acc. to EIA/TIA 568-A, Category 8 (draft),  
 Flame-retardant acc. to IEC 60332-3, Smoke density acc. to IEC 61034, Halogen-free acc. to 60754-2, Corrosiveness acc. to EN50267-2-3

## Application

HELUKAT®1200 data cables are used in the tertiary, but also in the secondary level of a network. They are characterized by large performance reserves and outstanding performance. They can be used to implement services such as Gigabit Ethernet, Fast Ethernet, Ethernet, ATM155, FDDI, token ring 4/16 Mbit/s or ISDN absolutely trouble-free. Likewise, the mechanical characteristics are perfectly suited for the application in tight cable channels and platforms due to their optimized construction.

## Part no.

**81699**, S/FTP 4x2xAWG 22/1 FRNC (S-FTP)

Dimensions and specifications may be changed without prior notice.

# LAN Cable

Category 8

**HELUKAT® 1200**

S/FTP duplex

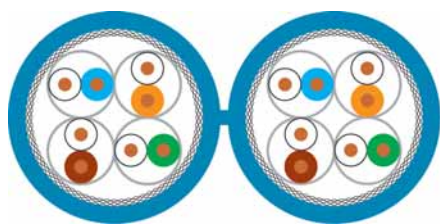

## Cable structure

Inner conductor Ø: 0,64 mm  
 Conductor material: Copper, bare  
 Core insulation: Foam-skin-PE  
 Core colours: wh/bu, wh/og, wh/gn, wh/bn  
 Separator: -  
 Screen over stranding element: Al-Foil  
 Screen 1 over stranding: Cu braid  
 Screen 2 over stranding: -  
 Outer sheath material: FRNC  
 Cable dimensions: app. 7,7 mm x 16,5 mm  
 Outer sheath colour: Blue similar to RAL 5015

## S/FTP 2x(4x2xAWG 22/1) FRNC

## Electrical data

Characteristic impedance: 100 Ohm ± 15 Ohm at 1 to 100 MHz  
 100 Ohm ± 20 Ohm at 101 to 1200 MHz  
 Loop resistance: 120 Ohm/km max.  
 Mutual capacitance: 43 nF/km nom.  
 Rel. propagation velocity: 79 %

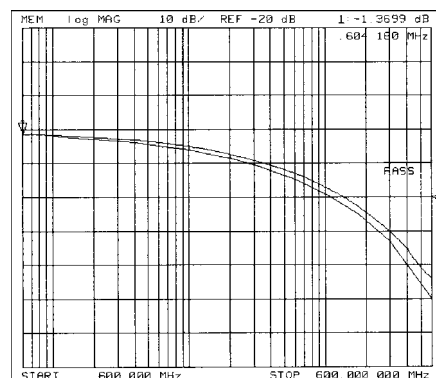

## Typical values

Frequency (MHz)	10	16	62,5	100	200	300	600	1000	1200
Attenuation (dB/100m)	4,9	6,3	12,7	16,3	23,5	29,4	42,8	53,0	59,0
Next (dB)	100,0	100,0	95,0	93,0	90,0	87,0	81,0	78,0	77,0
ACR (dB)	95,1	93,7	82,3	76,7	66,5	57,6	38,2	25,0	18,0

## Technical data

Weight: app. 133 kg/km  
 bending radius, repeated: 72 mm  
 Operating temperature range min.: -20°C  
 Operating temperature range max.: +60°C  
 Caloric load, approx. value: 1,50 MJ/m  
 Copper weight: 80,00 kg/km

## Norms

Acc. to ISO/IEC 11801, Acc. to EN 50173, Acc. to EIA/TIA 568-A, Category 8 (draft),  
 Flame-retardant acc. to IEC 60332-3, Smoke density acc. to IEC 61034, Halogen-free acc. to 60754-2, Corrosiveness acc. to EN50267-2-3

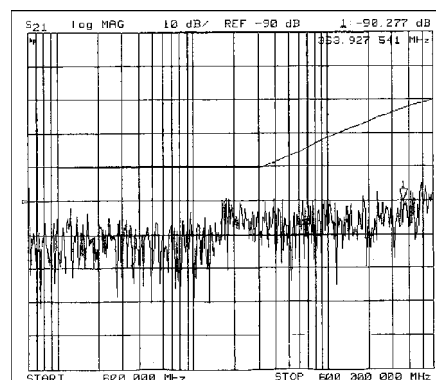

## Application

HELUKAT® 1200 data cables are used in the tertiary, but also in the secondary level of a network. They are characterized by large performance reserves and outstanding performance. They can be used to implement services such as Gigabit Ethernet, Fast Ethernet, Ethernet, ATM155, FDDI, token ring 4/16 Mbit/s or ISDN absolutely trouble-free. Likewise, the mechanical characteristics are perfectly suited for the application in tight cable channels and platforms due to their optimized construction.

## Part no.

**800647**, S/FTP 2x(4x2xAWG 22/1) FRNC (S-STP)

Dimensions and specifications may be changed without prior notice.

# Multimedia Cable

Category 8

**HELUKAT® 1500**

S/FTP

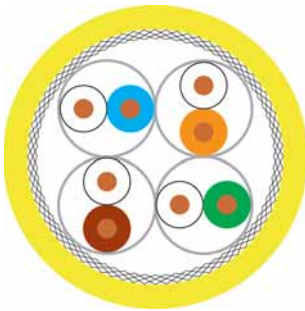

## Cable structure

Inner conductor Ø: 0,64 mm  
 Conductor material: Copper, bare  
 Core insulation: Foam-skin-PE  
 Core colours: wh/bu, wh/og, wh/gn, wh/bn  
 Separator: -  
 Screen over stranding element: Al-Foil  
 Screen 1 over stranding: Cu braid  
 Screen 2 over stranding: -  
 Outer sheath material: FRNC  
 Outer diameter: app. 7,7 mm  
 Outer sheath colour: Yellow

## S/FTP 4x2xAWG 22/1 FRNC

## Electrical data

Characteristic impedance: 100 Ohm ± 15 Ohm at 1 to 100 MHz  
 100 Ohm ± 20 Ohm at 101 to 1200 MHz  
 Loop resistance: 120 Ohm/km max.  
 Mutual capacitance: 42 nF/km nom.  
 Rel. propagation velocity: 77 %

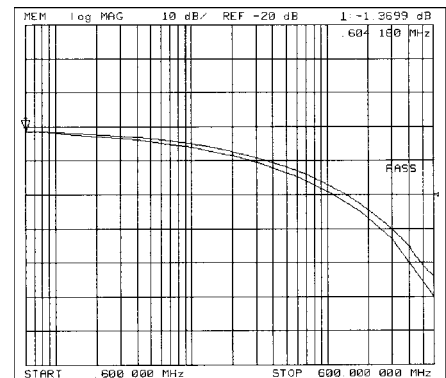

## Typical values

Frequency (MHz)	10	16	62,5	100	200	300	600	1000	1200	1500
Attenuation (dB/100m)	4,2	6,3	12,7	16,5	21,5	27,5	41,7	54,4	59,8	66,2
Next (dB)	110,0	110,0	110,0	110,0	110,0	105,0	95,0	85,0	80,0	74,0
ACR (dB)	105,8	103,7	97,3	93,5	88,5	77,5	53,3	30,6	22,2	7,8

## Technical data

Weight: app. 66 kg/km  
 bending radius, repeated: 68 mm  
 Operating temperature range min.: -20°C  
 Operating temperature range max.: +60°C  
 Caloric load, approx. value: 0,74 MJ/m  
 Copper weight: 41,00 kg/km

## Norms

Acc. to ISO/IEC 11801, Acc. to EN 50173, Acc. to EIA/TIA 568-A, Category 8 (draft),  
 Flame-retardant acc. to IEC 60332-3, Smoke density acc. to IEC 61034, Halogen-free acc. to 60754-2, Corrosiveness acc. to EN50267-2-3

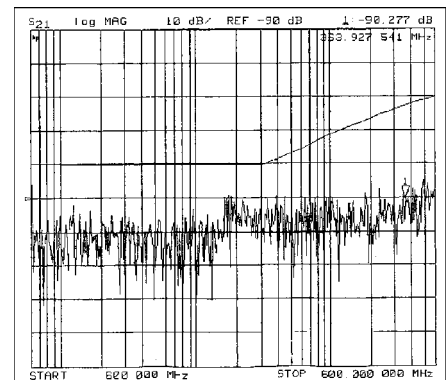

## Application

HELUKAT® 1500 data cables are used in the tertiary, but also in the secondary level of a network. They are characterized by large performance reserves and outstanding performance. They can be used to implement services such as 10Gigabit Ethernet, Gigabit Ethernet, Fast Ethernet, Ethernet, ATM155, FDDI, token ring 4/16 Mbit/s or ISDN absolutely trouble-free. That means applications such as multimedia (TV, Video, Data, Speech) are no problem for this series. Likewise, the mechanical characteristics are perfectly suited for the application in tight cable channels and platforms due to their optimized construction.

## Part no.

**802169**, S/FTP 4x2xAWG 22/1 FRNC (S-STP)

Dimensions and specifications may be changed without prior notice.

# Multimedia Cable

Category 8

**HELUKAT® 1500**

S/FTP duplex

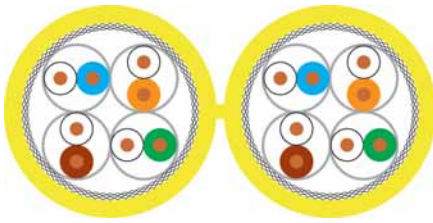

## Cable structure

Inner conductor Ø: 0,64 mm  
 Conductor material: Copper, bare  
 Core insulation: Foam-skin-PE  
 Core colours: wh/bu, wh/og, wh/gn, wh/bn  
 Separator: -  
 Screen over stranding element: Al-Foil  
 Screen 1 over stranding: Cu braid  
 Screen 2 over stranding: -  
 Outer sheath material: FRNC  
 Cable dimensions: app. 7,7 mm x 16,2 mm  
 Outer sheath colour: Yellow

## S/FTP 2x(4x2xAWG 22/1) FRNC

## Electrical data

Characteristic impedance: 100 Ohm ± 15 Ohm at 1 to 100 MHz  
 100 Ohm ± 20 Ohm at 101 to 1200 MHz  
 Loop resistance: 120 Ohm/km max.  
 Mutual capacitance: 42 nF/km nom.  
 Rel. propagation velocity: 77 %

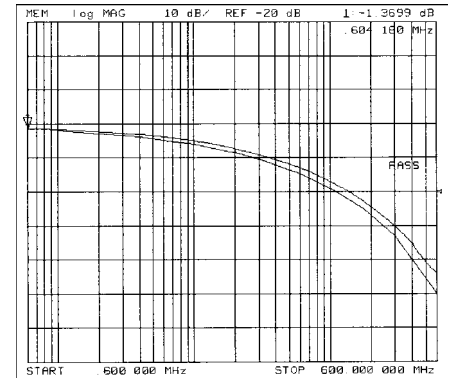

## Typical values

Frequency (MHz)	10	16	62,5	100	200	300	600	1000	1200	1500
Attenuation (dB/100m)	4,2	6,3	12,7	16,5	21,5	27,5	41,7	54,4	59,8	66,2
Next (dB)	110,0	110,0	110,0	110,0	110,0	105,0	95,0	85,0	80,0	74,0
ACR (dB)	105,8	103,7	97,3	93,5	88,5	77,5	53,3	30,6	22,2	7,8

## Technical data

Weight: app. 135 kg/km  
 bending radius, repeated: 68 mm  
 Operating temperature range min.: -20°C  
 Operating temperature range max.: +60°C  
 Caloric load, approx. value: 1,50 MJ/m  
 Copper weight: 82,00 kg/km

## Norms

Acc. to ISO/IEC 11801, Acc. to EN 50173, Acc. to EIA/TIA 568-A, Category 8 (draft),  
 Flame-retardant acc. to IEC 60332-3, Smoke density acc. to IEC 61034, Halogen-free acc. to 60754-2, Corrosiveness acc. to EN50267-2-3

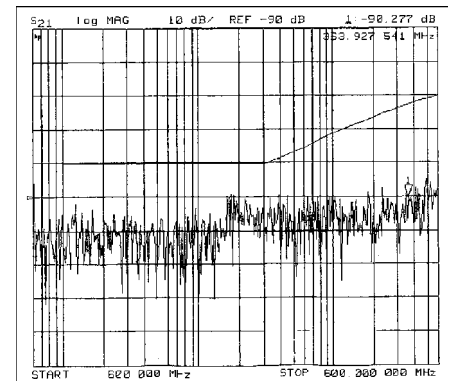

## Application

HELUKAT® 1500 data cables are used in the tertiary, but also in the secondary level of a network. They are characterized by large performance reserves and outstanding performance. They can be used to implement services such as 10Gigabit Ethernet, Gigabit Ethernet, Fast Ethernet, Ethernet, ATM155, FDDI, token ring 4/16 Mbit/s or ISDN absolutely trouble-free. That means applications such as multimedia (TV, Video, Data, Speech) are no problem for this series. Likewise, the mechanical characteristics are perfectly suited for the application in tight cable channels and platforms due to their optimized construction.

## Part no.

**802170**, S/FTP 2x(4x2xAWG 22/1) FRNC (S-STP)

Dimensions and specifications may be changed without prior notice.

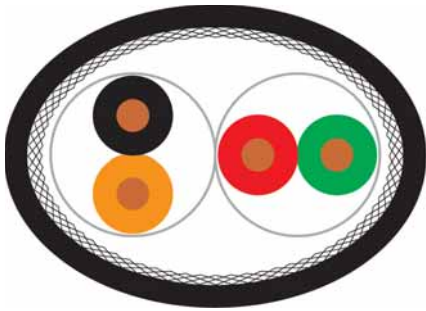

## Cable structure

Inner conductor Ø:  
 Conductor material:  
 Core insulation:  
 Number of cores:  
 Core colours:  
 Screen over stranding element:  
 Screen over stranding 1:  
 Screen over stranding 2:  
 Outer sheath material:  
 Cable dimensions:  
 Outer sheath colour:

### IBM P/N 33G2772 type 1A

0,64 mm  
 Copper, bare  
 Foam-skin-PE  
 4  
 bk/og, rd/gn  
 Al-Foil  
 Cu braid, tinned  
 -  
 PVC  
 app. 7,6 mm x 11,9 mm  
 Black

### IBM P/N 33G2775 type 6A

0,48 mm  
 Copper, bare  
 Foam-skin-PE  
 4  
 bk/og, rd/gn  
 Al-Foil  
 Cu braid, tinned  
 -  
 PVC  
 app. 7,8 mm  
 Black

### IBM P/N 33G8224 type 1A mini

0,4 mm  
 Copper, bare  
 Foam-skin-PE  
 4  
 bk/og, rd/gn  
 Al-Foil  
 Cu braid, tinned  
 -  
 PVC  
 app. 5,5 mm x 8,9 mm  
 Black

## Electrical data

Characteristic impedance:

150 Ohm  
 ± 15 Ohm at 3 to 20 MHz  
 185 Ohm  
 ± 18.5 Ohm at 38.4 kHz  
 270 Ohm  
 ± 27 Ohm at 9.6 kHz  
 57,1 Ohm/km  
 78 %

150 Ohm  
 ± 15 Ohm at 3 to 20 MHz  
 235 Ohm  
 ± 35.25 Ohm at 38.4 kHz  
 390 Ohm  
 ± 58.5 Ohm at 9.6 kHz  
 151 Ohm/km  
 -

150 Ohm  
 ± 15 Ohm at 3 to 20 MHz  
 235 Ohm  
 ± 23.5 Ohm at 38.4 kHz  
 390 Ohm  
 ± 39 Ohm at 9.6 kHz  
 151 Ohm/km  
 78 %

Direct current resistance:  
 Rel. propagation velocity:

## Typical values

Frequency (MHz)		20	100	20	100	20	100
Attenuation (dB/100m)		7,4	18,7	4,9	12,3	7,4	18,7
Next (dB)		80,0	60,0	50,0	39,0	60,0	49,0

## Technical data

Weight: app. 85 kg/km      app. 70 kg/km      app. 60 kg/km  
 bending radius, repeated: 110 mm      117 mm      84 mm  
 Operating temperature range min.: -10°C      -10°C      -10°C  
 Operating temperature range max.: +70°C      +70°C      +70°C  
 Caloric load, approx. value: 1,70 MJ/m      0,78 MJ/m      0,68 MJ/m  
 Copper weight: 38,00 kg/km      25,00 kg/km      21,00 kg/km

## Application

HELUKABEL® IVS types are used in the area of the IVS system, developed by IBM. They correspond to the wiring guidelines set by IBM.

## Part no.

**80068**, IBM P/N 33G2772  
type 1A

**80071**, IBM P/N 33G2775  
type 6A

**80070**, IBM P/N 33G8224  
type 1A mini

Dimensions and specifications may be changed without prior notice.

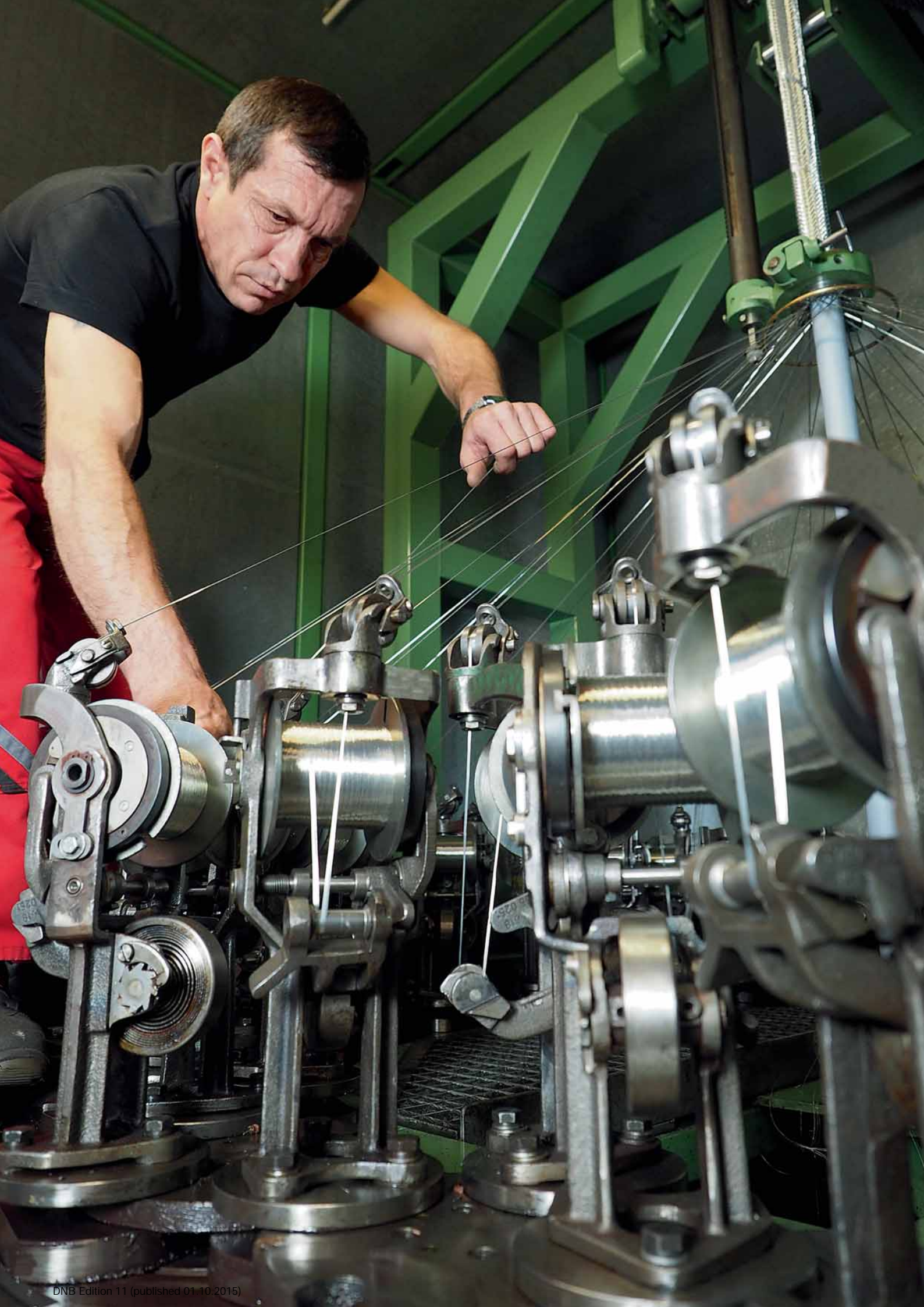

**BUS-Cables USB 3.0 Bus**

BUS-Cables E-Bus

BUS-Cables Profibus SHIPLINE

**BUS-Cables CAN Bus**

Industrial Ethernet PROFINet type A

Industrial Ethernet 200IND SF/UTP ROBUSTFLEX

Industrial Ethernet PROFINet C Torsion





# BUS-CABLES

Designation	Page
<b>Industrial Ethernet</b>	
Industrial Ethernet HELUKAT® 600IND S/FTP solid, ROBUST Cat.7e	129
Industrial Ethernet HELUKAT® 1200IND S/FTP solid, ROBUST Cat.7	130
Industrial Ethernet HELUKAT® 1000IND S/FTP Robustflex, Cat.7 <sub>A</sub>	131
Industrial Ethernet HELUKAT® 600S SF/FTP drag chain Cat.7	132
Industrial Ethernet HELUKAT® 600IND S/FTP SHIPLINE Cat.7	133
Industrial Ethernet HELUKAT® 600IND S/FTP Robustflex, Cat.7	134
Industrial Ethernet HELUKAT® 500 IND S/FTP Standard cable PVC Cat.6 <sub>A</sub>	135
Industrial Ethernet HELUKAT® 500S S/FTP drag chain PVC/PUR Cat.6 <sub>A</sub>	136
Industrial Ethernet HELUKAT® 500S SF/FTP PUR UL CMX Drag chain Cat.6 <sub>A</sub>	137
Industrial Ethernet HELUKAT® 250IND SF/UTP Standard cable PVC CMG Cat.6	138
Industrial Ethernet HELUKAT® 250IND SF/UTP Standard cable PVC AWM Cat.6	139
Industrial Ethernet HELUKAT® 250S SF/UTP Drag chain PVC UL CMG Cat.6	140
Industrial Ethernet HELUKAT® 250S SF/UTP PUR UL CMX Drag chain Cat.6	141
Industrial Ethernet HELUKAT® 100IND SF/UTP 2 Pairs, FRNC and PUR Cat.5e	142
Industrial Ethernet HELUKAT® 100IND SF/UTP Flex 2 Pairs, FRNC and PUR Cat.5e	143
Industrial Ethernet HELUKAT® 200IND SF/UTP 4 Pairs Robustflex PUR Cat.5e	144
Industrial Ethernet HELUKAT® 100IND WK 105° Cat.5	145
Industrial Ethernet HELUKAT® 100S ECO SF/UTP 4 Pairs, Drag chain Cat.5e	146
Industrial Ethernet HELUKAT® 100S ECO SF/UTP 4 Pairs, Drag chain Cat.5e	147
Industrial Ethernet HELUKAT® 200S SF/UTP 4 Pairs, Drag chain Cat.5	148
Industrial Ethernet HELUKAT® 200S SF/UTP 4 Pairs, Drag chain Cat.5	149
Industrial Ethernet HELUKAT® 100T SF/UTP 4 Pairs Tordierflex Cat.5	150
<b>PROFINet</b>	
Industrial Ethernet PROFINet type A, PVC and PUR	151
Industrial Ethernet PROFINet type A, FRNC	152
Industrial Ethernet PROFINet type A, radiation resistant and armoured	153
Industrial Ethernet PROFINet type B, PVC	154
Industrial Ethernet PROFINet type B FRNC	155
Industrial Ethernet PROFINet type B hybrid	156
Industrial Ethernet PROFINet type B SHIPLINE and FESTOON	157
Industrial Ethernet PROFINet type C PVC and PUR	158
Industrial Ethernet PROFINet type C Torsion	159
<b>Profibus DP</b>	
Profibus L2, fixed installation indoor	160
Profibus L2, fixed installation outdoor and robust	161
Profibus L2, direct burial PVC/PE and armoured	162
Profibus L2, 7-wire	163
Profibus L2, 105°C, 200°C and PH120	164
Profibus L2, Drag chain	166
Profibus ET200X, Profibus ECOFAST	167
Profibus, SHIPLINE and high temperature	168
Profibus Hybrid, DESINA®	169
Profibus L2, Torsion and Festoon	170
<b>Profibus PA</b>	
Profibus PA	171
Profibus PA, armoured	172
Profibus PA, Long Distance	173
<b>Profibus DP SK</b>	
Profibus SK, indoor and outdoor	174
Profibus SK FRNC and Robust (PUR)	175
Profibus SK FRNC PH120	176
Profibus SK, Drag chain	177
<b>FOUNDATION™ Fieldbus</b>	
FOUNDATION™ Fieldbus FF type A, Basic	178
FOUNDATION™ Fieldbus FF type A, with device ground	179
FOUNDATION™ Fieldbus FF type A, with device ground and armouring	180
FOUNDATION™ Fieldbus FF type A, without device ground	181

# BUS-CABLES

Designation	Page
<b>HMCB Bus cables for digital encoder cable</b>	
Bus Cable HMCB200, PVC	182
Bus Cable HMCB500S, PVC, Drag chain	183
Bus Cable HMCB800W, PUR, Drag chain	184
<b>USB</b>	
Bus Cable USB S 2.0, PUR, highflexible	185
Bus Cable USB L 2.0, PUR, highflexible	186
Bus Cable USB 3.0, PUR, highflexible	187
<b>FireWire™</b>	
FireWire™ PUR, Drag chain	188
<b>Koax Drag chain</b>	
Bus Cable Koax PUR, Drag chain, 50 Ohm	189
<b>CAN Bus</b>	
CAN-Bus 0,22 mm <sup>2</sup> , flexible	190
CAN Bus 0,22 mm <sup>2</sup> (pair stranded), flexible	191
CAN-Bus 0,25 mm <sup>2</sup> , flexible, 105°C	192
CAN-Bus 0,34 mm <sup>2</sup> , flexible	193
CAN-Bus 0,34 mm <sup>2</sup> , (pair stranded) flexible	194
CAN-Bus 0,50 mm <sup>2</sup> , flexible	195
CAN-Bus 0,50 mm <sup>2</sup> , (pair stranded), flexible	196
CAN-Bus 0,50 mm <sup>2</sup> , direct burial	197
CAN-Bus 0,75 mm <sup>2</sup> , flexible	198
CAN-Bus 0,25 mm <sup>2</sup> , Drag chain	199
CAN-Bus 0,34 mm <sup>2</sup> Drag chain	200
CAN-Bus 0,5 mm <sup>2</sup> , Drag chain	201
<b>Interbus</b>	
Interbus fixed installation, remote bus and installation remote bus	202
Interbus fixed installation, remote bus halogen-free	203
Interbus Drag chain, remote bus and installation remote bus	204
<b>Multibus</b>	
Multibus I	205
Multibus II	206
<b>AS-Interface</b>	
ASI-Bus, EPDM	207
ASI-Bus Long Distance, EPDM	208
ASI-Bus, PUR, highflexible, UL/CSA	209
ASI-Bus Long Distance PUR, highflexible, UL/CSA	210
ASI-Bus, TPE 105°C, CMG	211
ASI-Bus, TPE	212
AS-Interface electrical cabinets, FLIH	213
<b>DeviceNet™</b>	
DeviceNet™, PVC, fixed installation	214
DeviceNet™, FRNC, fixed installation	215
DeviceNet™, CPE, fixed installation	216
DeviceNet™ PUR, highflexible	217
<b>CC-Link</b>	
CC-Link-Bus	218
<b>SafetyBus</b>	
SafetyBus p, FRNC and PUR	219
<b>LON</b>	
LON BUS, H122 and Y116	220
LON BUS, Y118 and H118	221
LON BUS, H116	222
<b>MOD-Bus</b>	
MOD-Bus, PVC, armoured	223
<b>EIB</b>	
KNX/EIB-Bus, 4-cores PVC	224
KNX/EIB-Bus, 4-cores FRNC and 4-cores PVC	225
KNX/EIB-Bus, 4-cores, direct burial	226
<b>Hospital-Bus</b>	
KH-Bus, PVC and FRNC	227

# Industrial Ethernet

ROBUST

**HELUKAT®** 600IND

S/FTP, Category 7e

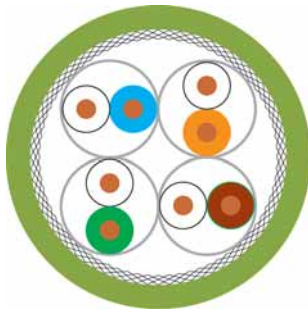

## Type

### Cable structure

Inner conductor diameter:  
Core insulation:  
Core colours:  
Stranding element:  
Separator:  
Shielding 1:  
Screen 1 over stranding:  
Screen 2 over stranding:  
Outer sheath material:  
Cable external diameter:  
Outer sheath colour:

## Industrial Area

### S/FTP 4x2xAWG 23/1 PUR

Copper, bare (AWG 23/1)  
Foam-skin-PE  
wh/bu, wh/og, wh/gn, wh/bn  
Double core  
-  
Al-Foil  
Cu braid  
-  
PUR  
app. 7,8 mm  
Green similar to RAL 6018

## Electrical data

Characteristic impedance: 100 Ohm  $\pm$  15 Ohm at 1 to 100 MHz  
100 Ohm  $\pm$  20 Ohm at 101 to 1200 MHz  
Loop resistance: 149 Ohm/km max.  
Mutual capacitance: 43 nF/km nom.  
Relative propagation velocity: 77 %

## Typical values

frequency (MHz)	10	16	62,5	100	250	350	600	900	1000	1200
attenuation (db/100m)	5,6	7,0	13,8	17,6	28,3	34,0	45,2	57,1	60,8	66,0
next (db)	95,0	95,0	89,0	87,0	82,0	79,0	74,0	70,0	66,0	63,0
ACR (db)	89,4	88,0	75,2	69,4	53,7	43,0	27,8	13,9	5,2	-3,0

## Technical data

Weight: app. 68 kg/km  
bending radius, repeated: 78 mm  
Operating temperature range min.: -40°C  
Operating temperature range max.: +80°C  
Caloric load, approx. value: 0,74 MJ/m  
Copper weight: 34,00 kg/km

## Norms

Acc. to ISO/IEC 11801, Acc. to EN 50173, Acc. to EIA/TIA 568-A, Category 7e, Flame-retardant acc. to IEC 60332-1-2, Halogen-free acc. to 60754-2, Oil-resistant

## Application

HELUKAT® 600IND Category 7e Robust is used for harsh industrial environments. Mechanically, this product exhibits excellent resistance to mineral oils, greases and cooling lubricants and has good microbe and hydrolysis resistance. Electrically, this cable is characterized by high reserve capacity and outstanding performance. This allows you to create services such as Gigabit Ethernet, Fast Ethernet, Ethernet, ATM155, FDDI, Token Ring 4/16 Mbit/s or ISDN without difficulty. These cables considerably exceed the requirement for compliance with Class B interference emission to EN55022, as well as interference immunity to EN55024. This gives the series outstanding EMC characteristics.

## Part no.

**801197**, S/FTP 4x2xAWG 23/1 PUR (S-STP)

Dimensions and specifications may be changed without prior notice.

# Industrial Ethernet

ROBUST

**HELUKAT®** 1200IND

S/FTP, Category 7<sub>A</sub>

NEW

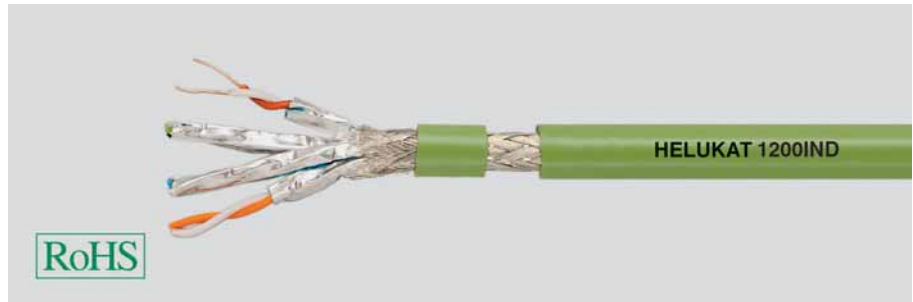
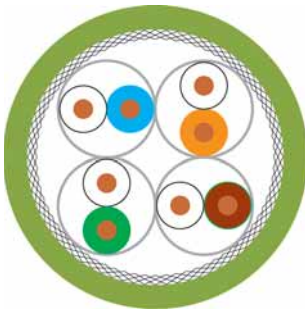

## Cable structure

Inner conductor Ø:	0,57 mm
Conductor material:	Copper, bare
Core insulation:	Foam-skin-PE
Core colours:	wh/bu, wh/og, wh/gn, wh/bn
Separator:	-
Screen over stranding element:	Al-Foil
Screen 1 over stranding:	Cu braid
Screen 2 over stranding:	-
Outer sheath material:	PUR
Outer diameter:	app. 7,8 mm
Outer sheath colour:	Green similar to RAL 6018

## Electrical data

Characteristic impedance:	100 Ohm ± 15 Ohm at 1 to 100 MHz 100 Ohm ± 20 Ohm at 101 to 1200 MHz
Loop resistance:	149 Ohm/km max.
Mutual capacitance:	43 nF/km nom.

## Typical values

frequency (MHz)	10	16	62,5	100	250	350	600	900	1200
attenuation (dB/100m)	5,6	7,0	13,8	17,6	28,3	34,0	45,2	57,1	66
Next (dB)	95,0	95,0	89,0	87,0	82,0	89,0	74,0	70,0	63,0
PS-ACR (dB)	89,4	86,0	73,2	67,4	51,7	43,0	27,8	13,9	1,0

## Technical data

Weight:	app. 68 kg/km
Operating temperature range min.:	-40°C
Operating temperature range max.:	+80°C
Caloric load, approx. value:	0,76 MJ/m
Copper weight:	37,00 kg/km

## Norms

Acc. to ISO/IEC 11801, Acc. to EN 50173, Acc. to EIA/TIA 568-A, Category 7<sub>A</sub>, Flame-retardant acc. to IEC 60332-1-2, Halogen-free acc. to 60754-2, Oil-resistant

## Application

HELUKAT® 1200IND Category 7<sub>A</sub> Robust is used for harsh industrial environments. Mechanically, this product exhibits excellent resistance to mineral oils, greases and cooling lubricants and has good microbe and hydrolysis resistance. Electrically, this cable is characterized by high reserve capacity and outstanding performance.

## Part no.

**805680**, S/FTP 4x2xAWG 23/1 PUR (S-STP)

Dimensions and specifications may be changed without prior notice.

# Industrial Ethernet

ROBUSTFLEX

**HELUKAT®** 1000IND

S/FTP, Category 7<sub>A</sub>

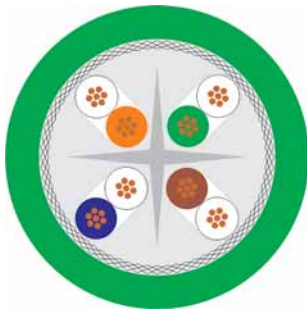

NEW

## Cable structure

Inner conductor Ø:	0,48 mm
Conductor material:	Copper, bare
Core insulation:	Foam-skin-PE
Core colours:	wh/bu, wh/og, wh/gn, wh/bn
Separator:	-
Screen over stranding element:	Al-Foil
Screen 1 over stranding:	Cu braid
Screen 2 over stranding:	-
Outer sheath material:	PUR
Outer diameter:	app. 6,2 mm
Outer sheath colour:	Green similar to RAL 6018

## S/FTP 4x2xAWG 26/7 PUR

## Electrical data

Characteristic impedance:	100 Ohm ± 15 Ohm at 1 to 100 MHz 100 Ohm ± 20 Ohm at 101 to 1000 MHz
Loop resistance:	290 Ohm/km max.
Mutual capacitance:	44 nF/km nom.
Rel. propagation velocity:	64 %

## Typical values

Frequenz (MHz)	10	100	250	800	900	1000
Dämpfung (dB/10m)	0,9	2,8	4,5	8,2	8,8	9,3
Next (dB)	78,0	78,0	72,4	64,9	64,1	63,4
ACR (dB)	25,0	19,0	15,6	15,6	15,6	15,6

## Technical data

Weight:	app. 40 kg/km
bending radius, repeated:	50 mm
Operating temperature range min.:	-25°C
Operating temperature range max.:	+80°C
Caloric load, approx. value:	0,45 MJ/m
Copper weight:	23,00 kg/km

## Norms

Acc. to ISO/IEC 11801, Acc. to EN 50173, Acc. to EIA/TIA 568-A, Category 7<sub>A</sub>, Flame-retardant acc. to IEC 60332-1-2, Halogen-free acc. to 60754-2, Oil-resistant, AWM 20963 (80°C/30V)

## Application

HELUKAT®1000IND Category 7<sub>A</sub> Robustflex is an Ethernet cable that, thanks to use of a halogen-free PU outer sheath, is ideal for harsh industrial surroundings. This cable is configurable with common RJ45 plugs (industrial and office version), as well as with some Sub-D and M12 plugs.

## Part no.

**805684**, S/FTP 4x2xAWG 26/7 PUR (S-STP)

Dimensions and specifications may be changed without prior notice.

# Industrial Ethernet

Drag Chain

**HELUKAT® 600S**

SF/FTP, Category 7

NEW



## Cable structure

Inner conductor Ø:	0,6 mm
Conductor material:	Copper, bare
Core insulation:	Foam-skin-PE
Core colours:	wh/bu, wh/og, wh/gn, wh/bn
Separator:	-
Screen over stranding element:	Al-Foil
Screen 1 over stranding:	Al-Foil
Screen 2 over stranding:	Cu braid
Outer sheath material:	PUR
Outer diameter:	app. 8,7 mm
Outer sheath colour:	Green similar to RAL 6018

## SF/FTP 4x2xAWG 24/7 (stranded) PUR

## Electrical data

Characteristic impedance:	100 Ohm ± 15 Ohm at 1 to 100 MHz 100 Ohm ± 20 Ohm at 101 to 600 MHz
Loop resistance:	175 Ohm/km max.

## Typical values

frequency (MHz)	10	16	62,5	100	200	300	600
attenuation (db/100m)	6,7	8,5	17,4	22,1	31,6	39,2	57,4
next (db)	78	78	75,5	72,4	67,9	65,2	60,7
ACR (db)	71,3	69,5	58,1	50,3	36,3	26	3,3

## Technical data

Weight:	app. 95 kg/km
bending radius, repeated:	131 mm
Operating temperature range min.:	-30°C
Operating temperature range max.:	+70°C
Copper weight:	46,00 kg/km

## Norms

Acc. to ISO/IEC 11801, Acc. to EIA/TIA 568-A, Category 7, Flame-retardant acc. to IEC 60332-1-2, Halogen-free acc. to 60754-2, Oil-resistant, CMX 75°C (shielded)

## Application

HELUKAT® 600S Category 7 Trailing Cable is designed for use in cable carriers and the recurring loads caused by moving machine components. It provides excellent transmission characteristics under extremely difficult conditions.

## Part no.

**805614**, SF/FTP 4x2xAWG 24/7 PUR

Dimensions and specifications may be changed without prior notice.

# Industrial Ethernet

SHIPLINE

**HELUKAT® 600IND**

S/FTP, Category 7

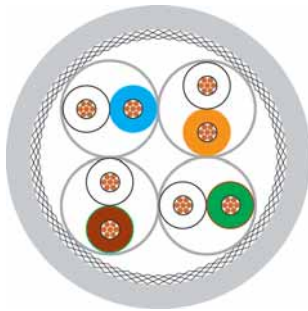

## Type

### Cable structure

Inner conductor diameter:  
Core insulation:  
Core colours:  
Stranding element:  
Separator:  
Shielding 1:  
Screen 1 over stranding:  
Screen 2 over stranding:  
Outer sheath material:  
Cable external diameter:  
Outer sheath colour:

## Marine and Offshore

### S/FTP 4x2xAWG 24/7 (stranded) FRNC

Copper, bare (AWG 24/7)  
Foam-skin-PE  
wh/bu, wh/og, wh/gn, wh/bn  
Double core  
-  
Al-Foil  
Cu braid  
-  
FRNC  
app. 9,1 mm ± 0,3 mm  
Grey similar to RAL 7035

## Electrical data

Characteristic impedance: 100 Ohm ± 15 Ohm at 1 to 100 MHz  
100 Ohm ± 20 Ohm at 101 to 600 MHz  
Loop resistance: 168 Ohm/km max.  
Mutual capacitance: 43 nF/km nom.  
Relative propagation velocity: 72 %

## Typical values

Frequency (MHz)	10	16	62,5	100	200	600
Attenuation (dB/10m)	0,7	0,8	1,6	2,1	3,1	5,2
Next (dB)	90,0	90,0	85,0	81,0	76,0	68,0
ACR (dB)	89,3	89,2	83,4	78,9	72,9	62,8

## Technical data

Weight: app. 85 kg/km  
bending radius, repeated: 85 mm  
Operating temperature range min.: -20°C  
Operating temperature range max.: +75°C  
Caloric load, approx. value: 0,80 MJ/m  
Copper weight: 36,00 kg/km

## Norms

Acc. to ISO/IEC 11801, Acc. to EN 50173, Acc. to EIA/TIA 568-A, Category 7, Flame-retardant acc. to IEC 60332-3, Smoke density acc. to IEC 61034, Halogen-free acc. to 60754-2, Corrosiveness acc. to EN50267-2-3, Oil-resistant

## Application

HELUKAT® 600IND Category 7 Shipline is designed specially for use in shipbuilding and exceptionally well-suited for Ethernet applications. It guarantees excellent transmission characteristics and may be used even under the harshest conditions. The cable listed here is certified by **German Lloyd**; this means it is designed for flexible marine and offshore applications.

## Part no.

**803382**, S/FTP 4x2xAWG 24/7 stranded FRNC (S-STP)

Dimensions and specifications may be changed without prior notice.

# Industrial Ethernet

ROBUSTFLEX

**HELUKAT® 600IND**

S/FTP, Category 7



## Type

### Cable structure

Inner conductor diameter:  
Core insulation:  
Core colours:  
Stranding element:  
Separator:  
Shielding 1:  
Screen 1 over stranding:  
Screen 2 over stranding:  
Outer sheath material:  
Cable external diameter:  
Outer sheath colour:

## Industrial Patch Cables

### S/FTP 4x2xAWG 26/7 PUR

Copper, bare (AWG 26/7)  
Foam-skin-PE  
wh/bu, wh/og, wh/gn, wh/bn  
Double core  
-  
Al-Foil  
Cu braid  
-  
PUR  
app. 6,4 mm ± 0,3 mm  
Green similar to RAL 6018

## Electrical data

Characteristic impedance:  
  
Loop resistance:  
Mutual capacitance:  
Relative propagation velocity:

100 Ohm ± 15 Ohm at 1 to 100 MHz  
100 Ohm ± 20 Ohm at 101 to 600 MHz  
290 Ohm/km max.  
42 nF/km nom.  
64 %

## Typical values

Frequenz (MHz)	10	16	62,5	100	200	600
Dämpfung (dB/100m)	8,4	10,4	20,5	26,2	38	67,8
PS Next (dB)	95	95	90	90	85	73
PS ACR (dB)	86,6	84,6	69,5	63,8	47,0	5,2

## Technical data

Weight: app. 48 kg/km  
bending radius, repeated: 64 mm  
Operating temperature range min.: -40°C  
Operating temperature range max.: +80°C  
Caloric load, approx. value: 0,45 MJ/m  
Copper weight: 28,00 kg/km

## Norms

Acc. to ISO/IEC 11801, Acc. to EN 50173, Acc. to EIA/TIA 568-A, Category 7, Flame-retardant acc. to IEC 60332-1-2, Halogen-free acc. to 60754-2, Oil-resistant, AWM 20963 (80°C/30V)

## Application

HELUKAT®600IND Category 7 Robustflex is an Ethernet cable that is ideal for harsh industrial surroundings thanks to use of a halogen-free PU outer sheath. This cable is configurable with common RJ45 plugs (industrial and office version), as well as with some Sub-D and M12 plugs.

## Part no.

**802184**, S/FTP 4x2xAWG 26/7 PUR (S-STP)

Dimensions and specifications may be changed without prior notice.



# Industrial Ethernet

10GIG

**HELUKAT®** 500IND

S/FTP, Category 6A

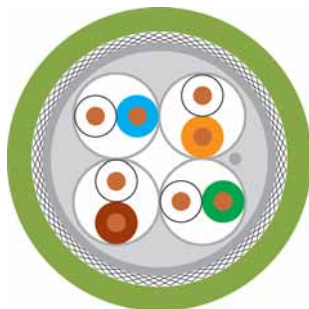

## Type

### Cable structure

Inner conductor diameter:  
Core insulation:  
Core colours:  
Stranding element:  
Separator:  
Inner sheath material:  
Shielding 1:  
Total shielding:  
Drain wire:  
Outer sheath material:  
Cable external diameter:  
Outer sheath colour:

## Industrial Area

### S/FTP 4x2xAWG 22/1

Copper, bare (AWG 22/1)  
Foam-skin-PE  
wh/bu, wh/og, wh/gn, wh/bn  
Double core  
-  
FRNC  
Al-Foil  
AL-Foil + braid  
yes  
PVC  
app. 9,6 mm ± 0,3 mm  
Green similar to RAL 6018

## Electrical data

Characteristic impedance:  
Conductor resistance, max.:  
Insulation resistance, min.:  
Loop resistance:  
Mutual capacitance:  
Test voltage:  
Relative propagation velocity:

100 Ohm ± 15 Ohm at 1 to 100 MHz  
100 Ohm ± 20 Ohm at 101 to 500 MHz  
59 Ohm/km  
0,5 GOhm x km  
118 Ohm/km max.  
72 nF/km nom.  
0,7 kV  
62 %

## Typical values

Frequency (MHz)	10	16	62,5	100	250	500
Attenuation (dB/100m)	5,9	7,5	15,0	19,1	31,1	45,3
Next (dB)	60,3	57,2	48,4	45,3	39,3	34,8
PSNext (dB)	57,3	54,2	45,4	42,3	36,3	31,8

## Technical data

Weight: app. 115 kg/km  
bending radius, repeated: 80 mm  
Operating temperature range min.: -20°C  
Operating temperature range max.: +60°C  
Caloric load, approx. value: 1,63 MJ/m  
Copper weight: 44,00 kg/km

## Norms

Acc. to ISO/IEC 11801, Acc. to EN 50173, Acc. to EIA/TIA 568-A, Category 6A, CMG FT4

## Application

HELUKAT® 500IND was designed specially for extreme industrial applications for fixed installation. The copper data cable is especially well-suited for **Category 6A 10 Gigabit/500MHz (IEC 61156-5)** Ethernet applications. It guarantees excellent transmission characteristics and may be used even under the harshest conditions.

## Part no.

**803693**, INDUSTRIAL ETHERNET KAT.6A 10GIG PVC

Dimensions and specifications may be changed without prior notice.

# Industrial Ethernet

Drag Chain PVC + PUR

**HELUKAT® 500S**

S/FTP, Category 6A

NEW



## Type

### Cable structure

Inner conductor diameter:  
 Core insulation:  
 Core colours:  
 Stranding element:  
 Separator:  
 Shielding 1:  
 Total shielding:  
 Outer sheath material:  
 Cable external diameter:  
 Outer sheath colour:

### Drag Chain applications S/FTP 4x2xAWG 24/7

Copper, bare (AWG 24/7)  
 PE  
 wh/bu, wh/og, wh/gn, wh/bn  
 Double core  
 Polyester foil over stranded bundle  
 Al-Foil  
 Cu braid, tinned  
 PVC  
 app. 8,9 mm ± 0,2 mm  
 Green similar to RAL 6018

### Drag Chain applications S/FTP 4x2xAWG 24/7

Copper, bare (AWG 24/7)  
 PE  
 wh/bu, wh/og, wh/gn, wh/bn  
 Double core  
 Polyester foil over stranded bundle  
 Al-Foil  
 Cu braid, tinned  
 PUR  
 app. 8,9 mm ± 0,2 mm  
 Green similar to RAL 6018

## Electrical data

Characteristic impedance:  
 Insulation resistance, min.:  
 Mutual capacitance:  
 Test voltage:  
 Relative propagation velocity:

100 Ohm ± 15 Ohm at 1 to 100 MHz  
 100 Ohm ± 20 Ohm at 101 to 500 MHz  
 0,5 GOhm x km  
 50 nF/km nom.  
 0,7 kV  
 67 %

100 Ohm ± 15 Ohm at 1 to 100 MHz  
 100 Ohm ± 20 Ohm at 101 to 500 MHz  
 0,5 GOhm x km  
 50 nF/km nom.  
 0,7 kV  
 67 %

## Typical values

frequency (MHz)	10	16	62,5	100	200	300	500
attenuation (db/100m)	8,9	11,2	22,5	28,7	41,4	51,4	67,9
next (dB)	60,3	57,2	48,4	45,3	40,8	38,1	34,8

## Technical data

Weight: app. 76 kg/km  
 bending radius, repeated: 135 mm  
 Operating temperature range min.: -10°C  
 Operating temperature range max.: +80°C  
 Caloric load, approx. value: 1,69 MJ/m  
 Copper weight: 44,00 kg/km

app. 76 kg/km  
 135 mm  
 -40°C  
 +80°C  
 1,69 MJ/m  
 44,00 kg/km

## Norms

Acc. to ISO/IEC 11801, Acc. to EN 50173, Acc. to EIA/TIA 568-A, Category 6A, CM 75°C or PLTC

## Application

HELUKAT® 500S was designed specially for flexible applications in Drag Chains in extreme industrial environments. The copper data cable is especially well-suited for Category 6A Ethernet applications. It guarantees excellent transmission characteristics and may be used even under the harshest conditions.

The PVC version has UL CM + PLTC listing; the PUR version UL recognized and additional halogen free

## Part no.

**805704**, INDUSTRIAL ETHERNET KAT.6A  
10GIG PVC

**805703**, INDUSTRIAL ETHERNET KAT.6A  
10GIG PUR

Dimensions and specifications may be changed without prior notice.

# Industrial Ethernet

Drag Chain

**HELUKAT® 500S**

S/FTP, Category 6A

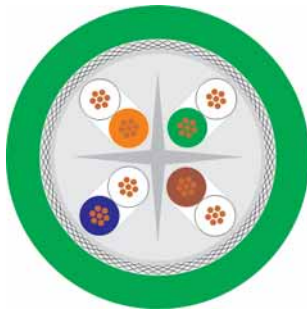

NEW

## Cable structure

Inner conductor Ø:	0,55 mm
Conductor material:	Copper, tinned
Core insulation:	Foam-skin-PE
Core colours:	wh/bu, wh/og, wh/gn, wh/bn
Separator:	-
Screen over stranding element:	Al-Foil
Total shielding:	AL-Foil + braid
Outer sheath material:	PUR
Outer diameter:	app. 7,8 mm
Outer sheath colour:	Green similar to RAL 6018

## Electrical data

Characteristic impedance:	100 Ohm ± 15 Ohm at 1 to 100 MHz 100 Ohm ± 20 Ohm at 101 to 500 MHz
Conductor resistance, max.:	55,4 Ohm/km
Insulation resistance, min.:	5 GOhm x km
Loop resistance:	110 Ohm/km max.
Mutual capacitance:	50 nF/km nom.
Test voltage:	0,7 kV

## Typical values

Frequency (MHz)	10	16	62,5	100	300	500
Attenuation (dB/10m)	0,9	1,1	2,3	2,9	5,1	6,8
Next (dB)	60,3	57,2	48,4	45,3	38,1	34,8

## Technical data

Weight:	app. 64 kg/km
bending radius, repeated:	117 mm
Operating temperature range min.:	-10°C
Operating temperature range max.:	+70°C
Caloric load, approx. value:	1,35 MJ/m
Copper weight:	34,00 kg/km

## Norms

Acc. to ISO/IEC 11801, Acc. to EN 50173, Acc. to EIA/TIA 568-A, Category 6A, Flame-retardant acc. to IEC 60332-1-2, Halogen-free acc. to 60754-2, CMX 75°C (shielded)

## Application

HELUKAT® 500S trailing cable Category 6A is designed for use in cable carriers and the recurring loads caused by moving machine components. It provides excellent transmission characteristics under extremely difficult conditions.

## Part no.

**805548**, INDUSTRIAL ETHERNET CAT.6A 10GIG PUR

Dimensions and specifications may be changed without prior notice.

# Industrial Ethernet

PVC CMG

**HELUKAT®** 250IND

SF / UTP, Category 6

NEW



## Cable structure

Inner conductor Ø:	0,51 mm
Conductor material:	Copper, bare
Core insulation:	Foam-skin-PE
Core colours:	wh/bu, wh/og, wh/gn, wh/bn
Separator:	Polyester foil over stranded bundle
Inner sheath material:	FRNC
Screen over stranding element:	-
Total shielding:	AL-Foil + braid
Outer sheath material:	PVC
Outer diameter:	app. 8,0 mm
Outer sheath colour:	Green similar to RAL 6018

## Electrical data

Characteristic impedance:	100 Ohm ± 15 Ohm at 1 to 100 MHz 100 Ohm ± 20 Ohm bei 101 bis 250 MHz
Conductor resistance, max.:	85 Ohm/km
Insulation resistance, min.:	0,5 GOhm x km
Loop resistance:	190 Ohm/km max.
Mutual capacitance:	72 nF/km nom.
Test voltage:	0,7 kV
Rel. propagation velocity:	62 %

## Typical values

Frequenz (MHz)	10	16	62,5	100	250
attenuation (dB/100m)	6,3	7,9	16,0	20,7	35,0
Next (dB)	59,3	56,2	47,4	44,3	38,3
PSNext (dB)	57,3	54,2	45,4	42,3	36,3

## Technical data

Weight:	app. 76 kg/km
bending radius, repeated:	40 mm
Operating temperature range min.:	-40°C
Operating temperature range max.:	+80°C
Caloric load, approx. value:	1,69 MJ/m
Copper weight:	37,00 kg/km

## Norms

Acc. to ISO/IEC 11801, Acc. to EN 50173, Acc. to EIA/TIA 568-A, Category 6, Flame-retardant acc. to IEC 60332-3, CMG FT4

## Application

HELUKAT® 250IND was designed specially for extreme industrial applications. The copper data cable is especially well-suited for Ethernet applications Category 6. It guarantees excellent transmission characteristics and may be used even under the harshest conditions.

## Part no.

**805655**, INDUSTRIAL ETHERNET CAT.6

Dimensions and specifications may be changed without prior notice.

# Industrial Ethernet

PVC AWM

**HELUKAT® 250IND**

SF / UTP, Category 6



NEW

## Cable structure

Inner conductor Ø:  
Conductor material:  
Core insulation:  
Core colours:  
Separator:  
Inner sheath material:  
Screen over stranding element:  
Total shielding:  
Outer sheath material:  
Outer diameter:  
Outer sheath colour:

## SF/UTP 4x2xAWG 24/1

0,52 mm  
Copper, bare  
PE  
wh/bu, wh/og, wh/gn, wh/bn  
-  
FRNC  
-  
AL-Foil + braid  
PVC  
app. 8,0 mm  
Green similar to RAL 6018

## Electrical data

Characteristic impedance: 100 Ohm ± 15 Ohm at 1 to 100 MHz  
100 Ohm ± 20 Ohm bei 101 bis 250 MHz  
Insulation resistance, min.: 0,5 GOhm x km  
Mutual capacitance: 72 nF/km nom.  
Test voltage: 0,7 kV  
Rel. propagation velocity: 62 %

## Typical values

Frequency (MHz)	10	16	62,5	100	250
Attenuation (dB/100m)	5,9	7,5	15,0	19,1	31,1
Next (dB)	60,3	57,2	48,4	45,3	39,3
PSNext (dB)	57,3	54,2	45,4	42,3	36,3

## Technical data

Weight: app. 78 kg/km  
bending radius, repeated: 40 mm  
Operating temperature range min.: -40°C  
Operating temperature range max.: +80°C  
Caloric load, approx. value: 1,69 MJ/m  
Copper weight: 40,00 kg/km

## Norms

Acc. to ISO/IEC 11801, Acc. to EN 50173, Acc. to EIA/TIA 568-A, Category 6, Flame-retardant acc. to IEC 60332-3, UL Style 2571

## Application

HELUKAT® 250IND was designed specially for extreme industrial applications. The copper data cable is especially well-suited for Category 6 Ethernet applications. It guarantees excellent transmission characteristics and may be used even under the harshest conditions. This version with PVC jacket is designed specifically for fixed installation under difficult industrial conditions.

## Part no.

**805681**, INDUSTRIAL ETHERNET CAT.6

Dimensions and specifications may be changed without prior notice.

# Industrial Ethernet

Drag Chain PVC

**HELUKAT® 250S**

SF / UTP, Category 6

NEW



## Cable structure

Inner conductor Ø:  
Conductor material:  
Core insulation:  
Core colours:  
Separator:  
Inner sheath material:  
Screen over stranding element:  
Total shielding:  
Outer sheath material:  
Outer diameter:  
Outer sheath colour:

## SF/UTP 4x2xAWG 24/7

0,6 mm  
Copper, bare  
Foam-skin-PE  
whbu/bu, whog/og, whgn/gn, whbn/bn  
Polyester foil over stranded bundle  
FRNC  
-  
AL-Foil + braid  
PVC  
app. 8,0 mm  
Green similar to RAL 6018

## Electrical data

Characteristic impedance:  
Conductor resistance, max.:  
Insulation resistance, min.:  
Loop resistance:  
Mutual capacitance:  
Test voltage:  
Rel. propagation velocity:

100 Ohm ± 15 Ohm at 1 to 100 MHz  
100 Ohm ± 20 Ohm bei 101 bis 250 MHz  
90 Ohm/km  
0,5 GOhm x km  
180 Ohm/km max.  
50 nF/km nom.  
0,7 kV  
67 %

## Typical values

Frequency (MHz)	10	16	62,5	100	200	250
Attenuation (db/100m)	5,8	11,4	23,2	29,9	43,7	49,5
Next (dB)	59,3	56,2	47,4	44,3	39,8	38,3
PSNext (dB)	57,3	54,2	45,4	42,3	37,8	36,3

## Technical data

Weight:  
bending radius, repeated:  
Operating temperature range min.:  
Operating temperature range max.:  
Caloric load, approx. value:  
Copper weight:

app. 72 kg/km  
160 mm  
-5°C  
+50°C  
1,69 MJ/m  
39,00 kg/km

## Norms

Acc. to ISO/IEC 11801, Acc. to EN 50173, Acc. to EIA/TIA 568-A, Category 6, Flame-retardant acc. to IEC 60332-3, CMG FT4

## Application

HELUKAT® 250S was designed specially for extreme industrial applications. The copper data cable is especially well-suited for Category 6 Ethernet applications. It guarantees excellent transmission characteristics and may be used even under the harshest conditions. This version with PVC jacket and stranded conductor is designed specifically for trailing use under difficult industrial conditions.

## Part no.

**805658**, INDUSTRIAL ETHERNET CAT.6

Dimensions and specifications may be changed without prior notice.

# Industrial Ethernet

Drag Chain PUR

**HELUKAT® 250S**

SF/UTP, Category 6

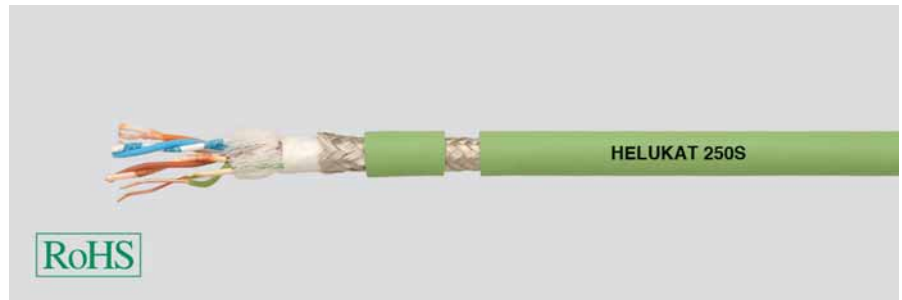

## Type

### Cable structure

Inner conductor diameter:  
Core insulation:  
Core colours:  
Stranding element:  
Separator:  
Inner sheath material:  
Shielding 1:  
Total shielding:  
Outer sheath material:  
Cable external diameter:  
Outer sheath colour:

## Drag Chain applications

### SF/UTP 4x2x0.15 mm<sup>2</sup> (stranded) PUR

Copper, tinned (AWG 26/19)  
PP  
whbu/bu, whog/og, whgn/gn, whbn/bn  
Double core  
-  
FRNC  
-  
AL-Foil + braid  
PUR  
app. 7,8 mm ± 0,2 mm  
Green similar to RAL 6018

## Electrical data

Characteristic impedance: 100 Ohm ± 15 Ohm at 1 to 100 MHz  
100 Ohm ± 20 Ohm bei 101 bis 250 MHz  
Conductor resistance, max.: 140 Ohm/km  
Insulation resistance, min.: 5 GOhm x km  
Loop resistance: 280 Ohm/km max.  
Mutual capacitance: 50 nF/km nom.  
Test voltage: 0,7 kV  
Relative propagation velocity: 67 %

## Typical values

Frequency (MHz)	10	16	62,5	100	250
Attenuation (dB/10m)	0,9	1,2	2,4	2,9	4,9
Next (dB)	60,3	57,2	48,4	45,3	39,3
ACR (dB)	59,4	56,0	46,0	42,4	34,4

## Technical data

Weight: app. 63 kg/km  
bending radius, repeated: 60 mm  
Operating temperature range min.: -30°C  
Operating temperature range max.: +70°C  
Caloric load, approx. value: 1,35 MJ/m  
Copper weight: 34,00 kg/km

## Norms

Acc. to ISO/IEC 11801, Acc. to EN 50173, Acc. to EIA/TIA 568-A, Category 6, Flame-retardant acc. to IEC 60332-1-2, Halogen-free acc. to 60754-2, CMX 75°C (shielded)

## Application

HELUKAT® 250S trailing cable Category 6 is designed for use in cable carriers and the recurring loads caused by moving machine components. It provides excellent transmission characteristics under extremely difficult conditions.

## Part no.

**803387**, INDUSTRIAL ETHERNET CAT.6

Dimensions and specifications may be changed without prior notice.

# Industrial Ethernet

FRNC + PUR

**HELUKAT**<sup>®</sup> 100IND

SF/UTP, Category 5e

NEW



## Type

### Cable structure

Inner conductor diameter:  
Core insulation:  
Core colours:  
Stranding element:  
Separator:  
Shielding 1:  
Total shielding:  
Outer sheath material:  
Cable external diameter:  
Outer sheath colour:

### Fixed installation, indoor SF/UTP 2x2xAWG24/ 1

Copper, bare (AWG 24/1)  
Foam-skin-PE  
wsor/or, wsgn/gn  
Double core  
Polyester foil over stranded bundle  
Al-Foil  
AL-Foil + braid  
FRNC  
app. 5,6 mm ± 0,2 mm  
blau similar to RAL 5021

### Fixed installation, indoor SF/UTP 2x2xAWG24/ 1

Copper, bare (AWG 24/1)  
Foam-skin-PE  
wsor/or, wsgn/gn  
Double core  
-  
-  
AL-Foil + braid  
PUR  
app. 5,6 mm ± 0,2 mm  
blau similar to RAL 5021

## Electrical data

Characteristic impedance:  
Conductor resistance, max.:  
Insulation resistance, min.:  
Loop resistance:  
Mutual capacitance:  
Nominal voltage:  
Test voltage:

100 Ohm ± 15 Ohm at 1 to 100 MHz  
86 Ohm/km  
0,5 GOhm x km  
192 Ohm/km max.  
48 nF/km nom.  
125 V  
1 kV

100 Ohm ± 15 Ohm at 1 to 100 MHz  
86 Ohm/km  
0,5 GOhm x km  
192 Ohm/km max.  
48 nF/km nom.  
125 V  
1 kV

## Typical values

frequency	(MHz)	10	16	62,5	100
attenuation	(dB/100m)	6,3	8,1	16,5	21,4
next	(dB)	50,3	47,4	38,4	35,3

## Technical data

Weight: app. 45 kg/km  
bending radius, repeated: 45 mm  
Operating temperature range min.: -30°C  
Operating temperature range max.: +80°C  
Copper weight: 22,00 kg/km

app. 53 kg/km  
45 mm  
-30°C  
+80°C  
22,00 kg/km

## Norms

Acc. to ISO/IEC 11801, Acc. to EN 50173, Category 5, Flame-retardant acc. to IEC 60332-3, Halogen-free acc. to 60754-2, Corrosiveness acc. to EN50267-2-3

## Application

HELUKAT<sup>®</sup> 100IND Category 5e FRNC for fixed installation indoor in halogen free and flame retardent edition.  
The PUR version is excellent oil resistant, halogen free and abrasion resistant.

## Part no.

**805699**, INDUSTRIAL ETHERNET CAT.5e

**805700**, INDUSTRIAL ETHERNET CAT.5e

Dimensions and specifications may be changed without prior notice.



# Industrial Ethernet

FLEX FRNC + PUR

**HELUKAT®** 100IND

SF/UTP, Category 5e

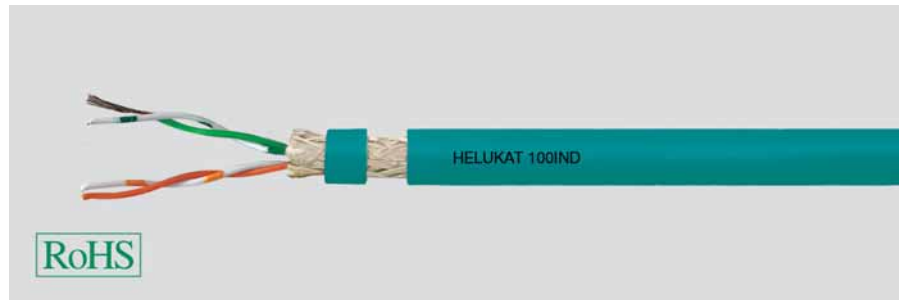
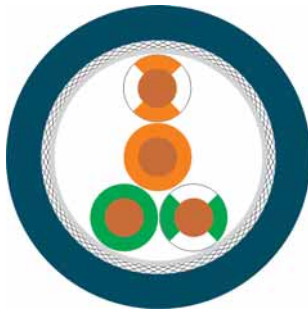

NEW

## Type Cable structure

Inner conductor diameter:  
Core insulation:  
Core colours:  
Stranding element:  
Separator:  
Shielding 1:  
Total shielding:  
Outer sheath material:  
Cable external diameter:  
Outer sheath colour:

## Mobile use SF/UTP 2x2xAWG26/7 (stranded)

Copper, bare (AWG 26/7)  
PE  
wsor/or, wsgn/gn  
Double core  
-  
-  
AL-Foil + braid  
FRNC  
app. 5,6 mm ± 0,2 mm  
blau similar to RAL 5021

## Mobile use SF/UTP 2x2xAWG26/7 (stranded)

Copper, bare (AWG 26/7)  
PE  
wsor/or, wsgn/gn  
Double core  
-  
PETP fleece  
AL-Foil + braid  
PUR  
app. 5,7 mm ± 0,2 mm  
blau similar to RAL 5021

## Electrical data

Characteristic impedance:  
Conductor resistance, max.:  
Insulation resistance, min.:  
Loop resistance:  
Mutual capacitance:  
Nominal voltage:  
Test voltage:  
Relative propagation velocity:

100 Ohm ± 15 Ohm at 1 to 100 MHz  
142 Ohm/km  
0,5 GOhm x km  
284 Ohm/km max.  
48 nF/km nom.  
125 V  
1 kV  
77 %

100 Ohm ± 15 Ohm at 1 to 100 MHz  
-  
-  
-  
50 nF/km nom.  
-  
0,5 kV  
67 %

## Typical values

Frequency (MHz)	10	16	62,5	100
Attenuation (dB/100m)	9,6	12,1	24,9	32,0
Next (dB)	50,3	47,2	38,4	35,3

## Technical data

Weight: app. 43 kg/km  
bending radius, repeated: 84 mm  
Operating temperature range min.: -5°C  
Operating temperature range max.: +60°C  
Caloric load, approx. value: 0,64 MJ/m  
Copper weight: 19,00 kg/km

app. 45 kg/km  
89 mm  
-5°C  
+60°C  
0,64 MJ/m  
19,00 kg/km

## Norms

Acc. to ISO/IEC 11801, Acc. to EN 50173, Acc. to EIA/TIA 568-A, Category 5e, Flame-retardant acc. to IEC 60332-1-2, Halogen-free acc. to 60754-2, Corrosiveness acc. to EN50267-2-3

## Application

HELUKAT® 100IND Category 5e FRNC flex is designed for flexible use. Thanks to the FRNC sheath, it also offers halogen free and flame retardent parameters.

The PUR version is excellent oil resistant, halogen free and abrasion resistant.

## Part no.

**805701**, INDUSTRIAL ETHERNET CAT.5e

**805702**, INDUSTRIAL ETHERNET CAT.5e

Dimensions and specifications may be changed without prior notice.

# Industrial Ethernet

ROBUSTFLEX

**HELUKAT**<sup>®</sup> 200IND

SF/UTP, Category 5e

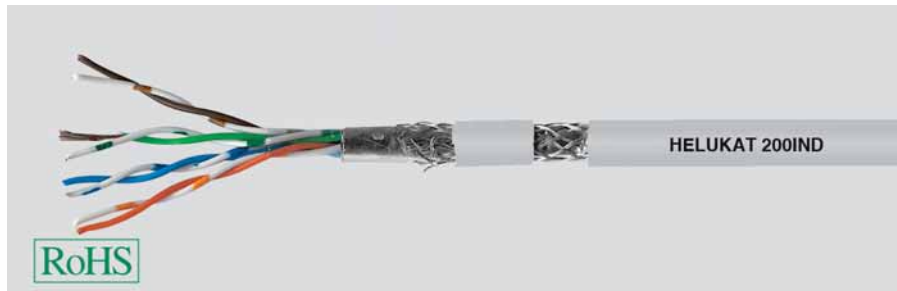
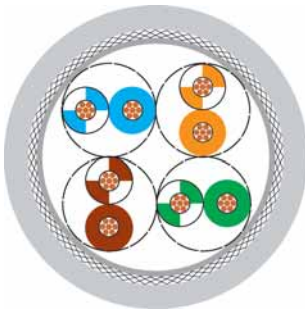

## Type

### Cable structure

Inner conductor diameter:  
Core insulation:  
Core colours:  
Stranding element:  
Separator:  
Shielding 1:  
Screen 1 over stranding:  
Screen 2 over stranding:  
Outer sheath material:  
Cable external diameter:  
Outer sheath colour:

## Industrial Patch Cables

### SF/UTP 4x2xAWG 26/7 PUR

Copper, bare (AWG 26/7)  
PO  
whbu/bu, whog/og, whgn/gn, whbn/bn  
Double core  
Polyester foil over stranded bundle  
-  
Al-Foil  
Cu braid  
PUR  
app. 5,8 mm  
Grey similar to RAL 7035

## Electrical data

Characteristic impedance:  
  
Loop resistance:  
Mutual capacitance:  
Relative propagation velocity:

100 Ohm  $\pm$  15 Ohm at 1 to 100 MHz  
100 Ohm  $\pm$  20 Ohm at 101 to 200 MHz  
260 Ohm/km max.  
47 nF/km nom.  
74 %

## Typical values

Frequency (MHz)	10	16	62,5	100	200
Attenuation (dB/10m)	0,8	1,1	2,4	2,9	4,3
Next (dB)	58,0	56,0	45,0	43,0	37,0
ACR (dB)	57,2	54,9	42,6	40,1	32,7

## Technical data

Weight: app. 44 kg/km  
bending radius, repeated: 46 mm  
Operating temperature range min.: -40°C  
Operating temperature range max.: +80°C  
Caloric load, approx. value: 0,54 MJ/m  
Copper weight: 24,00 kg/km

## Norms

Acc. to ISO/IEC 11801, Acc. to EN 50173, Acc. to EIA/TIA 568-A, Category 5e, Flame-retardant acc. to IEC 60332-1-2, Halogen-free acc. to 60754-2, Oil-resistant

## Application

HELUKAT<sup>®</sup> 200IND Category 5e Robustflex is used in harsh industrial surroundings and characterized by high reserve capacity and outstanding performance. Mechanically, the halogen-free PU outer sheath makes it ideal for harsh industrial surroundings. This cable is configurable with common RJ45 plugs (industrial and office version), as well as with various Sub-D and M12 plugs.

## Part no.

**800068**, SF/UTP 4x2xAWG 26/7 PUR (S-FTP)

Dimensions and specifications may be changed without prior notice.

# Industrial Ethernet

WK Industrial 105°C

**HELUKAT®** 100IND

SF/UTP, Category 5e

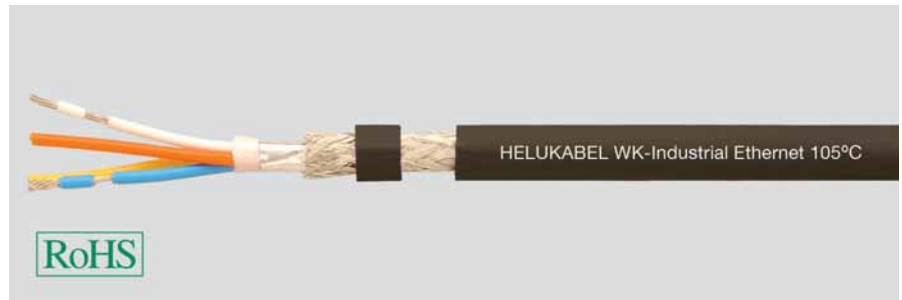
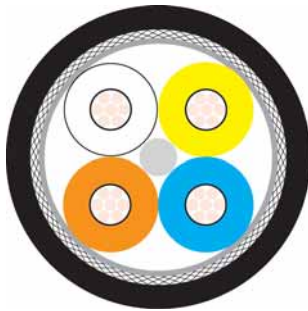

## Type

### Cable structure

Inner conductor diameter:  
Core insulation:  
Core colours:  
Stranding element:  
Separator:  
Shielding 1:  
Total shielding:  
Outer sheath material:  
Cable external diameter:  
Outer sheath colour:

## Windenergy

### SF/UTP 2x2x0,75 mm (stranded)

Copper, tinned (AWG 22/7)  
XLPE ray cross-linking  
wh, ye, bu, og  
Star quad  
Polyester foil over stranded bundle  
Al-Foil  
Cu braid, tinned  
X-FRNC  
app. 6,5 mm ± 0,2 mm  
Black similar to RAL 9005

## Electrical data

Characteristic impedance: 100 Ohm ± 15 Ohm at 1 to 100 MHz  
Conductor resistance, max.: 60 Ohm/km  
Insulation resistance, min.: 0,5 GOhm x km  
Loop resistance: 120 Ohm/km max.  
Mutual capacitance: 57 nF/km nom.  
Test voltage: 2 kV  
Relative propagation velocity: 69 %

## Typical values

Frequency (MHz)	10	16	62,5	100
Attenuation (dB/100m)	6,3	8,0	16,5	21,3
Next (dB)	70,0	65,0	55,0	50,0
ACR (dB)	63,7	57,0	38,5	28,7

## Technical data

Weight: app. 64 kg/km  
bending radius, repeated: 52 mm  
Operating temperature range min.: -40°C  
Operating temperature range max.: +105°C \*  
Caloric load, approx. value: 0,89 MJ/m  
Copper weight: 34,00 kg/km

## Norms

Acc. to ISO/IEC 11801, Acc. to EN 50173, Category 5, Flame-retardant acc. to IEC 60332-3, Halogen-free acc. to 60754-2, Corrosiveness acc. to EN50267-2-3, UL-Style 21281 80°C/300V

## Application

HELUKAT® 100IND Category 5e WK Industrial 105°C is designed specially for demanding temperature requirements such as those encountered in wind turbines. Radiation cross-linking provides improved thermal stability as well as good oil resistance.

## Part no.

**802293**, INDUSTRIAL ETHERNET CAT.5

Dimensions and specifications may be changed without prior notice.

# Industrial Ethernet

## Drag Chain ECO

**HELUKAT® 100S**

SF/UTP 4 core, Category 5e



### Type

#### Cable structure

Inner conductor diameter:  
Core insulation:  
Core colours:  
Stranding element:  
Separator:  
Shielding 1:  
Total shielding:  
Outer sheath material:  
Cable external diameter:  
Outer sheath colour:

### Drag Chain applications

#### SF/UTP 4x1x0.15 mm<sup>2</sup> (stranded)

Copper, bare (AWG 26/19)  
PO  
bl, or, whbl, whor  
Star quad  
-  
PETP fleece  
AL-Foil + braid  
PUR  
app. 4,8 mm ± 0,2 mm  
Green similar to RAL 6018

### Electrical data

Characteristic impedance: 100 Ohm ± 15 Ohm at 1 to 100 MHz  
Conductor resistance, max.: 125 Ohm/km  
Insulation resistance, min.: 5 GOhm x km  
Loop resistance: 250 Ohm/km max.  
Mutual capacitance: 50 nF/km nom.  
Test voltage: 0,5 kV  
Relative propagation velocity: 67 %

### Typical values

Frequency (MHz)	10	16	62,5	100	155
Attenuation (dB/100m)	9,5	12,1	24,8	32,0	41,0
Next (dB)	50,0	48,0	38,5	35,3	30,0

### Technical data

Weight: app. 30 kg/km  
bending radius, repeated: 70 mm  
Operating temperature range min.: -40°C  
Operating temperature range max.: +80°C  
Caloric load, approx. value: 0,37 MJ/m  
Copper weight: 17,00 kg/km

### Norms

Acc. to ISO/IEC 11801, Acc. to EN 50173, Acc. to EIA/TIA 568-A, Category 5e, Flame-retardant acc. to IEC 60332-1-2, Halogen-free acc. to 60754-2, AWM 20963 (80°C/30V)

### Application

HELUKAT® 100S Category 5e Drag Chain Eco is designed in use in cable carriers and the recurring loads cause by moving machine components. Thanks to the PU sheath, it also offers excellent resistance to common mineral oils, greases and cooling lubricants.

### Part no.

**82838**, INDUSTRIAL ETHERNET CAT.5e

Dimensions and specifications may be changed without prior notice.

# Industrial Ethernet

Drag Chain ECO

**HELUKAT® 100S**

SF/UTP 4-pair, Category 5e

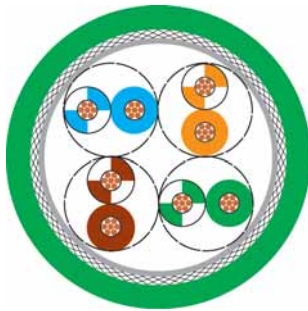

## Type

### Cable structure

Inner conductor diameter:  
Core insulation:  
Core colours:  
Stranding element:  
Separator:  
Shielding 1:  
Total shielding:  
Outer sheath material:  
Cable external diameter:  
Outer sheath colour:

## Drag Chain applications

### SF/UTP 4x2x0.15 mm<sup>2</sup> (stranded)

Copper, bare (AWG 26/19)  
PO  
whbu/bu, whog/og, whgn/gn, whbn/bn  
Double core  
-  
PETP fleece  
AL-Foil + braid  
PUR  
app. 6,6 mm ± 0,2 mm  
Green similar to RAL 6018

## Electrical data

Characteristic impedance: 100 Ohm ± 15 Ohm at 1 to 100 MHz  
Conductor resistance, max.: 125 Ohm/km  
Insulation resistance, min.: 5 GOhm x km  
Loop resistance: 250 Ohm/km max.  
Mutual capacitance: 50 nF/km nom.  
Test voltage: 0,5 kV  
Relative propagation velocity: 67 %

## Typical values

Frequency (MHz)	10	16	62,5	100	155
Attenuation (dB/100m)	9,5	12,1	24,8	32,0	41,0
Next (dB)	50,3	47,2	38,4	35,3	30,0

## Technical data

Weight: app. 56 kg/km  
bending radius, repeated: 102 mm  
Operating temperature range min.: -40°C  
Operating temperature range max.: +80°C  
Caloric load, approx. value: 0,64 MJ/m  
Copper weight: 31,00 kg/km

## Norms

Acc. to ISO/IEC 11801, Acc. to EN 50173, Acc. to EIA/TIA 568-A, Category 5e, Flame-retardant acc. to IEC 60332-1-2, Halogen-free acc. to 60754-2, AWM 20963 (80°C/30V)

## Application

HELUKAT® 100S Category 5e Drag Chain Eco is designed for use in cable carriers and the recurring loads caused by moving machine components. Thanks to the PUR sheath, it also offers excellent resistance to common mineral oils, greases and cooling lubricants.

## Part no.

**82839**, INDUSTRIAL ETHERNET CAT.5e

Dimensions and specifications may be changed without prior notice.

# Industrial Ethernet

## Drag Chain

**HELUKAT® 200S**

SF/UTP 4 core, Category 5

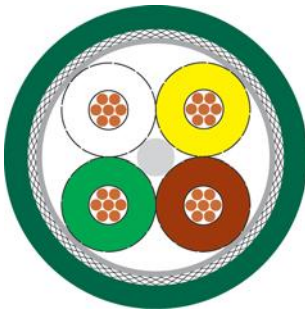

### Type

#### Cable structure

Inner conductor diameter:  
Core insulation:  
Core colours:  
Stranding element:  
Separator:  
Shielding 1:  
Screen 1 over stranding:  
Screen 2 over stranding:  
Outer sheath material:  
Cable external diameter:  
Outer sheath colour:

### Drag Chain Patch Cables

#### SF/UTP 4x1xAWG 24/19 (stranded) PUR

Copper, bare (AWG 24/19)  
PP  
wh, ye, br, gn  
Quad  
Polyester foil over stranded bundle  
-  
Al-Foil  
Cu braid  
PUR  
app. 6,2 mm ± 0,2 mm  
Green similar to RAL 6026

### Electrical data

Characteristic impedance:  
Loop resistance:  
Mutual capacitance:  
Relative propagation velocity:

100 Ohm ± 15 Ohm at 1 to 100 MHz  
156 Ohm/km max.  
51 nF/km nom.  
67 %

### Typical values

Frequency (MHz)	10	16	62,5	100
Attenuation (dB/10m)	0,6	0,8	1,6	2,2
Next (dB)	59,0	55,0	43,0	38,0
ACR (dB)	58,4	54,2	41,4	35,8

### Technical data

Weight: app. 54 kg/km  
bending radius, repeated: 75 mm  
Operating temperature range min.: -20°C  
Operating temperature range max.: +70°C  
Caloric load, approx. value: 0,944 MJ/m  
Copper weight: 30,00 kg/km

### Norms

Acc. to ISO/IEC 11801, Acc. to EN 50173, Acc. to EIA/TIA 568-A, Category 5e, Flame-retardant acc. to IEC 60332-1-2, Halogen-free acc. to 60754-2, Oil-resistant

### Application

HELUKAT® 200S Category 5e Drag Chain is designed for use in cable carriers and the extreme loads caused by moving machine components and provides excellent transmission characteristics under the most difficult and extreme conditions. Thanks to the clever structure, it is also suitable mechanically for use even in cable carriers with a high packing density.

### Part no.

**800088**, SF/UTP 4x1xAWG 24/19 PUR (S-FTP)

Dimensions and specifications may be changed without prior notice.

# Industrial Ethernet

## Drag Chain

**HELUKAT® 200S**

SF/UTP 4 pair, Category 5

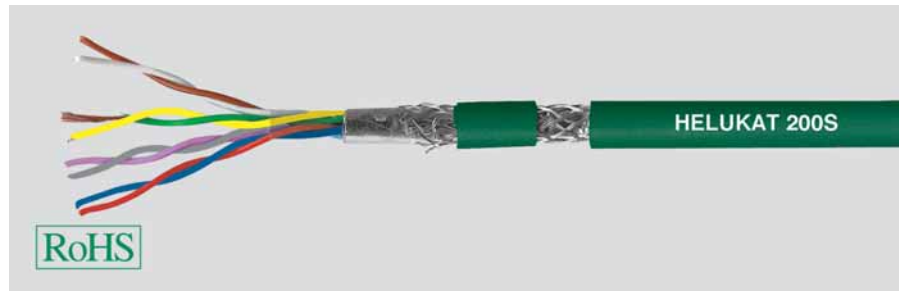

### Type

#### Cable structure

Inner conductor diameter:  
Core insulation:  
Core colours:  
Stranding element:  
Separator:  
Shielding 1:  
Screen 1 over stranding:  
Screen 2 over stranding:  
Outer sheath material:  
Cable external diameter:  
Outer sheath colour:

### Drag Chain Patch Cables

#### SF/UTP 4x2xAWG 24/19 PUR (stranded)

Copper, bare (AWG 24/19)  
PE  
wh/bn, gn/ye, gy/pk, bu/rd  
Double core  
Polyester foil over stranded bundle  
-  
Al-Foil  
Cu braid  
PUR  
app. 9,5 mm ± 0,2 mm  
Green similar to RAL 6026

### Electrical data

Characteristic impedance: 100 Ohm ± 15 Ohm at 1 to 100 MHz  
Loop resistance: 156 Ohm/km max.  
Mutual capacitance: 51 nF/km nom.  
Relative propagation velocity: 67 %

### Typical values

Frequency (MHz)	10	16	62,5	100
Attenuation (dB/10m)	0,7	0,9	1,9	2,5
Next (dB)	57,0	54,0	45,0	43,0
ACR (dB)	56,3	53,1	43,0	40,5

### Technical data

Weight: app. 110 kg/km  
bending radius, repeated: 115 mm  
Operating temperature range min.: -25°C  
Operating temperature range max.: +70°C  
Caloric load, approx. value: 2,08 MJ/m  
Copper weight: 54,30 kg/km

### Norms

Acc. to ISO/IEC 11801, Acc. to EN 50173, Acc. to EIA/TIA 568-A, Category 5, Flame-retardant acc. to IEC 60332-1-2, Halogen-free acc. to 60754-2, Oil-resistant

### Application

HELUKAT® 200S Category 5e Drag Chain is designed for use in cable carriers and the extreme loads caused by moving machine components and provides excellent transmission characteristics under the most difficult and extreme conditions. Thanks to the clever structure, it is also suitable mechanically for use even in cable carriers with a high packing density.

### Part no.

**81155**, SF/UTP 4x2xAWG 24/19 PUR (S-FTP)

Dimensions and specifications may be changed without prior notice.

# Industrial Ethernet

TORDIERFLEX

**HELUKAT® 100T**

SF/UTP, Category 5

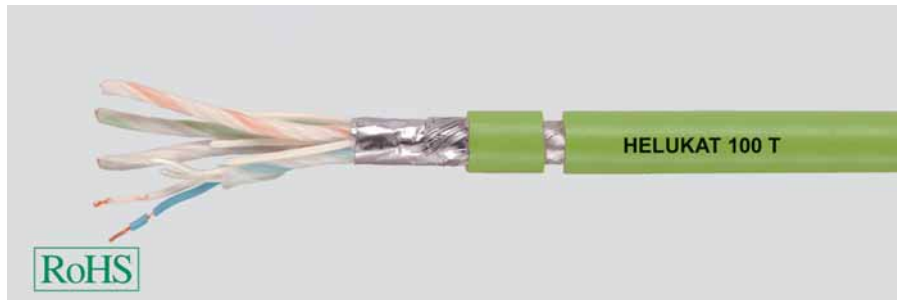

## Type

### Cable structure

Inner conductor diameter:  
Core insulation:  
Core colours:  
Stranding element:  
Separator:  
Shielding 1:  
Screen 1 over stranding:  
Screen 2 over stranding:  
Outer sheath material:  
Cable external diameter:  
Outer sheath colour:

## Torsion Patch Cables

### SF/UTP 4x2xAWG 26/19 (stranded) PUR

Copper, bare (AWG 26/19)  
PP  
wh/bu, wh/og, wh/gn, wh/bn  
Double core  
Polyester foil over stranded bundle  
-  
Polyester foil copper, bare  
Cu braid  
PUR  
app. 7,5 mm  
Green similar to RAL 6018

## Electrical data

Characteristic impedance:  
Loop resistance:  
Mutual capacitance:  
Relative propagation velocity:

100 Ohm ± 15 Ohm at 1 to 100 MHz  
260 Ohm/km max.  
50 nF/km nom.  
68 %

## Typical values

Frequency (MHz)	10	16	62,5	100
Attenuation (dB/10m)	0,9	1,2	2,4	3,1
Next (dB)	56,0	53,0	43,0	40,0
ACR (dB)	55,1	51,8	40,6	36,9

## Technical data

Weight: app. 74 kg/km  
bending radius, repeated: 56 mm  
Operating temperature range min.: -20°C  
Operating temperature range max.: +60°C  
Caloric load, approx. value: 1,234 MJ/m  
Copper weight: 29,50 kg/km

## Norms

Acc. to ISO/IEC 11801, Acc. to EN 50173, Acc. to EIA/TIA 568-A, Category 5, Flame-retardant acc. to IEC 60332-1-2, Halogen-free acc. to 60754-2, Oil-resistant, AWEM Style 20236 80°C/30V

## Application

HELUKAT® 100T Category 5 Torsionflex is designed for applications with torsion loads, e.g. in robots, and characterized by high reserve capacity and outstanding performance, even after exposure to extreme conditions. Thanks to the clever structure, it is also possible to achieve a long service life mechanically.

## Part no.

**800067**, SF/UTP 4x2xAWG 26/19 PUR (S-FTP)

Dimensions and specifications may be changed without prior notice.



# Industrial Ethernet

PROFINet Type A fixed installed + robust

**HELUKAT®**

PVC + PUR

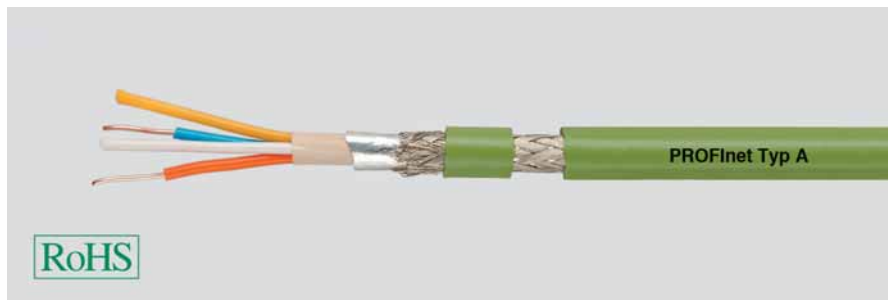

## Type Cable structure

Inner conductor diameter:  
Core insulation:  
Core colours:  
Stranding element:  
Separator:  
Inner sheath material:  
Shielding 1:  
Total shielding:  
Outer sheath material:  
Cable external diameter:  
Outer sheath colour:

## Fixed installation, indoor 2x2x0.64 mm

Copper, bare (AWG 22/1)  
PE  
wh, ye, bu, og  
Star quad  
Polyester foil over stranded bundle  
PVC  
Al-Foil  
Cu braid, tinned  
PVC  
app. 6,5 mm ± 0,2 mm  
Green similar to RAL 6018

## Industrial Area 2x2x0.64 mm

Copper, bare (AWG 22/1)  
PE  
wh, ye, bu, og  
Star quad  
Polyester foil over stranded bundle  
PVC  
Al-Foil  
Cu braid, tinned  
PUR  
app. 6,5 mm ± 0,2 mm  
Green similar to RAL 6018

## Electrical data

Characteristic impedance:  
Conductor resistance, max.:  
Insulation resistance, min.:  
Loop resistance:  
Mutual capacitance:  
Test voltage:

100 Ohm ± 15 Ohm at 1 to 100 MHz  
57,5 Ohm/km  
5 GOhm x km  
115 Ohm/km max.  
48 nF/km nom.  
2 kV

100 Ohm ± 15 Ohm at 1 to 100 MHz  
62,5 Ohm/km  
0,5 GOhm x km  
115 Ohm/km max.  
50 nF/km nom.  
2 kV

## Typical values

Frequency (MHz)	10	16	62,5	100
Attenuation (dB/100m)	5,2	6,9	15,0	19,5
Next (dB)	70,0	65,0	55,0	50,0
ACR (dB)	64,8	58,1	40,0	30,5

## Technical data

Weight:  
bending radius, repeated:  
Operating temperature range min.:  
Operating temperature range max.:  
Caloric load, approx. value:  
Copper weight:

app. 67 kg/km  
65 mm  
-40°C  
+80°C  
0,34 MJ/m  
32,00 kg/km

app. 64 kg/km  
65 mm  
-40°C  
+70°C  
0,91 MJ/m  
32,00 kg/km

## Norms

Applicable standards:

PROFINet Guideline + IEC 61158-2  
Acc. to ISO/IEC 11801  
Acc. to EN 50173  
Category 5e  
Flame-retardant acc. to IEC 60332-1-2  
CMG 75°C or PLTC or AWM 21694 600V  
CSA FT 4

PROFINet Guideline + IEC 61158-2  
Acc. to ISO/IEC 11801  
Acc. to EN 50173  
Category 5e  
Flame-retardant acc. to IEC 60332-1-2  
-  
-

## Application

HELUKAT® PROFINet Type A Category 5e for fixed installation in industrial networks, rugged. It guarantees excellent transmission characteristics and may be used even under the harshest conditions. The cable listed here corresponds to PROFINet Type A; this means the version with PVC sheath is designed for normal fixed installations and the version with PUR sheath is for difficult fixed installations in harsh industrial environments.

## Part no.

**800653**, PROFINet type A (SK)

**801194**, PROFINet type A (SK)

Dimensions and specifications may be changed without prior notice.

# Industrial Ethernet

PROFInet Type A fixed installed FRNC

HELUKAT®

FRNC

NEW

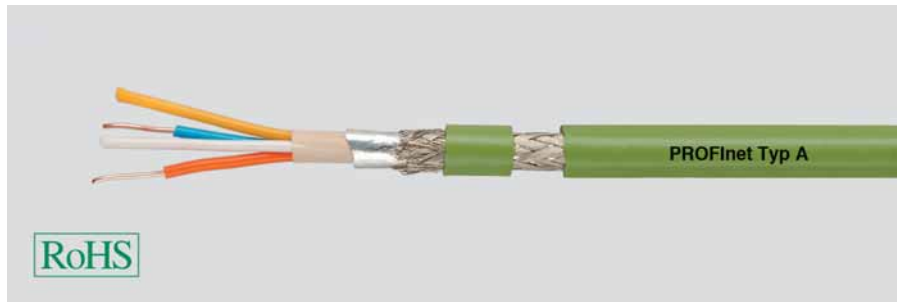
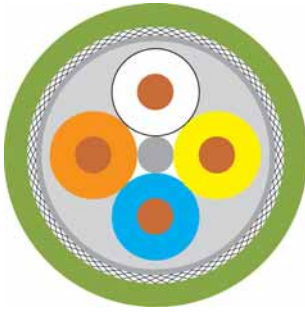

## Type

### Cable structure

Inner conductor diameter:  
Core insulation:  
Core colours:  
Stranding element:  
Separator:  
Inner sheath material:  
Shielding 1:  
Total shielding:  
Outer sheath material:  
Cable external diameter:  
Outer sheath colour:

## Fixed installation, indoor

### 2x2x0.64 mm

Copper, bare (AWG 22/1)  
PE  
wh, ye, bu, og  
Star quad  
Polyester foil over stranded bundle  
FRNC  
Al-Foil  
Cu braid, tinned  
FRNC  
app. 6,5 mm ± 0,2 mm  
Green similar to RAL 6018

## Electrical data

Characteristic impedance: 100 Ohm ± 15 Ohm at 1 to 100 MHz  
Conductor resistance, max.: 57,5 Ohm/km  
Insulation resistance, min.: 5 GOhm x km  
Loop resistance: 115 Ohm/km max.  
Mutual capacitance: 48 nF/km nom.  
Test voltage: 2 kV

## Typical values

Frequency (MHz)	10	16	62,5	100
Attenuation (dB/100m)	5,2	6,9	15,0	19,5
Next (dB)	70,0	65,0	55,0	50,0
ACR (dB)	64,8	58,1	40,0	30,5

## Technical data

Weight: app. 65 kg/km  
bending radius, repeated: 65 mm  
Operating temperature range min.: -25°C  
Operating temperature range max.: +75°C  
Caloric load, approx. value: 0,34 MJ/m  
Copper weight: 32,00 kg/km

## Norms

Applicable standards: PROFInet Guideline + IEC 61158-2  
Acc. to ISO/IEC 11801  
Acc. to EN 50173  
Category 5e  
Halogen-free acc. to 60754-2  
Flame-retardant acc. to IEC 60332-1-2  
Corrosiveness acc. to EN50267-2-3  
Low-smoke acc. to EN50268-2  
UL Style: CMG 75°C PLTC FT4  
CSA standard: CSA FT 4

## Application

HELUKAT® PROFInet Type A FRNC Category 5e for fixed installation in industrial networks, rugged. It guarantees excellent transmission characteristics and may be used even under the harshest conditions. The cable listed here corresponds to PROFInet Type A in halogen free and flame retardant design.

## Part no.

**805653**, PROFInet type A (SK)

Dimensions and specifications may be changed without prior notice.

# Industrial Ethernet

PROFINet Type A radiation resistant + armoured

**HELUKAT®**

PUR + PE

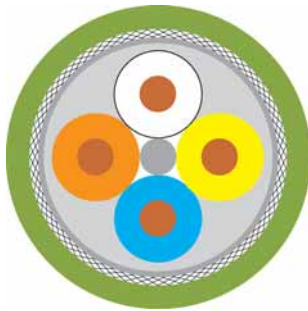

## Type Cable structure

Inner conductor diameter:  
Core insulation:  
Core colours:  
Stranding element:  
Separator:  
Inner sheath material:  
Shielding 1:  
Total shielding:  
Armouring:  
Outer sheath material:  
Cable external diameter:  
Outer sheath colour:

## ray loaded areas 2x2x0.64 mm

Copper, bare (AWG 22/1)  
XLPE ray cross-linking  
wh, ye, bu, og  
Star quad  
Polyester foil over stranded bundle  
TPR ray cross-linking  
Al-Foil  
Cu braid, tinned  
-  
PUR  
app. 6,5 mm ± 0,2 mm  
Green similar to RAL 6018

## Fixed installation, outdoor 2x2x0.64 mm

Copper, bare (AWG 22/1)  
PE  
wh, ye, bu, og  
Star quad  
Polyester foil over stranded bundle  
PVC  
Al-Foil  
Cu braid, tinned  
Steel band  
PE  
app. 9,3 mm ± 0,5 mm  
Black

## Electrical data

Characteristic impedance:  
Conductor resistance, max.:  
Insulation resistance, min.:  
Loop resistance:  
Mutual capacitance:  
Test voltage:

100 Ohm ± 15 Ohm at 1 to 100 MHz  
62 Ohm/km  
0,5 GOhm x km  
124 Ohm/km max.  
50 nF/km nom.  
2 kV

100 Ohm ± 15 Ohm at 1 to 100 MHz  
57,5 Ohm/km  
0,5 GOhm x km  
115 Ohm/km max.  
50 nF/km nom.  
2 kV

## Typical values

Frequency (MHz)	10	16	62,5	100
Attenuation (dB/100m)	5,2	6,9	15,0	19,5
Next (dB)	70,0	65,0	55,0	50,0
ACR (dB)	64,8	58,1	40,0	30,5

## Technical data

Weight: app. 63 kg/km  
bending radius, repeated: 100 mm  
Operating temperature range min.: -40°C  
Operating temperature range max.: +80°C  
Caloric load, approx. value: 0,29 MJ/m  
Copper weight: 32,00 kg/km

app. 124 kg/km  
100 mm  
-40°C  
+70°C  
2,14 MJ/m  
31,00 kg/km

## Norms

Applicable standards: PROFINet Guideline + IEC 61158-2  
Acc. to ISO/IEC 11801  
Acc. to EN 50173  
Category 5e

PROFINet Guideline + IEC 61158-2  
Acc. to ISO/IEC 11801  
Acc. to EN 50173  
Category 5e

## Application

HELUKAT® PROFINet Type A Cat 5e is radiation-resistant + armoured for fixed installation in industrial networks. It guarantees excellent transmission characteristics and may be used even under the harshest conditions. The cables listed here correspond to PROFINet Type A and thanks to their special construction with cross-linked PVC-inner sheath/PUR outer sheath are well-suited for fixed applications inside irradiated areas, while the armoured type with PVC inner sheath/PE outer sheath is ideal for areas with rodent problems.

## Part no.

**801195**, PROFINet type A (SK)

**801650**, PROFINet type A (SK)

Dimensions and specifications may be changed without prior notice.

# Industrial Ethernet

## PROFINet Type B flexible

**HELUKAT**<sup>®</sup>

PVC



### Type

#### Cable structure

Inner conductor diameter:  
Core insulation:  
Core colours:  
Stranding element:  
Separator:  
Inner sheath material:  
Shielding 1:  
Total shielding:  
Outer sheath material:  
Cable external diameter:  
Outer sheath colour:

### Mobile use

#### 2x2x0,75 mm (stranded)

Copper, tinned (AWG 22/7)  
PE  
wh, ye, bu, og  
Star quad  
Polyester foil over stranded bundle  
PVC  
Al-Foil  
Cu braid, tinned  
PVC  
app. 6,5 mm ± 0,2 mm  
Green similar to RAL 6018

### Electrical data

Characteristic impedance: 100 Ohm ± 15 Ohm at 1 to 100 MHz  
Conductor resistance, max.: 60 Ohm/km  
Insulation resistance, min.: 0,5 GOhm x km  
Loop resistance: 120 Ohm/km max.  
Mutual capacitance: 52 nF/km nom.  
Test voltage: 2 kV

### Typical values

Frequency (MHz)	10	16	62,5	100
Attenuation (dB/100m)	6,3	8,0	16,5	21,3
Next (dB)	70,0	65,0	55,0	50,0
ACR (dB)	64,0	57,4	39,0	29,0

### Technical data

Weight: app. 67 kg/km  
bending radius, repeated: 100 mm  
Operating temperature range min.: -40°C  
Operating temperature range max.: +70°C  
Caloric load, approx. value: 0,32 MJ/m  
Copper weight: 32,00 kg/km

### Norms

Applicable standards: PROFINet Guideline + IEC 61158-2  
Acc. to ISO/IEC 11801  
Acc. to EN 50173  
Category 5e  
Flame-retardant acc. to IEC 60332-3  
UL Style: CMG 75°C PLTC FT4  
CSA standard: CSA FT 4

### Application

HELUKAT<sup>®</sup> PROFINet Type B (flexible) Cat.5e for use on moving parts. The cables listed here correspond to the PROFINet classifications Type B for moving cables and are designed to withstand mechanical loads. The version PVC is the standard cable; the FRNC version is used for halogen free requirements.

### Part no.

**800654**, PROFINet type B (SK)

Dimensions and specifications may be changed without prior notice.

# Industrial Ethernet

## PROFINet Type B flexible

**HELUKAT**<sup>®</sup>

FRNC

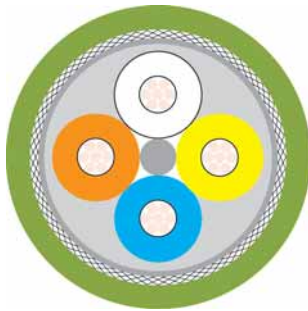

NEW

### Type

#### Cable structure

Inner conductor diameter:  
Core insulation:  
Core colours:  
Stranding element:  
Separator:  
Inner sheath material:  
Shielding 1:  
Total shielding:  
Outer sheath material:  
Cable external diameter:  
Outer sheath colour:

### Mobile use

#### 2x2x0,75 mm (stranded)

Copper, tinned (AWG 22/7)  
PE  
wh, ye, bu, og  
Star quad  
Polyester foil over stranded bundle  
FRNC  
Al-Foil  
Cu braid, tinned  
FRNC  
app. 6,5 mm ± 0,2 mm  
Green similar to RAL 6018

### Electrical data

Characteristic impedance: 100 Ohm ± 15 Ohm at 1 to 100 MHz  
Conductor resistance, max.: 60 Ohm/km  
Insulation resistance, min.: 0,5 GOhm x km  
Loop resistance: 120 Ohm/km max.  
Mutual capacitance: 52 nF/km nom.  
Test voltage: 2 kV

### Typical values

Frequency (MHz)	10	16	62,5	100
Attenuation (dB/100m)	6,3	8,0	16,5	21,3
Next (dB)	70,0	65,0	55,0	50,0
ACR (dB)	64,0	57,4	39,0	29,0

### Technical data

Weight: app. 65 kg/km  
bending radius, repeated: 100 mm  
Operating temperature range min.: -25°C  
Operating temperature range max.: +75°C  
Caloric load, approx. value: 0,32 MJ/m  
Copper weight: 32,00 kg/km

### Norms

Applicable standards: PROFINet Guideline + IEC 61158-2  
Acc. to ISO/IEC 11801  
Acc. to EN 50173  
Category 5e  
Halogen-free acc. to 60754-2  
Flame-retardant acc. to IEC 60332-3  
Corrosiveness acc. to EN50267-2-3  
Low-smoke acc. to EN50268-2  
CMG 75°C PLTC FT4  
CSA FT 4

UL Style:  
CSA standard:

### Application

HELUKAT<sup>®</sup> PROFINet Type B (flexible) Category 5e for flexible use. The cable listed here correspond to the PROFINet classification Type B.

### Part no.

**805654**, PROFINet type B (SK)

Dimensions and specifications may be changed without prior notice.

# Industrial Ethernet

PROFINet Type B flexible hybrid

HELUKAT®

FRNC

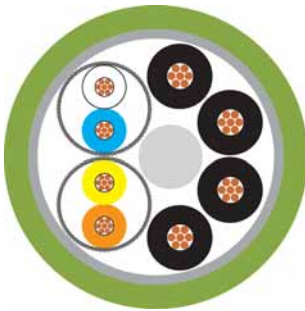

## Type

### Cable structure

Inner conductor diameter 1:  
Inner conductor diameter 2:  
Core insulation 1:  
Core insulation 2:  
Core colours 1:  
Core colours 2:  
Stranding element 1:  
Separator:  
Shielding 1:  
Total shielding:  
Outer sheath material:  
Cable external diameter:  
Outer sheath colour:

## Mobile use

### 2x2x0,75 mm (stranded)+ 4x1,5qmm

Copper, bare (AWG 22/7)  
Copper, bare (AWG 16/84)  
Foam-skin-PE  
PO  
wh, ye, bu, og  
Black  
Double core  
Polyester foil over stranded bundle  
AL-Foil + braid  
Polyester foil  
FRNC  
app. 10,3 mm ± 0,3 mm  
Green similar to RAL 6018

## Electrical data

Characteristic impedance: 100 Ohm ± 15 Ohm at 1 to 100 MHz  
Conductor resistance, max.: 60 Ohm/km  
Insulation resistance, min.: 0,5 GOhm x km  
Loop resistance: 120 Ohm/km max.  
Mutual capacitance: 52 nF/km nom.  
Test voltage: 2 kV

## Typical values

Frequency (MHz)	10	16	62,5	100
Attenuation (dB/100m)	6,3	8,0	16,5	21,3
Next (dB)	50,3	47,2	38,4	35,3
ACR (dB)	43,7	39,0	21,5	13,7

## Technical data

Weight: app. 153 kg/km  
bending radius, repeated: 103 mm  
Operating temperature range min.: -40°C  
Operating temperature range max.: +70°C  
Caloric load, approx. value: 1,50 MJ/m  
Copper weight: 94,00 kg/km

## Norms

Applicable standards: PROFINet Guideline + IEC 61158-2  
Acc. to ISO/IEC 11801  
Acc. to EN 50173  
Category 5e  
Halogen-free acc. to 60754-2  
Flame-retardant acc. to IEC 60332-1-2  
Corrosiveness acc. to EN50267-2-3  
Low-smoke acc. to EN50268-2  
UL Style: UL Style 21282

## Application

HELUKAT® PROFINet Type B Category 5e hybrid for flexible applications. The cable listed here corresponds to PROFINet Type B with integrated power supply in a cable with halogen-free and flame-retardent construction.

## Part no.

**801651**, PROFINet type B (SK)

Dimensions and specifications may be changed without prior notice.

# Industrial Ethernet

PROFINet Typ B SHIPLINE \* FESTOON

**HELUKAT**<sup>®</sup>

FRNC + PVC

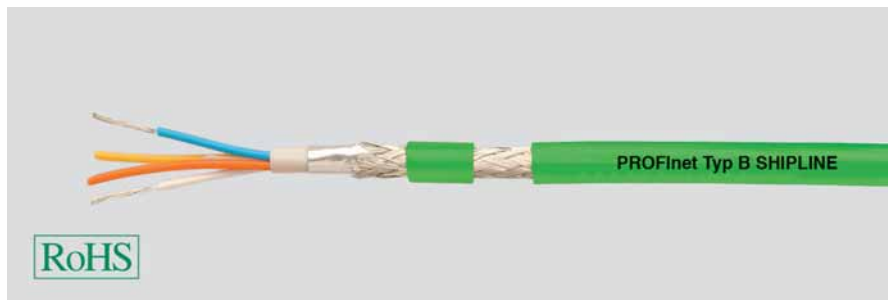
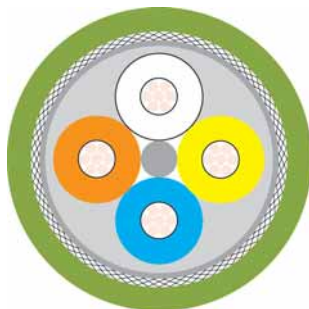

## Type Cable structure

Inner conductor diameter:  
Core insulation:  
Core colours:  
Stranding element:  
Separator:  
Inner sheath material:  
Shielding 1:  
Total shielding:  
Outer sheath material:  
Cable external diameter:  
Outer sheath colour:

## Marine and Offshore 2x2x0,75 mm (stranded)

Copper, tinned (AWG 22/7)  
PP  
wh, ye, bu, og  
Star quad  
Polyester foil over stranded bundle  
FRNC  
Al-Foil  
Cu braid, tinned  
FRNC  
app. 6,5 mm ± 0,4 mm  
Green similar to RAL 6018

## FESTOON 2x2x0.75 mm (stranded)

Copper, tinned (AWG 22/7)  
PE  
wh, ye, bu, og  
Star quad  
Polyester foil over stranded bundle  
PVC  
Al-Foil  
Cu braid, tinned  
PVC  
app. 6,5 mm ± 0,2 mm  
Green similar to RAL 6018

## Electrical data

Characteristic impedance:  
Conductor resistance, max.:  
Insulation resistance, min.:  
Loop resistance:  
Mutual capacitance:  
Test voltage:

100 Ohm ± 15 Ohm at 1 to 100 MHz  
60 Ohm/km  
0,5 GOhm x km  
120 Ohm/km max.  
52 nF/km nom.  
0,7 kV

100 Ohm ± 15 %  
60 Ohm/km  
0,5 GOhm x km  
120 Ohm/km max.  
52 nF/km nom.  
2 kV

## Typical values

Frequency (MHz)	10	16	62,5	100
Attenuation (dB/100m)	6,0	7,6	16,0	21,0
Next (dB)	70,0	65,0	55,0	50,0
ACR (dB)	64,0	57,4	39,0	29,0

## Technical data

Weight:  
bending radius, repeated:  
Operating temperature range min.:  
Operating temperature range max.:  
Caloric load, approx. value:  
Copper weight:

app. 64 kg/km  
50 mm  
-40°C  
+75°C  
0,45 MJ/m  
32,00 kg/km

app. 68 kg/km  
70 mm  
-10°C  
+80°C  
1,20 MJ/m  
32,00 kg/km

## Norms

Applicable standards:

PROFINet Guideline + IEC 61158-2  
Acc. to ISO/IEC 11801  
Acc. to EN 50173  
Category 5e  
Halogen-free acc. to 60754-2  
Flame-retardant acc. to IEC 60332-3  
Corrosiveness acc. to EN50267-2-3  
Low-smoke acc. to EN50268-2  
CMG 75°C PLTC FT4  
CSA FT 4

PROFINet Guideline + IEC 61158-2  
Acc. to ISO/IEC 11801  
Acc. to EN 50173  
Category 5e  
Flame-retardant acc. to IEC 60332-3

UL Style:

CSA standard:

CMG 75°C or PLTC or AWM 21694 600V  
CSA FT 4

## Application

HELUKAT<sup>®</sup> PROFINet Type B Category 5e SHIPLINE + FESTOON designed specially for marine/offshore applications as well as FESTOON applications. The SHIPLINE version is certified by the **Germanische Lloyd** and suitable for flexible **marine and offshore applications**.

## Part no.

**802185**, PROFINet type B (SK)

**803295**, PROFINet type B (SK)

Dimensions and specifications may be changed without prior notice.

# Industrial Ethernet

PROFINet Type C high flexible

**HELUKAT**<sup>®</sup>

PVC + PUR

NEW



## Type Cable structure

Inner conductor diameter:  
Core insulation:  
Core colours:  
Stranding element:  
Separator:  
Inner sheath material:  
Shielding 1:  
Total shielding:  
Outer sheath material:  
Cable external diameter:  
Outer sheath colour:

## Drag Chain applications 2x2x0.75 mm (stranded)

Copper, tinned (AWG 22/7)  
PE  
wh, ye, bu, og  
Star quad  
Polyester foil over stranded bundle  
PVC  
Al-Foil  
Cu braid, tinned  
PVC  
app. 6,5 mm ± 0,2 mm  
Green similar to RAL 6018

## Drag Chain applications 2x2x0.75 mm (stranded)

Copper, tinned (AWG 22/7)  
PE  
wh, ye, bu, og  
Star quad  
Polyester foil over stranded bundle  
FRNC  
Al-Foil  
Cu braid, tinned  
PUR  
app. 6,5 mm ± 0,2 mm  
Green similar to RAL 6018

## Electrical data

Characteristic impedance: 100 Ohm ± 15 Ohm at 1 to 100 MHz  
Conductor resistance, max.: 60 Ohm/km  
Insulation resistance, min.: 0,5 GOhm x km  
Loop resistance: 120 Ohm/km max.  
Mutual capacitance: 52 nF/km nom.  
Test voltage: 1,5 kV

100 Ohm ± 15 Ohm at 1 to 100 MHz  
60 Ohm/km  
0,5 GOhm x km  
120 Ohm/km max.  
52 nF/km nom.  
1,5 kV

## Typical values

		10	16	62,5	100
Frequency (MHz)					
Attenuation (dB/100m)		6,3	8,0	16,5	21,3
Next (dB)		70,0	65,0	55,0	50,0
ACR (dB)		64,0	57,4	39,0	29,0

## Technical data

Weight: app. 68 kg/km  
bending radius, repeated: 55 mm  
Operating temperature range min.: -20°C  
Operating temperature range max.: +70°C  
Caloric load, approx. value: 0,85 MJ/m  
Copper weight: 32,00 kg/km

app. 61 kg/km  
55 mm  
-20°C  
+60°C  
0,85 MJ/m  
32,00 kg/km

## Norms

Applicable standards: PROFINet Guideline + IEC 61158-2  
Acc. to ISO/IEC 11801  
Acc. to EN 50173  
Category 5e  
Flame-retardant CSA FT4

UL Style: CMG FT4

PROFINet Guideline + IEC 61158-2  
Acc. to ISO/IEC 11801  
Acc. to EN 50173  
Category 5e  
Halogen-free acc. to 60754-2  
Flame-retardant acc. to IEC 60332-1-2  
CMX 75°C (shielded)

## Application

HELUKAT<sup>®</sup> PROFINet Type C PVC (highly flexible) Category 5e for use on moving parts and in cable carriers. The cable listed here correspond to the PROFINet classifications Type C for moving cables and are designed to withstand mechanical loads. Thanks to the flame retardant jacket the PVC cable has UL CMG PLTC FT4 approval. The PUR version has UL CMX listing and offers higher values in chain and chemical resistance.

## Part no.

**802914**, PROFINet type C (SK)

**800655**, PROFINet type C (SK)

Dimensions and specifications may be changed without prior notice.



# Industrial Ethernet

## PROFINet Type C Torsion

**HELUKAT**<sup>®</sup>

PUR



### Type

#### Cable structure

Inner conductor diameter:  
Core insulation:  
Core colours:  
Stranding element:  
Separator:  
Shielding 1:  
Total shielding:  
Outer sheath material:  
Cable external diameter:  
Outer sheath colour:

### Torsional applications

#### 2x2x0,75 mm (stranded)

Copper, tinned (AWG 22/19)  
Foam-skin-PE  
wh, ye, bu, og  
Star quad  
Polyester foil over stranded bundle  
Cu braid, tinned  
Cu braid, tinned  
PUR  
app. 6,5 mm ± 0,2 mm  
Green similar to RAL 6018

### Electrical data

Characteristic impedance: 100 Ohm ± 15 Ohm at 1 to 100 MHz  
Conductor resistance, max.: 60 Ohm/km  
Insulation resistance, min.: 0,5 GOhm x km  
Loop resistance: 120 Ohm/km max.  
Mutual capacitance: 52 nF/km nom.  
Test voltage: 0,7 kV

### Typical values

Frequency (MHz)	10	16	62,5	100
Attenuation (dB/100m)	7,6	10,0	26,5	41,0
ELFEXT (dB)	43,8	39,7	24,0	20,0

### Technical data

Weight: app. 54 kg/km  
bending radius, repeated: 70 mm  
Operating temperature range min.: -40°C  
Operating temperature range max.: +80°C  
Caloric load, approx. value: 0,45 MJ/m  
Copper weight: 32,00 kg/km

### Norms

Applicable standards: PROFINet Guideline + IEC 61158-2  
Category 5e  
Halogen-free acc. to 60754-2  
Flame-retardant acc. to IEC 60332-1-2  
UL Style: AWM Style 21161 80°C

### Application

HELUKAT<sup>®</sup> PROFINet Type C Category 5e TORSION offers excellent transmission characteristics and is designed for applications with torsion loads, e.g. in robots. The cable listed here corresponds to the PROFINet Type C classification for continuous movement.

### Part no.

**802186**, PROFINet type C (SK)

Dimensions and specifications may be changed without prior notice.

# BUS Cables

Profibus L2 indoor

**HELUKABEL®**

PVC

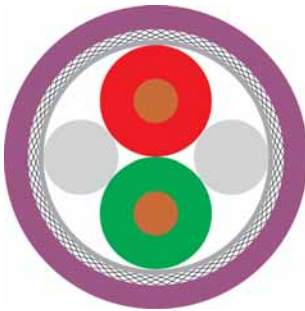

## Type

### Cable structure

Inner conductor diameter:  
Core insulation:  
Core colours:  
Stranding element:  
Separator:  
Shielding 1:  
Total shielding:  
Outer sheath material:  
Cable external diameter:  
Outer sheath colour:

### Fixed installation, indoor 1x2x0.64 mm

Copper, bare (AWG 22/1)  
Foam-skin-PE  
rd, gn  
2 cores + 2 fillers stranded together  
Polyester foil over stranded bundle  
Al-Foil  
Cu braid, tinned  
PVC  
app. 7,8 mm ± 0,2 mm  
Grey similar to RAL 7001

### Fixed installation, indoor 1x2x0.64 mm

Copper, bare (AWG 22/1)  
Foam-skin-PE  
rd, gn  
2 cores + 2 fillers stranded together  
Polyester foil over stranded bundle  
Al-Foil  
Cu braid, tinned  
PVC  
app. 7,8 mm ± 0,2 mm  
Violet similar to RAL 4001

## Electrical data

Characteristic impedance:  
Conductor resistance, max.:  
Insulation resistance, min.:  
Loop resistance:  
Mutual capacitance:  
Test voltage:  
Attenuation:

150 Ohm ± 10 %  
55 Ohm/km  
1 GOhm x km  
110 Ohm/km max.  
30 nF/km nom.  
1,5 kV  
9,6 kHz < 2,5 dB/km  
38,4 kHz < 4,0 dB/km  
4 MHz < 22,0 dB/km  
16 MHz < 42,0 dB/km

150 Ohm ± 10 %  
55 Ohm/km  
1 GOhm x km  
110 Ohm/km max.  
30 nF/km nom.  
1,5 kV  
9,6 kHz < 2,5 dB/km  
38,4 kHz < 4,0 dB/km  
4 MHz < 22,0 dB/km  
16 MHz < 42,0 dB/km

## Technical data

Weight:  
bending radius, repeated:  
Operating temperature range min.:  
Operating temperature range max.:  
Caloric load, approx. value:  
Copper weight:

app. 69 kg/km  
120 mm  
-40°C  
+70°C  
0,99 MJ/m  
24,00 kg/km

app. 69 kg/km  
120 mm  
-40°C  
+70°C  
0,99 MJ/m  
24,00 kg/km

## Norms

Applicable standards:

UL Style:  
CSA standard:

Profibus acc. to DIN 19245 T3 and EN50170  
Flame-retardant acc. to IEC 60332-1-2  
CMX 75°C (shielded)  
CSA FT1

Profibus acc. to DIN 19245 T3 and EN50170  
Flame-retardant acc. to IEC 60332-1-2  
CMX 75°C (shielded)  
CSA FT1

## Application

HELUKABEL® Profibus L2 Indoor is designed for fixed indoor installation in Profibus industrial networks. Depending on the application, the colour grey (special colour) or violet (standard colour) is available. Otherwise, the technical characteristics of the two products are identical.

## Part no.

**80384**, Profibus L2

**81448**, Profibus L2

Dimensions and specifications may be changed without prior notice.

# BUS Cables

PROFIBUS L2 Outdoor + Industry

**HELUKABEL®**

PE + PUR

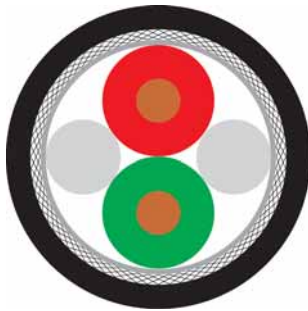

## Type

### Cable structure

Inner conductor diameter:  
Core insulation:  
Core colours:  
Stranding element:  
Separator:  
Shielding 1:  
Total shielding:  
Outer sheath material:  
Cable external diameter:  
Outer sheath colour:

## Fixed installation, outdoor

### 1x2x0.64 mm

Copper, bare (AWG 22/1)  
Foam-skin-PE  
rd, gn  
2 cores + 2 fillers stranded together  
Polyester foil over stranded bundle  
Al-Foil  
Cu braid, tinned  
PE  
app. 8,0 mm ± 0,4 mm  
Black similar to RAL 9005

## Industrial Area

### 1x2x0.64 mm

Copper, bare (AWG 22/1)  
Foam-skin-PE  
rd, gn  
2 cores + 2 fillers stranded together  
Polyester foil over stranded bundle  
Al-Foil  
Cu braid, tinned  
PUR  
app. 8,0 mm ± 0,4 mm  
Petrol similar to RAL 5018

## Electrical data

Characteristic impedance:  
Conductor resistance, max.:  
Insulation resistance, min.:  
Loop resistance:  
Mutual capacitance:  
Test voltage:  
Attenuation:

150 Ohm ± 10 %  
55 Ohm/km  
1 GOhm x km  
110 Ohm/km max.  
30 nF/km nom.  
1,5 kV  
9,6 kHz < 2,5 dB/km  
38,4 kHz < 4,0 dB/km  
4 MHz < 22,0 dB/km  
16 MHz < 42,0 dB/km

150 Ohm ± 10 %  
55 Ohm/km  
1 GOhm x km  
110 Ohm/km max.  
30 nF/km nom.  
1,5 kV  
9,6 kHz < 2,5 dB/km  
38,4 kHz < 4,0 dB/km  
4 MHz < 22,0 dB/km  
16 MHz < 42,0 dB/km

## Technical data

Weight:  
bending radius, repeated:  
Operating temperature range min.:  
Operating temperature range max.:  
Caloric load, approx. value:  
Copper weight:

app. 64 kg/km  
120 mm  
-40°C  
+70°C  
2,26 MJ/m  
24,00 kg/km

app. 67 kg/km  
120 mm  
-40°C  
+70°C  
1,52 MJ/m  
24,00 kg/km

## Norms

Applicable standards:

Profibus acc. to DIN 19245 T3 and EN50170  
Halogen-free acc. to 60754-2

Profibus acc. to DIN 19245 T3 and EN50170  
Halogen-free acc. to 60754-2  
Flame-retardant acc. to IEC 60332-1-2

## Application

HELUKABEL® Profibus L2 Outdoor + Industry are special cables for use in Profibus industrial networks. The Outdoor version is designed for use in open-air environments, i.e. can withstand wind, weather and sun (not for burial directly in the ground). The Industry version is used in fixed installation applications in harsh industrial environment. Mechanically, this product exhibits excellent resistance to mineral oils, greases and cooling lubricants and has good microbe and hydrolysis resistance.

## Part no.

**80792**, Profibus L2

**81186**, Profibus L2

Dimensions and specifications may be changed without prior notice.

# BUS Cables

## Profibus L2 direct Burial without + with Armouring



PE

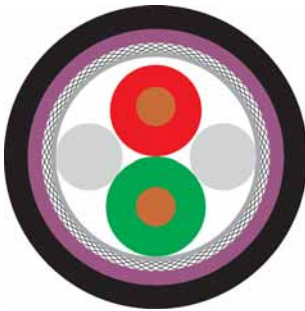

### Type Cable structure

Inner conductor diameter:  
Core insulation:  
Core colours:  
Stranding element:  
Separator:  
Inner sheath material:  
Shielding 1:  
Total shielding:  
Armouring:  
Outer sheath material:  
Cable external diameter:  
Outer sheath colour:

### Direct burial 1x2x0.64 mm

Copper, bare (AWG 22/1)  
Foam-skin-PE  
rd, gn  
2 cores + 2 fillers stranded together  
Polyester foil over stranded bundle  
PVC  
Al-Foil  
Cu braid, tinned  
-  
PE  
app. 10,0 mm ± 0,2 mm  
Black similar to RAL 9005

### Direct burial 1x2x0.64 mm

Copper, bare (AWG 22/1)  
Cell PE  
rd, gn  
2 cores + 2 fillers stranded together  
-  
PVC  
Al-Foil  
Cu braid, tinned  
Steel band  
PE  
app. 10,6 mm ± 0,5 mm  
Black similar to RAL 9005

### Electrical data

Characteristic impedance:  
Conductor resistance, max.:  
Insulation resistance, min.:  
Loop resistance:  
Mutual capacitance:  
Nominal voltage:  
Test voltage:  
Attenuation:

150 Ohm ± 10 %  
55 Ohm/km  
1 GOhm x km  
110 Ohm/km max.  
30 nF/km nom.  
-  
1,5 kV  
9,6 kHz < 2,5 dB/km  
38,4 kHz < 4,0 dB/km  
3 MHz < 22,0 dB/km  
20 MHz < 42,0 dB/km

150 Ohm ± 10 %  
55 Ohm/km  
5 GOhm x km  
110 Ohm/km max.  
30 nF/km nom.  
250 V  
1,5 kV  
9,6 kHz < 2,5 dB/km  
38,4 kHz < 4,0 dB/km  
4 MHz < 22,0 dB/km  
16 MHz < 42,0 dB/km

### Technical data

Weight:  
bending radius, repeated:  
Operating temperature range min.:  
Operating temperature range max.:  
Caloric load, approx. value:  
Copper weight:

app. 92 kg/km  
150 mm  
-40°C  
+80°C  
2,657 MJ/m  
24,00 kg/km

app. 132 kg/km  
165 mm  
-40°C  
+80°C  
2,40 MJ/m  
24,00 kg/km

### Norms

Applicable standards:

Profibus acc. to DIN 19245 T3 and EN50170

Profibus acc. to DIN 19245 T3 and EN50170

### Application

HELUKABEL® Profibus L2 Direct Burial cables without + with armouring are special cables in the Profibus industrial networks. The version without armouring is for normal and direct cable burial in the ground. The version with steel tape armouring offers additional protection against rodents and is the right choice for regions with such animals.

### Part no.

**82824**, Profibus ERD

**802177**, Profibus L2

Dimensions and specifications may be changed without prior notice.

# BUS Cables

## Profibus L2 7-wire



PVC

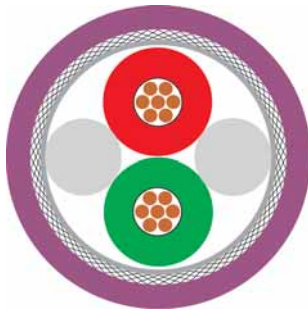

### Type

#### Cable structure

Inner conductor diameter:  
Core insulation:  
Core colours:  
Stranding element:  
Separator:  
Shielding 1:  
Total shielding:  
Outer sheath material:  
Cable external diameter:  
Outer sheath colour:

### Mobile use

#### 1x2x0.64 mm (stranded)

Copper, bare (AWG 24/7)  
Foam-skin-PE  
rd, gn  
2 cores + 2 fillers stranded together  
Polyester foil over stranded bundle  
Al-Foil  
Cu braid, tinned  
PVC  
app. 7,8 mm ± 0,3 mm  
Violet similar to RAL 4001

### Electrical data

Characteristic impedance: 150 Ohm ± 10 %  
Conductor resistance, max.: 80 Ohm/km  
Insulation resistance, min.: 2 GOhm x km  
Loop resistance: 160 Ohm/km max.  
Mutual capacitance: 30 nF/km nom.  
Test voltage: 1,5 kV  
Attenuation: 9,6 kHz < 2,9 dB/km  
38,4 kHz < 4,6 dB/km  
4 MHz < 25,0 dB/km  
16 MHz < 49,0 dB/km

### Technical data

Weight: app. 70 kg/km  
bending radius, repeated: 94 mm  
Operating temperature range min.: -30°C  
Operating temperature range max.: +80°C  
Caloric load, approx. value: 1,20 MJ/m  
Copper weight: 24,00 kg/km

### Norms

Applicable standards: Profibus acc. to DIN 19245 T3 and EN50170  
Flame-retardant acc. to EN 50265-2-1  
UL Style: UL Style 2571

### Application

HELUKABEL® Profibus L2 7-wire for mobile applications in Profibus industrial networks. With its core design and the special PVC sheath, the type described here is suitable for normal mobile applications.

### Part no.

**800648**, Profibus L2

Dimensions and specifications may be changed without prior notice.

# BUS Cables

Profibus fixed installed High Temperature +105°C or + 200°C

**HELUKABEL®**

PVC + FRNC PH120

NEW

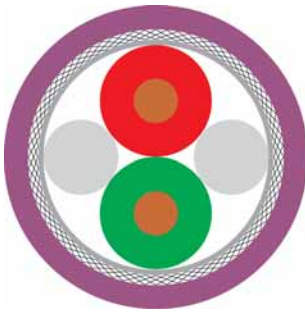

## Type

### Cable structure

Inner conductor diameter:  
Core insulation:  
Core colours:  
Stranding element:  
Separator:  
Shielding 1:  
Total shielding:  
Outer sheath material:  
Cable external diameter:  
Outer sheath colour:

## Fixed installation, indoor

### 1x2x0.64 mm

Copper, bare (AWG 22/1)  
Foam-skin-PE  
rd, gn  
2 cores + 2 fillers stranded together  
Polyester foil over stranded bundle  
Al-Foil  
Cu braid, tinned  
PVC  
app. 7,8 mm ± 0,2 mm  
Violet similar to RAL 4001

## High temperature areas

### 1x2xAWG23/1

Copper, bare (AWG 23/1)  
Rubber compound  
rd, gn  
2 cores + 2 fillers stranded together  
-  
-  
AL-Foil + braid  
FRNC  
app. 8,3 mm ± 0,3 mm  
Black similar to RAL 9005

## Electrical data

Characteristic impedance:  
Conductor resistance, max.:  
Insulation resistance, min.:  
Loop resistance:  
Mutual capacitance:  
Test voltage:  
Attenuation:

150 Ohm ± 10 %  
55 Ohm/km  
1 GOhm x km  
110 Ohm/km max.  
30 nF/km nom.  
1,5 kV  
Frequency at +20°C  
9,6 kHz < 3,0 dB/km  
38,4 kHz < 5,0 dB/km  
4 MHz < 22,0 dB/km  
16 MHz < 42,0 dB/km

150 Ohm ± 10 %  
74,5 Ohm/km  
2 GOhm x km  
149 Ohm/km max.  
36 nF/km nom.  
1,5 kV  
Frequency at +20°C at +200°C  
9,6 kHz < 3,0 dB/km < 8,0 dB/km  
38,4 kHz < 5,0 dB/km < 12,0 dB/km  
4 MHz < 22,0 dB/km < 41,0 dB/km  
16 MHz < 42,0 dB/km < 90,0 dB/km

## Technical data

Weight:  
bending radius, repeated:  
Operating temperature range min.:  
Operating temperature range max.:  
Caloric load, approx. value:  
Copper weight:

app. 69 kg/km  
120 mm  
-40°C  
+105°C  
0,99 MJ/m  
24,00 kg/km

app. 88 kg/km  
130 mm  
-50°C  
+200°C  
1,46 MJ/m  
28,00 kg/km

## Norms

Applicable standards:

Profibus acc. to DIN 19245 T3 and EN50170  
Flame-retardant acc. to IEC 60332-1-2

Profibus acc. to DIN 19245 T3 and EN50170  
Halogen-free acc. to 60754-2  
Flame-retardant acc. to IEC 60332-1-2

## Application

HELUKABEL® Profibus L2 105°C is for fixed installation indoor and enhanced temperature resistance.

The version Profibus L2 SR 200°C Fire Resistant has additional circuit integrity for 120 minutes (EN50200 PH120) and the temperature range up to +200°C for fix indoor installation.

## Part no.

**805705**, Profibus high temperature

**805706**, Profibus high temperature with circuit integrity

Dimensions and specifications may be changed without prior notice.



# BUS Cables

## Profibus L2 Drag Chain



PUR

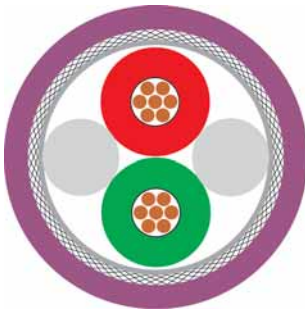

### Type

#### Cable structure

Inner conductor diameter:  
Core insulation:  
Core colours:  
Stranding element:  
Separator:  
Shielding 1:  
Total shielding:  
Outer sheath material:  
Cable external diameter:  
Outer sheath colour:

#### Drag Chain applications 1x2x0.64 mm (stranded)

Copper, bare (AWG 24/19)  
Foam-skin-PE  
rd, gn  
2 cores + 2 fillers stranded together  
Polyester foil over stranded bundle  
Al-Foil  
Cu braid, tinned  
PUR  
app. 8,0 mm ± 0,4 mm  
Violet similar to RAL 4001

#### Drag Chain applications 1x2x0.64 mm (stranded)

Copper, bare (AWG 24/19)  
Foam-skin-PE  
rd, gn  
2 cores + 2 fillers stranded together  
Polyester foil over stranded bundle  
Al-Foil  
Cu braid, tinned  
PUR  
app. 8,0 mm ± 0,4 mm  
Petrol similar to RAL 5018

### Electrical data

Characteristic impedance:  
Conductor resistance, max.:  
Insulation resistance, min.:  
Loop resistance:  
Mutual capacitance:  
Test voltage:  
Attenuation:

150 Ohm ± 10 %  
80 Ohm/km  
5 GOhm x km  
160 Ohm/km max.  
30 nF/km nom.  
1,5 kV  
9,6 kHz < 3,0 dB/km  
38,4 kHz < 5,0 dB/km  
4 MHz < 25,0 dB/km  
16 MHz < 52,0 dB/km

150 Ohm ± 10 %  
80 Ohm/km  
5 GOhm x km  
160 Ohm/km max.  
30 nF/km nom.  
1,5 kV  
9,6 kHz < 3,0 dB/km  
38,4 kHz < 5,0 dB/km  
4 MHz < 25,0 dB/km  
16 MHz < 52,0 dB/km

### Technical data

Weight:  
bending radius, repeated:  
Operating temperature range min.:  
Operating temperature range max.:  
Caloric load, approx. value:  
Copper weight:

app. 70 kg/km  
80 mm  
-30°C  
+70°C  
1,24 MJ/m  
25,00 kg/km

app. 70 kg/km  
80 mm  
-30°C  
+70°C  
1,24 MJ/m  
25,00 kg/km

### Norms

Applicable standards:

Profibus acc. to DIN 19245 T3 and EN50170  
Halogen-free acc. to 60754-2

Profibus acc. to DIN 19245 T3 and EN50170  
Halogen-free acc. to 60754-2

### Application

HELUKABEL® Profibus L2 Trailing cable for permanent moving in Drag Chain. Two jacket colours available - petrol or violet. All other technical parameters are the same.

### Part no.

**80267**, Profibus L2

**81003**, Profibus L2

Dimensions and specifications may be changed without prior notice.



# BUS Cables

Profibus Drag Chain ET200X + ECOFAST

**HELUKABEL®**

PUR

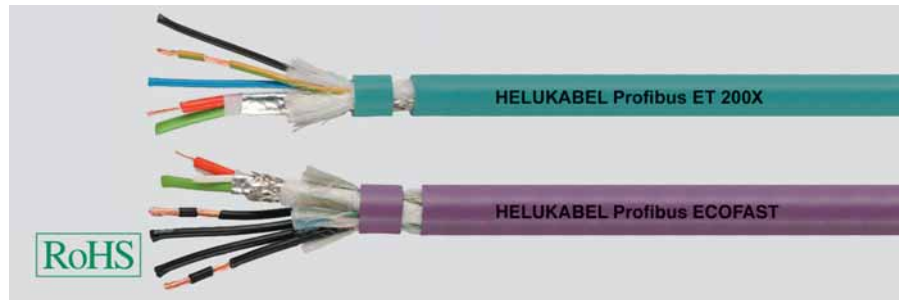
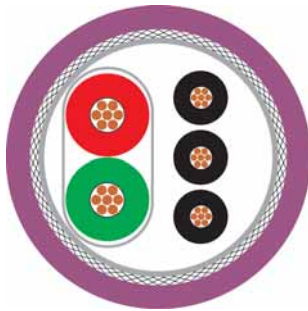

## Type Cable structure

Inner conductor diameter 1:  
Inner conductor diameter 2:  
Core insulation 1:  
Core insulation 2:  
Core colours 1:  
Core colours 2:  
Stranding element 1:  
Separator:  
Shielding 1:  
Total shielding:  
Outer sheath material:  
Cable external diameter:  
Outer sheath colour:

## Drag Chain applications 1x2x0.65 mm + 3x1x0.75 mm<sup>2</sup> (stranded)

Copper, bare (AWG 24/19)  
Copper, bare (AWG 18/42)  
Foam-skin-PE  
PE  
rd, gn  
bk, bu, gnye  
Double core  
Polyester foil over stranded bundle  
AL-Foil + braid  
Polyester foil  
PUR  
app. 9,7 mm ± 0,3 mm  
Petrol similar to RAL 5018

## Drag Chain applications 1x2x0.65 mm + 4x1x1.5 mm<sup>2</sup> (stranded)

Copper, bare (AWG 24/19)  
Copper, bare (AWG 18/85)  
Foam-skin-PE  
PE  
rd, gn  
bk, bk, bk, bk  
2 cores + 2 fillers stranded together  
Polyester foil over stranded bundle  
AL-Foil + braid  
-  
PUR  
app. 11,5 mm ± 0,3 mm  
Violet similar to RAL 4001

## Electrical data

Characteristic impedance:  
Conductor resistance, max.:  
Insulation resistance, min.:  
Loop resistance:  
Mutual capacitance:  
Test voltage:  
Relative propagation velocity:  
Attenuation:

150 Ohm ± 10 %  
73 Ohm/km  
5 GOhm x km  
145 Ohm/km max.  
30 nF/km nom.  
1,5 kV  
-  
9,6 kHz < 3,0 dB/km  
38,4 kHz < 5,0 dB/km  
4 MHz < 25,0 dB/km  
16 MHz < 52,0 dB/km

150 Ohm ± 15 %  
73 Ohm/km  
1 GOhm x km  
145 Ohm/km max.  
30 nF/km nom.  
1,5 kV  
81 %  
9,6 kHz ≤ 3,0 dB/km  
38,4 kHz ≤ 5,0 dB/km  
4 MHz ≤ 25,0 dB/km  
16 MHz ≤ 52,0 dB/km

## Technical data

Weight:  
bending radius, repeated:  
Operating temperature range min.:  
Operating temperature range max.:  
Caloric load, approx. value:  
Copper weight:

app. 106 kg/km  
145 mm  
-15°C  
+60°C  
1,953 MJ/m  
46,00 kg/km

app. 160 kg/km  
173 mm  
-15°C  
+60°C  
2,835 MJ/m  
90,00 kg/km

## Norms

Applicable standards:

Profibus acc. to DIN 19245 T3 and EN50170  
Halogen-free acc. to 60754-2  
Flame-retardant acc. to IEC 60332-1-2  
AWM Style 20236 AWM I/II A/B 80°C 30V  
FT1

Profibus acc. to DIN 19245 T3 and EN50170  
Halogen-free acc. to 60754-2  
Flame-retardant acc. to IEC 60332-1-2  
UL Style 20233

UL Style:

## Application

HELUKABEL® Profibus ET200X + Ecofast Hybrid cables are designed for continuous motion in cable carriers. The hybrid construction integrates the power supply next to the Profibus in one cable. The type ET200X offers three 0,75mm<sup>2</sup> power conductors, while the type Ecofast 4 has 1,5mm<sup>2</sup> power conductors and greater current-carrying capacity.

## Part no.

**82913**, Profibus L2

**800044**, Profibus L2

Dimensions and specifications may be changed without prior notice.

# BUS Cables

Profibus fixed installed SHIPLINE + High Temperature 180°C

 **HELUKABEL®**

X-FRNC + FEP

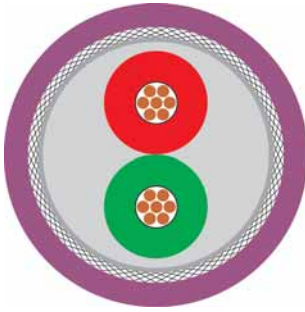

## Type

### Cable structure

Inner conductor diameter:  
Core insulation:  
Core colours:  
Stranding element:  
Separator:  
Inner sheath material:  
Shielding 1:  
Total shielding:  
Outer sheath material:  
Cable external diameter:  
Outer sheath colour:

### Marine and Offshore 1x2x0.75 mm (stranded)

Copper, bare (AWG 22/7)  
Foam-skin-PE  
rd, gn  
Double core  
Polyester foil over stranded bundle  
FRNC  
Al-Foil  
Cu braid, tinned  
X-FRNC  
app. 8,0 mm ± 0,4 mm  
Violet similar to RAL 4001

### High temperature areas 1x2x0.64 mm

Copper, bare (AWG 22/1)  
FEP  
rd, gn  
2 cores + 2 fillers stranded together  
-  
Al-Foil  
Cu braid, tinned  
FEP  
app. 7,2 mm ± 0,3 mm  
Violet similar to RAL 4001

## Electrical data

Characteristic impedance:  
Conductor resistance, max.:  
Insulation resistance, min.:  
Loop resistance:  
Mutual capacitance:  
Nominal voltage:  
Test voltage:  
Attenuation:

150 Ohm ± 10 %  
55 Ohm/km  
1,6 GOhm x km  
110 Ohm/km max.  
29 nF/km nom.  
60 V  
1 kV  
9,6 kHz < 2,5 dB/km  
38,4 kHz < 4,0 dB/km  
4 MHz < 22,0 dB/km  
16 MHz < 42,0 dB/km

150 Ohm ± 10 %  
55 Ohm/km  
1,6 GOhm x km  
110 Ohm/km max.  
28 nF/km nom.  
250 V  
3,6 kV  
9,6 kHz < 2,5 dB/km  
38,4 kHz < 4,0 dB/km  
4 MHz < 22,0 dB/km  
16 MHz < 42,0 dB/km

## Technical data

Weight:  
bending radius, repeated:  
Operating temperature range min.:  
Operating temperature range max.:  
Caloric load, approx. value:  
Copper weight:

app. 84 kg/km  
80 mm  
-25°C  
+80°C  
1,26 MJ/m  
35,00 kg/km

app. 64 kg/km  
52 mm  
-50°C  
+180°C  
0,30 MJ/m  
24,00 kg/km

## Norms

Applicable standards:

Profibus acc. to DIN 19245 T3 and EN50170  
Halogen-free acc. to 60754-2  
Flame-retardant acc. to IEC 60332-1-2

Profibus acc. to DIN 19245 T3 and EN50170  
Flame-retardant acc. to IEC 60332-3

## Application

HELUKABEL® Profibus Shipline is designed for marine/offshore applications and **certified by German Lloyd**. Thanks to use of stranded conductors, this cable can be moved occasionally. The High-Temperature version is used in fixed installations with demanding temperature requirements, e.g. in the vicinity of a hot furnace or near welding activities.

## Part no.

**802178**, Profibus SHIPLINE

**802179**, Profibus high temperature

Dimensions and specifications may be changed without prior notice.

# BUS Cables

DESINA®-HYBRID-BUS Drag Chain hybrid



PUR

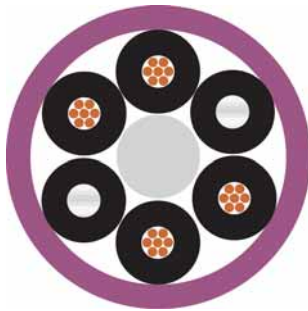

## Type

### Cable structure

Conductor material  
Core insulation:  
Polymer optical fibre:  
Core colours:  
Core identification:  
Total shielding:  
Outer sheath material:  
Cable external diameter:  
Outer sheath colour:

## Hybrid Bus Cable

### 4x1.5 mm<sup>2</sup> + 2xPOF

Copper, bare, KL.6 = extra fine wire  
TPM  
4x POF 980/1000  
Black  
Numbers  
PETP fleece  
TPU  
app. 8,8 mm ± 0,3 mm  
Violet similar to RAL 4001

## Electrical data

Conductor resistance, max.:  
Insulation resistance, min.:  
Test voltage:

13,7 Ohm/km  
0,5 GOhm x km  
3 kV

## Optical characteristic

Fibre attenuation:

230 dB/km max. at 650 nm

## Technical data

Weight:  
bending radius, repeated:  
Operating temperature range min.:  
Operating temperature range max.:  
Copper weight:

app. 120 kg/km  
130 mm  
-20°C  
+80°C  
60,00 kg/km

## Norms

Applicable standards:

Detail specification for DESINA

## Application

HELUKABEL® DESINA®-Hybrid-Bus is used for mobile applications in machinery. Use of a TPU sheath provides excellent resistance to common mineral oils, greases and cooling lubricants in industrial automation.

## Part no.

**81713**, DESINA HYBRID BUS

Dimensions and specifications may be changed without prior notice.

# BUS Cables

Profibus L2 high flexible TORSION + FESTOON

**HELUKABEL®**

PUR + PVC

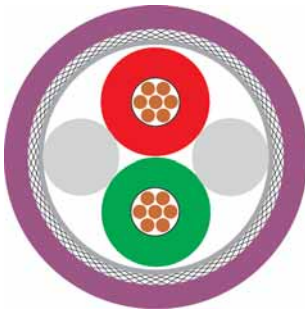

## Type

### Cable structure

Inner conductor diameter:  
Core insulation:  
Core colours:  
Stranding element:  
Separator:  
Shielding 1:  
Total shielding:  
Outer sheath material:  
Cable external diameter:  
Outer sheath colour:

## Torsional applications

### 1x2x0.80 mm (stranded)

Copper, bare (AWG 22/19)  
Foam-skin-PE  
rd, gn  
2 cores + filler  
Polyester foil over stranded bundle  
Al-Foil  
Cu braid, tinned  
PUR  
app. 8,0 mm ± 0,4 mm  
Violet similar to RAL 4001

## Mobile use

### 1x2x0.65 mm (stranded)

Copper, bare (AWG 23/19)  
Cell PE  
rd, gn  
2 cores + 2 fillers stranded together  
Polyester foil over stranded bundle  
Al-Foil  
Cu braid, tinned  
PVC  
app. 8,0 mm ± 0,3 mm  
Petrol similar to RAL 5018

## Electrical data

Characteristic impedance:  
Conductor resistance, max.:  
Insulation resistance, min.:  
Loop resistance:  
Mutual capacitance:  
Test voltage:  
Relative propagation velocity:  
Attenuation:

150 Ohm ± 10 %  
49 Ohm/km  
1,6 GOhm x km  
98 Ohm/km max.  
29 nF/km nom.  
3,6 kV  
-  
9,6 kHz < 2,5 dB/km  
38,4 kHz < 3,0 dB/km  
4 MHz < 25,0 dB/km  
16 MHz < 49,0 dB/km

150 Ohm ± 10 %  
66,5 Ohm/km  
1,6 GOhm x km  
133 Ohm/km max.  
28 nF/km nom.  
2 kV  
81 %  
9,6 kHz ≤ 3,0 dB/km  
38,4 kHz ≤ 4,0 dB/km  
4 MHz ≤ 25,0 dB/km  
16 MHz ≤ 49,0 dB/km

## Technical data

Weight:  
bending radius, repeated:  
Operating temperature range min.:  
Operating temperature range max.:  
Caloric load, approx. value:  
Copper weight:

app. 66 kg/km  
32 mm  
-25°C  
+75°C  
0,89 MJ/m  
32,00 kg/km

app. 64 kg/km  
70 mm  
-40°C  
+60°C  
1,09 MJ/m  
23,00 kg/km

## Norms

Applicable standards:

Profibus acc. to DIN 19245 T3 and EN50170  
Halogen-free acc. to 60754-2  
Flame-retardant acc. to IEC 60332-1-2  
CMX 75°C (shielded)  
-

Profibus acc. to DIN 19245 T3 and EN50170  
Flame-retardant acc. to EN 50265-2-1

UL Style:  
CSA standard:

CMG 75°C or CL2 or AWM 20201 600V  
CSA FT 4

## Application

HELUKABEL® Profibus Torsion is used in mobile applications in robots. The special torsion construction allows this cable to be twisted (torsioned) and is halogen-free thanks to use PU sheath. The Festoon version is used for hanging/moving loads in garland applications.

## Part no.

**800109**, Profibus L2

**800649**, Profibus L2

Dimensions and specifications may be changed without prior notice.

# BUS Cables

Profibus PA fixed installed

**HELUKABEL®**

PVC

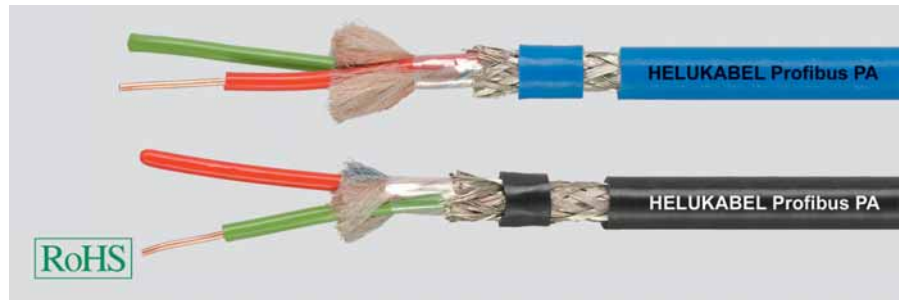
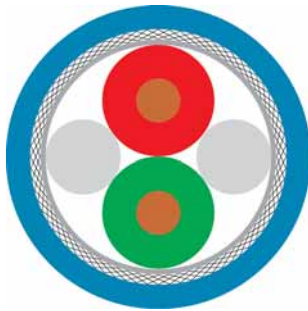

## Type

### Cable structure

Inner conductor diameter:  
Core insulation:  
Core colours:  
Stranding element:  
Separator:  
Shielding 1:  
Total shielding:  
Outer sheath material:  
Cable external diameter:  
Outer sheath colour:

## Hazardous areas

### 1x2x1.0/2.55 mm

Copper, bare (AWG 18/1)  
PE  
rd, gn  
2 cores + 2 fillers stranded together  
Polyester foil over stranded bundle  
Al-Foil  
Cu braid, tinned  
PVC  
app. 7,6 mm ± 0,2 mm  
Blue

## Non-hazardous areas

### 1x2x1.0/2.55 mm

Copper, bare (AWG 18/1)  
PE  
rd, gn  
2 cores + 2 fillers stranded together  
Polyester foil over stranded bundle  
Al-Foil  
Cu braid, tinned  
PVC  
app. 7,6 mm ± 0,2 mm  
Black

## Electrical data

Characteristic impedance:  
Conductor resistance, max.:  
Insulation resistance, min.:  
Loop resistance:  
Mutual capacitance:  
Nominal voltage:  
Test voltage:  
Attenuation:

100 Ohm ± 20 %  
22 Ohm/km  
1 GOhm x km  
44 Ohm/km max.  
60 nF/km nom.  
300 V  
2,5 kV  
39 kHz ≤ 3,0 dB/km

100 Ohm ± 20 %  
22 Ohm/km  
1 GOhm x km  
44 Ohm/km max.  
60 nF/km nom.  
300 V  
2,5 kV  
39 kHz ≤ 3,0 dB/km

## Technical data

Weight:  
bending radius, repeated:  
Operating temperature range min.:  
Operating temperature range max.:  
Caloric load, approx. value:  
Copper weight:

app. 76 kg/km  
140 mm  
-30°C  
+80°C  
0,95 MJ/m  
44,00 kg/km

app. 76 kg/km  
140 mm  
-30°C  
+80°C  
0,95 MJ/m  
44,00 kg/km

## Norms

Applicable standards:  
UL Style:

Profibus acc. to DIN 19245 T3 and EN50170  
Flame-retardant acc. to EN 50265-2-1  
UL Style 2571

Profibus acc. to DIN 19245 T3 and EN50170  
Flame-retardant acc. to EN 50265-2-1  
UL Style 2571

## Application

HELUKABEL® Profibus PA is used for normal requirements in the process automation field (chemical industry). The colour blue identifies it as suitable for use in potentially explosive areas (and ATEX/ Class II, EX-i/ EN 60079-14). For other applications, the colour black is usually selected.

## Part no.

**82835**, Profibus PA

**82836**, Profibus PA

Dimensions and specifications may be changed without prior notice.

# BUS Cables

Profibus PA fixed installed armoured

**HELUKABEL®**

PVC / PVC

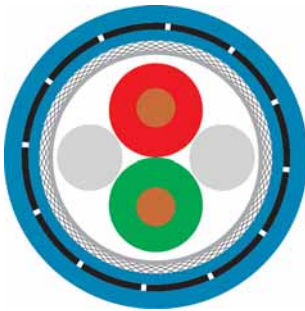

## Type

### Cable structure

Inner conductor diameter:  
Core insulation:  
Core colours:  
Stranding element:  
Separator:  
Inner sheath material:  
Shielding 1:  
Total shielding:  
Armouring:  
Outer sheath material:  
Cable external diameter:  
Outer sheath colour:

### Hazardous areas 1x2x1.0/2.55 mm

Copper, bare (AWG 18/1)  
PE  
rd, gn  
2 cores + 2 fillers stranded together  
Polyester foil over stranded bundle  
PVC  
Al-Foil  
Cu braid, tinned  
Steel band  
PVC  
app. 10,2 mm ± 0,2 mm  
Blue

### Non-hazardous areas 1x2x1.0/2.55 mm

Copper, bare (AWG 18/1)  
PE  
rd, gn  
2 cores + 2 fillers stranded together  
Polyester foil over stranded bundle  
PVC  
Al-Foil  
Cu braid, tinned  
Steel band  
PVC  
app. 10,2 mm ± 0,2 mm  
Black

## Electrical data

Characteristic impedance:  
Conductor resistance, max.:  
Insulation resistance, min.:  
Loop resistance:  
Mutual capacitance:  
Nominal voltage:  
Test voltage:  
Attenuation:

100 Ohm ± 15 %  
22 Ohm/km  
1 GOhm x km  
44 Ohm/km max.  
55 nF/km nom.  
300 V  
2,5 kV  
39 kHz ≤ 3,0 dB/km

100 Ohm ± 15 %  
22 Ohm/km  
1 GOhm x km  
44 Ohm/km max.  
55 nF/km nom.  
300 V  
2,5 kV  
39 kHz ≤ 3,0 dB/km

## Technical data

Weight:  
bending radius, repeated:  
Operating temperature range min.:  
Operating temperature range max.:  
Caloric load, approx. value:  
Copper weight:

app. 170 kg/km  
140 mm  
-20°C  
+70°C  
1,95 MJ/m  
45,00 kg/km

app. 170 kg/km  
200 mm  
-20°C  
+70°C  
1,95 MJ/m  
45,00 kg/km

## Norms

Applicable standards:

Profibus acc. to DIN 19245 T3 and EN50170  
Flame-retardant acc. to EN 50265-2-1

Profibus acc. to DIN 19245 T3 and EN50170  
Flame-retardant acc. to EN 50265-2-1

## Application

HELUKABEL® Profibus PA Armoured is used in areas with rodent such as rats, nutria etc. but also offers additional protection against all other outside mechanical influences thanks to its steel tape armouring. The colour blue identifies it as suitable for use in potentially explosive areas (and ATEX/ Class II, EX-i/EN 60079-14). For other applications, the colour black is usually used.

## Part no.

**802180**, Profibus PA

**802181**, Profibus PA

Dimensions and specifications may be changed without prior notice.

# BUS Cables

Profibus PA LD fixed installed

**HELUKABEL®**

PVC

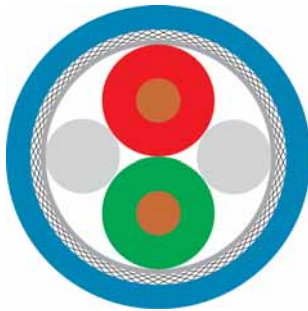

## Type

### Cable structure

Inner conductor diameter:  
Core insulation:  
Core colours:  
Stranding element:  
Separator:  
Shielding 1:  
Total shielding:  
Outer sheath material:  
Cable external diameter:  
Outer sheath colour:

## Hazardous areas

### 1x2x1.6/3.2 mm

Copper, bare (AWG 16/7)  
Foam-skin-PE  
rd, gn  
2 cores + 2 fillers stranded together  
Polyester foil over stranded bundle  
Al-Foil  
Cu braid, tinned  
PVC  
app. 9,5 mm ± 0,3 mm  
Blue

## Non-hazardous areas

### 1x2x1.6/3.2 mm

Copper, bare (AWG 16/7)  
Foam-skin-PE  
rd, gn  
2 cores + 2 fillers stranded together  
Polyester foil over stranded bundle  
Al-Foil  
Cu braid, tinned  
PVC  
app. 9,5 mm ± 0,3 mm  
Black

## Electrical data

Characteristic impedance:  
Conductor resistance, max.:  
Insulation resistance, min.:  
Loop resistance:  
Mutual capacitance:  
Nominal voltage:  
Test voltage:  
Attenuation:

100 Ohm ± 20 %  
24 Ohm/km  
1 GOhm x km  
48 Ohm/km max.  
60 nF/km nom.  
300 V  
1 kV  
39 kHz ≤ 2,7 dB/km

100 Ohm ± 20 %  
24 Ohm/km  
1 GOhm x km  
48 Ohm/km max.  
60 nF/km nom.  
300 V  
1 kV  
39 kHz ≤ 2,7 dB/km

## Technical data

Weight:  
bending radius, repeated:  
Operating temperature range min.:  
Operating temperature range max.:  
Caloric load, approx. value:  
Copper weight:

app. 131 kg/km  
100 mm  
-40°C  
+70°C  
1,57 MJ/m  
62,00 kg/km

app. 131 kg/km  
100 mm  
-40°C  
+70°C  
1,57 MJ/m  
62,00 kg/km

## Norms

Applicable standards:

UL Style:

Profibus acc. to DIN 19245 T3 and EN50170  
Flame-retardant acc. to IEC 60332-1-2  
UL Style 2571

Profibus acc. to DIN 19245 T3 and EN50170  
Flame-retardant acc. to IEC 60332-1-2  
UL Style 2571

## Application

HELUKABEL® Profibus PA Long Distance is used for especially long transmission distances in process networks. It uses a larger conductor cross-section to satisfy the attenuation requirements. The colour blue identifies it as suitable for use in potentially explosive areas (and ATEX/Class II, EX-i/EN 60079-14). For other applications, the colour black is usually selected.

## Part no.

**800650**, Profibus PA

**800715**, Profibus PA

Dimensions and specifications may be changed without prior notice.

# BUS Cables

Profibus SK fixed installed Indoor + Outdoor

**HELUKABEL®**

PVC + PE

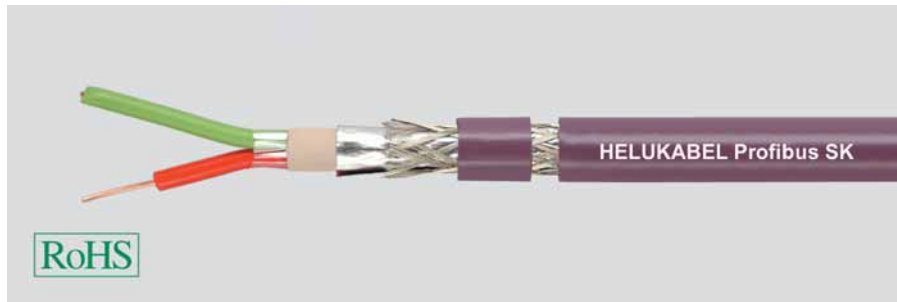
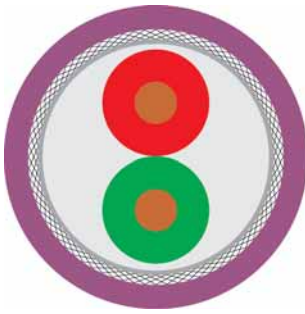

## Type

### Cable structure

Inner conductor diameter:  
Core insulation:  
Core colours:  
Stranding element:  
Separator:  
Inner sheath material:  
Shielding 1:  
Total shielding:  
Outer sheath material:  
Cable external diameter:  
Outer sheath colour:

### Fixed installation, indoor 1x2x0.64 mm

Copper, bare (AWG 22/1)  
Foam-skin-PE  
rd, gn  
Double core  
Polyester foil over stranded bundle  
PVC  
Al-Foil  
Cu braid, tinned  
PVC  
app. 8,0 mm ± 0,4 mm  
Violet similar to RAL 4001

### Fixed installation, outdoor 1x2x0.64 mm

Copper, bare (AWG 22/1)  
Foam-skin-PE  
rd, gn  
Double core  
Polyester foil over stranded bundle  
PVC  
Al-Foil  
Cu braid, tinned  
PE  
app. 8,0 mm ± 0,4 mm  
Black similar to RAL 9005

## Electrical data

Characteristic impedance:  
Conductor resistance, max.:  
Insulation resistance, min.:  
Loop resistance:  
Mutual capacitance:  
Test voltage:  
Attenuation:

150 Ohm ± 10 %  
55 Ohm/km  
1 GOhm x km  
110 Ohm/km max.  
35 nF/km nom.  
1,5 kV  
9,6 kHz < 2,5 dB/km  
38,4 kHz < 4,0 dB/km  
4,0 MHz < 22,0 dB/km  
16,0 MHz < 42,0 dB/km

150 Ohm ± 10 %  
55 Ohm/km  
1 GOhm x km  
110 Ohm/km max.  
35 nF/km nom.  
1,5 kV  
9,6 kHz < 2,5 dB/km  
38,4 kHz < 4,0 dB/km  
4 MHz < 22,0 dB/km  
16 MHz < 42,0 dB/km

## Technical data

Weight:  
bending radius, repeated:  
Operating temperature range min.:  
Operating temperature range max.:  
Caloric load, approx. value:  
Copper weight:

app. 79 kg/km  
120 mm  
-40°C  
+80°C  
1,068 MJ/m  
24,00 kg/km

app. 65 kg/km  
120 mm  
-20°C  
+70°C  
1,451 MJ/m  
24,00 kg/km

## Norms

Applicable standards:

UL Style:  
CSA standard:

Profibus acc. to DIN 19245 T3 and EN50170  
Flame-retardant acc. to IEC 60332-3  
CMG 75°C or CL3 or AWM 21694 600V  
CSA FT 4

Profibus acc. to DIN 19245 T3 and EN50170  
Halogen-free acc. to 60754-2  
-  
-

## Application

HELUKABEL® Profibus SK Indoor + Outdoor have a special structure for processing with the Fast Connect Stripping Tool from Siemens. The indoor version is used for normal requirements in fixed installation applications in equipment; the Outdoor version is used in open-air applications, i.e. can withstand wind, weather and sun (not for burial directly in the ground).

## Part no.

**81903**, Profibus SK

**81904**, Profibus SK

Dimensions and specifications may be changed without prior notice.



# BUS Cables

Profibus SK fixed installed FRNC + Robust

**HELUKABEL®**

FRNC + PUR

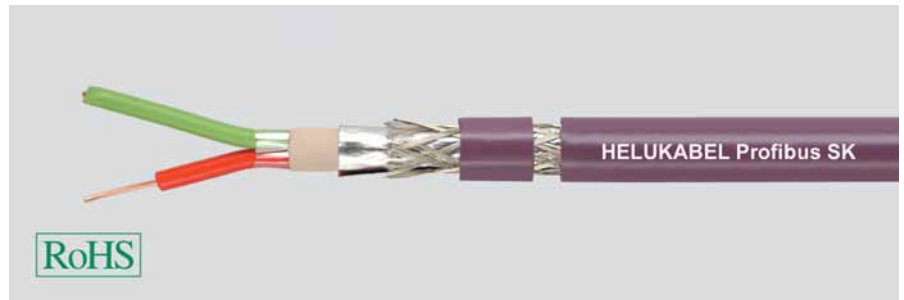
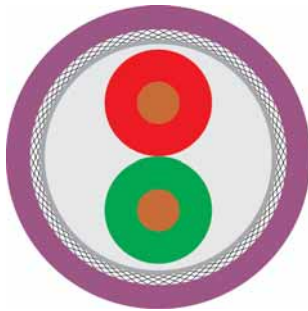

## Type

### Cable structure

Inner conductor diameter:  
Core insulation:  
Core colours:  
Stranding element:  
Separator:  
Inner sheath material:  
Shielding 1:  
Total shielding:  
Outer sheath material:  
Cable external diameter:  
Outer sheath colour:

## Fixed installation, indoor

### 1x2x0.64 mm

Copper, bare (AWG 22/1)  
Foam-skin-PE  
rd, gn  
Double core  
Polyester foil over stranded bundle  
FRNC  
Al-Foil  
Cu braid, tinned  
FRNC  
app. 8,0 mm ± 0,4 mm  
Violet similar to RAL 4001

## Industrial Area

### 1x2x0.64 mm

Copper, bare (AWG 22/1)  
Foam-skin-PE  
rd, gn  
Double core  
Polyester foil over stranded bundle  
FRNC  
Al-Foil  
Cu braid, tinned  
PUR  
app. 8,0 mm ± 0,4 mm  
Violet similar to RAL 4001

## Electrical data

Characteristic impedance:  
Conductor resistance, max.:  
Insulation resistance, min.:  
Loop resistance:  
Mutual capacitance:  
Test voltage:  
Attenuation:

150 Ohm ± 10 %  
55 Ohm/km  
1 GOhm x km  
110 Ohm/km max.  
35 nF/km nom.  
1,5 kV  
9,6 kHz < 2,5 dB/km  
38,4 kHz < 4,0 dB/km  
4 MHz < 22,0 dB/km  
16 MHz < 42,0 dB/km

150 Ohm ± 10 %  
55 Ohm/km  
1 GOhm x km  
110 Ohm/km max.  
35 nF/km nom.  
1,5 kV  
9,6 kHz < 2,5 dB/km  
38,4 kHz < 4,0 dB/km  
4 MHz < 22,0 dB/km  
16 MHz < 42,0 dB/km

## Technical data

Weight:  
bending radius, repeated:  
Operating temperature range min.:  
Operating temperature range max.:  
Caloric load, approx. value:  
Copper weight:

app. 73 kg/km  
160 mm  
-25°C  
+70°C  
1,203 MJ/m  
24,00 kg/km

app. 71 kg/km  
120 mm  
-40°C  
+70°C  
1,574 MJ/m  
24,00 kg/km

## Norms

Applicable standards:

Profibus acc. to DIN 19245 T3 and EN50170  
Halogen-free acc. to 60754-2  
Flame-retardant acc. to EN 50265-2-1  
CM 750C (shielded)

Profibus acc. to DIN 19245 T3 and EN50170  
Halogen-free acc. to 60754-2  
Flame-retardant acc. to IEC 60332-1-2  
AWM Style 20236 AWM I/II A/B 80°C 30V  
FT1  
CSA FT1

UL Style:

CSA standard:

## Application

HELUKABEL® Profibus SK FRNC + Robust has a special structure for processing with the Fast Connect Stripping Tool from Siemens. The FRNC version is used to satisfy halogen-free and flame-retardant requirements in buildings. The Robust version is used in harsh industrial environments and offers excellent resistance to mineral oils, greases and cooling lubricants.

## Part no.

**81501**, Profibus SK

**81905**, Profibus SK

Dimensions and specifications may be changed without prior notice.

# BUS Cables

Profibus fixed installed FRNC

**HELUKABEL®**

PH 120

NEW

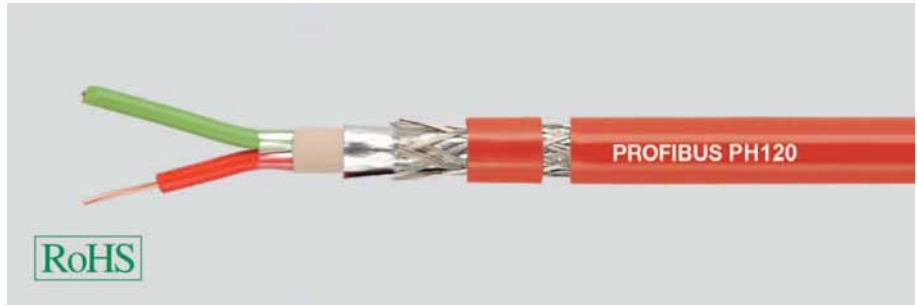
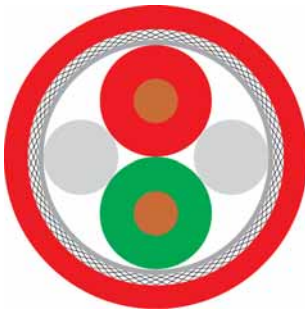

## Type

### Cable structure

Inner conductor diameter:  
Core insulation:  
Core colours:  
Stranding element:  
Separator:  
Shielding 1:  
Total shielding:  
Outer sheath material:  
Cable external diameter:  
Outer sheath colour:

## Fixed installation, indoor

### 1x2x0.64 mm

Copper, bare (AWG 22/1)  
Foam-skin-PE  
rd, gn  
Double core  
-  
-  
AL-Foil + braid  
FRNC  
app. 8,4 mm ± 0,3 mm  
Red

## Electrical data

Characteristic impedance:  
Conductor resistance, max.:  
Insulation resistance, min.:  
Loop resistance:  
Mutual capacitance:  
Test voltage:  
Attenuation:

150 Ohm ± 10 %  
59,1 Ohm/km  
1 GOhm x km  
118 Ohm/km max.  
30 nF/km nom.  
0,7 kV

Frequency	before EN50200	after EN50200 PH120
9,6 kHz	2,1 dB/km	2,3 dB/km
38,4 kHz	3,0 dB/km	3,3 dB/km
4 MHz	18,5 dB/km	20,4 dB/km
16 MHz	34,5 dB/km	38,0 dB/km

## Technical data

Weight:  
bending radius, repeated:  
Operating temperature range min.:  
Operating temperature range max.:  
Caloric load, approx. value:  
Copper weight:

app. 93 kg/km  
130 mm  
-20°C  
+70°C  
1,46 MJ/m  
33,00 kg/km

## Norms

Applicable standards:

Profibus acc. to DIN 19245 T3 and EN50170  
Halogen-free acc. to 60754-2  
Flame-retardant acc. to EN 50265-2-1

## Application

HELUKABEL® Profibus FRNC PH120 has a special structure for circuit integrity for 120 minutes and is used for fix installation in buildings.

## Part no.

**805695**, Profibus Circuit Integrity

Dimensions and specifications may be changed without prior notice.

# BUS Cables

## Profibus SK Drag Chain



PUR

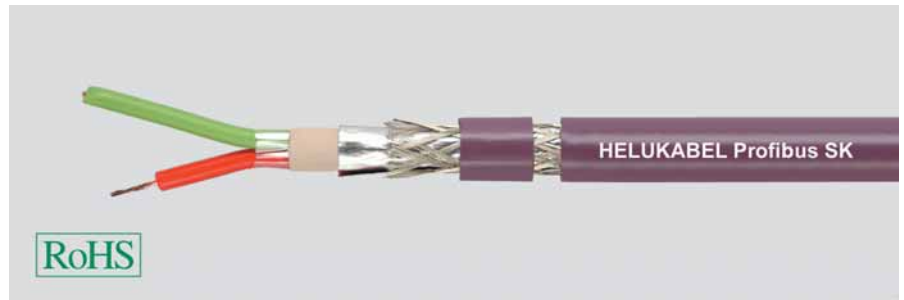
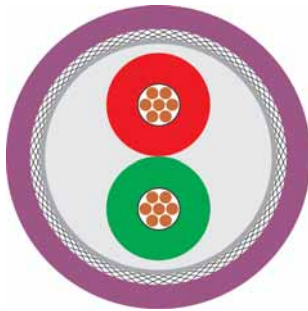

### Type Cable structure

Inner conductor diameter:  
Core insulation:  
Core colours:  
Stranding element:  
Separator:  
Inner sheath material:  
Shielding 1:  
Total shielding:  
Outer sheath material:  
Cable external diameter:  
Outer sheath colour:

### Drag Chain applications 1x2x0.65 mm (stranded)

Copper, bare (AWG 24/19)  
Foam-skin-PE  
rd, gn  
Double core  
Polyester foil over stranded bundle  
PVC  
Al-Foil  
Cu braid, tinned  
PUR  
app. 8,0 mm ± 0,4 mm  
Violet similar to RAL 4001

### Drag Chain applications 1x2x0.65 mm (stranded)

Copper, bare (AWG 24/19)  
Foam-skin-PE  
rd, gn  
Double core  
Polyester foil over stranded bundle  
PVC  
Al-Foil  
Cu braid, tinned  
PUR  
app. 8,0 mm ± 0,4 mm  
Petrol similar to RAL 5018

### Electrical data

Characteristic impedance:  
Conductor resistance, max.:  
Insulation resistance, min.:  
Loop resistance:  
Mutual capacitance:  
Test voltage:  
Attenuation:

150 Ohm ± 10 %  
67 Ohm/km  
1 GOhm x km  
134 Ohm/km max.  
35 nF/km nom.  
1,5 kV  
9,6 kHz < 3,0 dB/km  
38,4 kHz < 5,0 dB/km  
4 MHz < 25,0 dB/km  
16 MHz < 52,0 dB/km

150 Ohm ± 10 %  
67 Ohm/km  
1 GOhm x km  
134 Ohm/km max.  
35 nF/km nom.  
1,5 kV  
9,6 kHz < 3,0 dB/km  
38,4 kHz < 5,0 dB/km  
4 MHz < 25,0 dB/km  
16 MHz < 52,0 dB/km

### Technical data

Weight:  
bending radius, repeated:  
Operating temperature range min.:  
Operating temperature range max.:  
Caloric load, approx. value:  
Copper weight:

app. 70 kg/km  
100 mm  
-40°C  
+70°C  
1,53 MJ/m  
25,00 kg/km

app. 70 kg/km  
100 mm  
-40°C  
+70°C  
1,53 MJ/m  
25,00 kg/km

### Norms

Applicable standards:  
UL Style:  
CSA standard:

Profibus acc. to DIN 19245 T3 and EN50170  
Flame-retardant acc. to IEC 60332-1-2  
CMX 75°C (shielded)  
CSA FT1

Profibus acc. to DIN 19245 T3 and EN50170  
Flame-retardant acc. to IEC 60332-1-2  
CMX 75°C (shielded)  
CSA FT1

### Application

HELUKABEL® Profibus SK Drag Chain is designed for continuous motion in cable carriers and has a special structure for processing with the Fast Connect Stripping Tool from Siemens. Thanks to the PU sheath, it also offers excellent resistance to common mineral oils, greases and cooling lubricants. Depending on the application, the colour petrol or violet is available.

### Part no.

**801659**, Profibus SK

**81906**, Profibus SK

Dimensions and specifications may be changed without prior notice.

# BUS Cables

FOUNDATION™ Fieldbus flexible Basic

**HELUKABEL®**

PVC

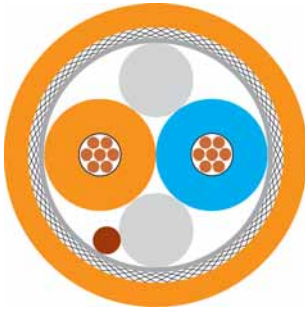

## Type

### Cable structure

Inner conductor diameter:  
Core insulation:  
Core colours:  
Stranding element:  
Separator:  
Shielding 1:  
Total shielding:  
Drain wire:  
Outer sheath material:  
Cable external diameter:  
Outer sheath colour:

## process automation

### 1x2x1.1/2, 55-100 LI

Copper, bare (AWG 18/7)  
PO  
or, bl  
2 cores + 2 fillers stranded together  
Polyester foil over stranded bundle  
Al-Foil  
Cu braid, tinned  
yes  
PVC  
app. 8,0 mm ± 0,3 mm  
Orange

## Electrical data

Characteristic impedance: 100 Ohm ± 20 Ohm  
Conductor resistance, max.: 22 Ohm/km  
Insulation resistance, min.: 5 GOhm x km  
Loop resistance: 44 Ohm/km max.  
Mutual capacitance: 60 nF/km nom.  
Nominal voltage: 300 V  
Test voltage: 1,5 kV  
Attenuation: 39 kHz ≤ 3,4 dB/km

## Technical data

Weight: app. 85 kg/km  
bending radius, repeated: 80 mm  
Operating temperature range min.: -40°C  
Operating temperature range max.: +80°C  
Caloric load, approx. value: 1,22 MJ/m  
Copper weight: 45,00 kg/km

## Norms

Applicable standards: Foundation Fieldbus Spec. FF-816-1.4  
Flame-retardant acc. to IEC 60332-3  
UL Style: CMG 75°C PLTC FT4  
CSA standard: CSA FT 4

## Application

HELUKABEL® FOUNDATION™ Fieldbus Basic for normal requirements in this industrial networks. Thanks to use of stranded conductors, this cable can be moved occasionally and satisfies the usual American requirements for such networks.

## Part no.

**803354**, Foundation™ Fieldbus Basic

Dimensions and specifications may be changed without prior notice.

# BUS Cables

FOUNDATION™ Fieldbus flexible Type A + gnye

**HELUKABEL®**

PVC



## Type

### Cable structure

Inner conductor diameter 1:  
Inner conductor diameter 2:  
Core insulation 1:  
Core insulation 2:  
Core colours 1:  
Core colours 2:  
Stranding element 1:  
Separator:  
Shielding 1:  
Total shielding:  
Drain wire:  
Outer sheath material:  
Cable external diameter:  
Outer sheath colour:

## process automation

### 1x2x1.1/2, 85-100 LI + 1x0,8 gnye

Copper, bare (AWG 18/41)  
Copper, bare (AWG 18/41)  
XLPE ray cross-linking  
PVC  
bu, bn  
gn/ye  
Double core  
-  
Al-Foil  
Cu braid, tinned  
yes  
PVC  
app. 7,9 mm ± 0,3 mm  
Yellow

## Electrical data

Characteristic impedance: 100 Ohm ± 20 Ohm  
Conductor resistance, max.: 24 Ohm/km  
Insulation resistance, min.: 2 GOhm x km  
Loop resistance: 48 Ohm/km max.  
Mutual capacitance: 65 nF/km nom.  
Nominal voltage: 300 V  
Test voltage: 1,5 kV  
Attenuation: 39 kHz ≤ 3,4 dB/km

## Technical data

Weight: app. 84 kg/km  
bending radius, repeated: 80 mm  
Operating temperature range min.: -25°C  
Operating temperature range max.: +105°C  
Caloric load, approx. value: 1,00 MJ/m  
Copper weight: 49,00 kg/km

## Norms

Applicable standards: Foundation Fieldbus Spec. FF-816-1.4  
Flame-retardant acc. to IEC 60332-3  
UL Style: CMG 105° or CL3 FT4  
CSA standard: CSA FT 4

## Application

HELUKABEL® FOUNDATION™ Fieldbus Type A + gnye offers an additional conductor in the structure in compliance with the FF specification. Thanks to use of stranded conductors, this cable can be moved occasionally and satisfies the usual American requirements for such networks.

## Part no.

**801191**, Foundation Fieldbus FF A

Dimensions and specifications may be changed without prior notice.

# BUS Cables

FOUNDATION™ Fieldbus flexible Type A armoured

 **HELUKABEL®**

PVC



## Type

### Cable structure

Inner conductor diameter 1:  
Inner conductor diameter 2:  
Core insulation 1:  
Core insulation 2:  
Core colours 1:  
Core colours 2:  
Stranding element 1:  
Separator:  
Shielding 1:  
Total shielding:  
Drain wire:  
Armouring:  
Outer sheath material:  
Cable external diameter:  
Outer sheath colour:

### process automation

#### 1x2x1.1/2, 85-100 LI + 1x0,8 gnye, armoured

Copper, bare (AWG 18/41)  
Copper, bare (AWG 18/37)  
XLPE ray cross-linking  
PVC  
bu, bn  
gn/ye  
Double core  
-  
Al-Foil  
Al-Foil  
yes  
Corrugated copper tube  
PVC  
app. 12,3 mm ± 0,3 mm  
Yellow

### Electrical data

Characteristic impedance: 100 Ohm ± 20 Ohm  
Conductor resistance, max.: 24 Ohm/km  
Insulation resistance, min.: 2 GOhm x km  
Loop resistance: 48 Ohm/km max.  
Mutual capacitance: 65 nF/km nom.  
Nominal voltage: 300 V  
Test voltage: 1,5 kV  
Attenuation: 39 kHz ≤ 3,4 dB/km

### Technical data

Weight: app. 187 kg/km  
bending radius, repeated: 130 mm  
Operating temperature range min.: -25°C  
Operating temperature range max.: +105°C  
Caloric load, approx. value: 1,65 MJ/m  
Copper weight: 125,00 kg/km

### Norms

Applicable standards: Foundation Fieldbus Spec. FF-816-1.4  
Flame-retardant acc. to IEC 60332-3  
UL Style: CMG 105°C or PLTC FT4 Sun Res  
CSA standard: CSA FT 4

### Application

HELUKABEL® FOUNDATION™ Type A Armoured finds use in areas with rodents such as rats, nutria etc. but also offers additional protection against all other outside mechanical influences thanks to its corrugated tape armouring. Thanks to use of stranded conductors, this cable can be moved occasionally and satisfies the usual American requirements for such networks.

### Part no.

**801192**, Foundation Fieldbus FF A

Dimensions and specifications may be changed without prior notice.

# BUS Cables

FOUNDATION™ Fieldbus flexible Type A

**HELUKABEL®**

PVC



## Type

### Cable structure

Inner conductor diameter:  
Core insulation:  
Core colours:  
Stranding element:  
Separator:  
Shielding 1:  
Total shielding:  
Drain wire:  
Outer sheath material:  
Cable external diameter:  
Outer sheath colour:

## process automation

### 1x2x1.1/2, 85-100 LI

Copper, bare (AWG 18/37)  
XLPE ray cross-linking  
bu, bn  
Double core  
-  
Al-Foil  
Cu braid, tinned  
yes  
PVC  
app. 7,9 mm ± 0,3 mm  
Yellow

## Electrical data

Characteristic impedance: 100 Ohm ± 20 Ohm  
Conductor resistance, max.: 24 Ohm/km  
Insulation resistance, min.: 2 GOhm x km  
Loop resistance: 48 Ohm/km max.  
Mutual capacitance: 65 nF/km nom.  
Nominal voltage: 300 V  
Test voltage: 1,5 kV  
Attenuation: 39 kHz ≤ 3,4 dB/km

## Technical data

Weight: app. 89 kg/km  
bending radius, repeated: 80 mm  
Operating temperature range min.: -40°C  
Operating temperature range max.: +105°C  
Caloric load, approx. value: 1,05 MJ/m  
Copper weight: 42,00 kg/km

## Norms

Applicable standards: Foundation Fieldbus Spec. FF-816-1.4  
Flame-retardant acc. to IEC 60332-3  
UL Style: CMG 105° or CL3 FT4  
CSA standard: CSA FT 4

## Application

HELUKABEL® FOUNDATION™ Fieldbus Type A for normal requirements in this industrial network. Thanks to use of stranded conductors, this cable can be moved occasionally and satisfies the usual American requirements for such networks.

## Part no.

**801193**, Foundation Fieldbus FF A

Dimensions and specifications may be changed without prior notice.

# BUS Cables

HMCB200 fixed installed

 **HELUKABEL®**

PVC

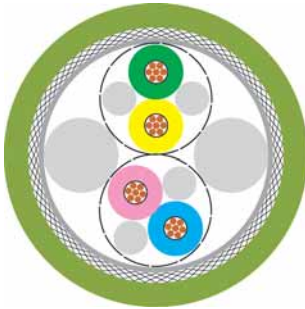

## Type

### Cable structure

Inner conductor diameter:  
Core insulation:  
Core colours:  
Stranding element:  
Separator:  
Shielding 1:  
Total shielding:  
Outer sheath material:  
Cable external diameter:  
Outer sheath colour:

## Fixed installation, indoor

### 2x2x0,22qmm

Copper, bare (AWG 22/7)  
Foam-skin-PE  
gn, ye, pk, bu  
Double core  
Polyester foil over stranded bundle  
Al-Foil  
Cu braid, tinned  
PVC  
app. 6,8 mm ± 0,15 mm  
Green similar to RAL 6018

## Electrical data

Characteristic impedance: 100 Ohm ± 15 Ohm at 1 to 100 MHz  
Conductor resistance, max.: 94,2 Ohm/km  
Insulation resistance, min.: 1 GOhm x km  
Loop resistance: 188 Ohm/km max.  
Mutual capacitance: 50 nF/km nom.  
Test voltage: 0,5 kV

## Typical values

Frequency (MHz)	10	16	62,5	100
Attenuation (dB/100m)	8,0	10,0	20,0	27,0
Next (dB)	56,0	53,0	43,0	40,0
ACR (dB)	48,0	43,0	23,0	13,0

## Technical data

Weight: app. 63 kg/km  
bending radius, repeated: 70 mm  
Operating temperature range min.: -20°C  
Operating temperature range max.: +80°C  
Caloric load, approx. value: 0,92 MJ/m  
Copper weight: 35,00 kg/km

## Norms

Applicable standards: Flame-retardant acc. to IEC 60332-1-2  
UL Style: AWM Style 2502 AWM I/II A/B 80°C 30V FT1

## Application

HELUKABEL® HMCB200 for fixed installation and slight occasional movement, range up to 100m. This cable is used in Siemens Systems. Typical plugs are RJ45 Industrial IP20 Siemens or Y-Con RJ45 Yamaichi or round M-Connectors from Molex.

## Part no.

**802471**, HMCB200

Dimensions and specifications may be changed without prior notice.

\* Drive Cliq is registered trademark from Siemens AG.



# BUS Cables

## HMCB500S Drag Chain



Drag Chain

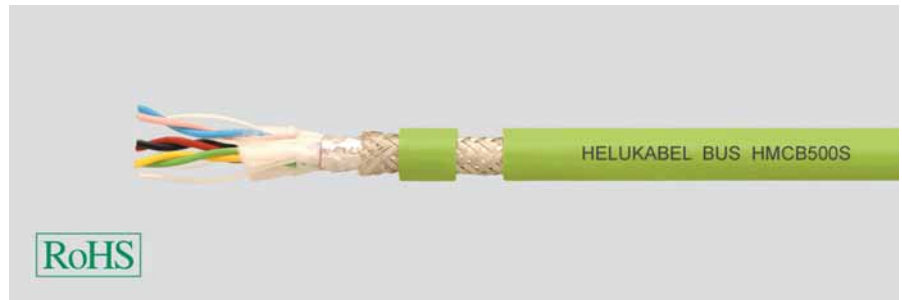

### Type

#### Cable structure

Inner conductor diameter 1:  
Inner conductor diameter 2:  
Core insulation 1:  
Core insulation 2:  
Core colours 1:  
Core colours 2:  
Stranding element 1:  
Separator:  
Shielding 1:  
Total shielding:  
Outer sheath material:  
Cable external diameter:  
Outer sheath colour:

### Drag Chain applications

#### 2x2xAWG24 + 1x2xAWG22

Copper, bare (AWG 24/7)  
Copper, tinned (AWG 22/19)  
Foam-skin-PE  
PE  
gn, ye, pk, bu  
rd, bk  
Double core  
-  
-  
AL-Foil + braid  
PVC  
app. 6,95 mm ± 0,15 mm  
Green similar to RAL 6018

### Electrical data

Characteristic impedance:  
Conductor resistance, max.:  
Insulation resistance, min.:  
Loop resistance:  
Mutual capacitance:  
Test voltage:

100 Ohm ± 15 Ohm at 1 to 100 MHz  
90 Ohm/km  
1 GOhm x km  
180 Ohm/km max.  
50 nF/km nom.  
0,5 kV

### Typical values

Frequency (MHz)	10	16	62,5	100
Attenuation (dB/100m)	10,0	12,0	23,0	30,0
Next (dB)	47,0	44,0	35,0	32,0
ACR (dB)	37,0	36,0	12,0	2,0

### Technical data

Weight: app. 66 kg/km  
bending radius, repeated: 125 mm  
Operating temperature range min.: 0°C  
Operating temperature range max.: +60°C  
Caloric load, approx. value: 0,00 MJ/m  
Copper weight: 38,00 kg/km

### Norms

Applicable standards: Flame-retardant acc. to IEC 60332-1-2  
UL Style: AWM Style 2502 AWM I/II A/B 80°C 30V FT1  
CSA standard: CSA FT1

### Application

HELUKABEL® HMCB500S is designed for occasional moving in cable carriers and ranges up to 100m without repeater. This cable is used in Siemens Systems.

Typical plugs are RJ45 Industrial IP20 Siemens or Y-Con RJ45 Yamaichi or round M-Connectors from Molex.

### Part no.

**803672**, HMCB500S

Dimensions and specifications may be changed without prior notice.

\* Drive Cliq is registered trademark from Siemens AG.

# BUS Cables

## HMCB800 Drag Chain



PUR



### Type

#### Cable structure

Inner conductor diameter 1:  
Inner conductor diameter 2:  
Core insulation 1:  
Core insulation 2:  
Core colours 1:  
Core colours 2:  
Stranding element 1:  
Separator:  
Shielding 1:  
Total shielding:  
Outer sheath material:  
Cable external diameter:  
Outer sheath colour:

### Drag Chain applications

#### 2x2x0,20qmm + 1x2x0,38qmm

Copper, bare (AWG 25/19)  
Copper, tinned (AWG 22/19)  
PE  
PE  
gn, ye, pk, bu  
rd, bk  
Double core  
-  
-  
AL-Foil + braid  
PUR  
app. 6,95 mm ± 0,15 mm  
Green similar to RAL 6018

### Electrical data

Characteristic impedance: 100 Ohm ± 15 Ohm at 1 to 100 MHz  
Conductor resistance, max.: 100 Ohm/km  
Insulation resistance, min.: 1 GOhm x km  
Loop resistance: 270 Ohm/km max.  
Mutual capacitance: 50 nF/km nom.  
Test voltage: 0,5 kV

### Typical values

Frequency (MHz)	10	16	62,5	100
Attenuation (dB/100m)	8,0	10,0	20,0	27,0
Next (dB)	47,0	44,0	35,0	32,0
ACR (dB)	39,0	34,0	15,0	5,0

### Technical data

Weight: app. 61 kg/km  
bending radius, repeated: 75 mm  
Operating temperature range min.: -20°C  
Operating temperature range max.: +60°C  
Caloric load, approx. value: 0,90 MJ/m  
Copper weight: 40,00 kg/km

### Norms

Applicable standards: Halogen-free acc. to 60754-2  
Flame-retardant acc. to IEC 60332-1-2  
UL Style: AWM Style 20236 AWM I/II A/B 80°C 30V FT1  
CSA standard: CSA FT1

### Application

HELUKABEL® HMCB800W is designed for the most demanding continuous moving requirements in cable carriers and ranges up to 70 m without repeater. This cable is ideal solution in Siemens systems.  
Typical plugs are RJ45 Industrial IP20 Siemens or Y-Con RJ45 Yamaichi or round M-Connectors from Molex.

### Part no.

**804767**, HMCB800

Dimensions and specifications may be changed without prior notice.

\* Drive Cliq is registered trademark from Siemens AG.

# BUS Cables

## USB Bus S 2.0 Drag Chain

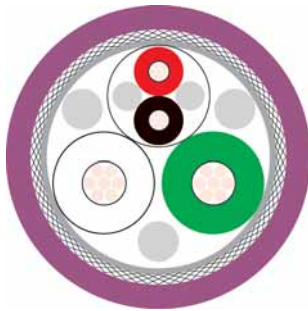

### Type

#### Cable structure

Inner conductor diameter 1:  
Inner conductor diameter 2:  
Core insulation 1:  
Core insulation 2:  
Core colours 1:  
Core colours 2:  
Stranding element 1:  
Separator:  
Shielding 1:  
Total shielding:  
Outer sheath material:  
Cable external diameter:  
Outer sheath colour:

### Drag Chain applications

#### 1x2xAWG28 + 1x2xAWG20

Copper, tinned (AWG 28/19)  
Copper, tinned (AWG 20/64)  
PP  
PP  
wh, gn  
rd, bk  
2 cores + 2 fillers stranded together  
Polyester foil over stranded bundle  
-  
AL-Foil + braid  
PUR  
app. 5,0 mm ± 0,2 mm  
Violet similar to RAL 4001

### Electrical data

Characteristic impedance: 90 Ohm ± 15 %  
Conductor resistance, max.: 230 Ohm/km  
Insulation resistance, min.: 0,1 GOhm x km  
Loop resistance: 460 Ohm/km max.  
Mutual capacitance: 60 nF/km nom.  
Test voltage: 0,5 kV

### Typical values

Frequency (MHz)	1	10	16	62,5	100	200	300	400
Attenuation (dB/100m)	4,5	12,0	15,4	31,0	39,0	60,0	76,2	99,0

### Technical data

Weight: app. 45 kg/km  
bending radius, repeated: 50 mm  
Operating temperature range min.: -30°C  
Operating temperature range max.: +60°C  
Caloric load, approx. value: 0,55 MJ/m  
Copper weight: 30,00 kg/km

### Norms

Applicable standards: USB-Standard 2.0  
Halogen-free acc. to 60754-2  
Flame-retardant CSA FT1  
UL Style: AWM 20963 (80°C/30V)  
CSA standard: CSA FT1

### Application

HELUKABEL® USB BUS S is designed for continuous moving in cable carriers and lengths up to max. 5m. Conventional USB cables fail within a short period of time, which is why HELUKABEL developed this special cable. Thanks to the PUR sheath, it also offers excellent resistance to common mineral oils, greases and cooling lubricants.

### Part no.

**802469**, USB S

Dimensions and specifications may be changed without prior notice.

# BUS Cables

## USB Bus L 2.0 Drag Chain



PUR

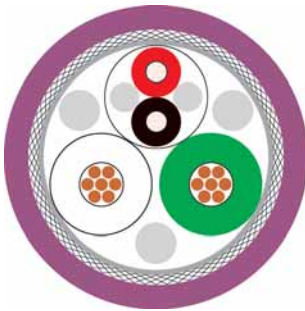

### Type

#### Cable structure

Inner conductor diameter 1:  
Inner conductor diameter 2:  
Core insulation 1:  
Core insulation 2:  
Core colours 1:  
Core colours 2:  
Stranding element 1:  
Separator:  
Shielding 1:  
Total shielding:  
Drain wire:  
Outer sheath material:  
Cable external diameter:  
Outer sheath colour:

### Drag Chain applications

#### 1x2xAWG24 + 1x2xAWG20

Copper, tinned (AWG 24/19)  
Copper, tinned (AWG 20/19)  
PO  
PVC  
wh, gn  
rd, bk  
Double core  
-  
-  
AL-Foil + braid  
yes  
PUR  
app. 6,3 mm ± 0,2 mm  
Violet similar to RAL 4001

### Electrical data

Characteristic impedance: 90 Ohm ± 15 %  
Conductor resistance, max.: 36 Ohm/km  
Insulation resistance, min.: 0,2 GOhm x km  
Loop resistance: 71 Ohm/km max.  
Mutual capacitance: 50 nF/km nom.  
Nominal voltage: 300 V  
Test voltage: 2 kV

### Typical values

Frequency (MHz)	1	24	48	96	200	400
Attenuation (dB/100m)	4,0	19,0	27,0	38,0	64,0	116,0

### Technical data

Weight: app. 56 kg/km  
bending radius, repeated: 95 mm  
Operating temperature range min.: -30°C  
Operating temperature range max.: +70°C  
Caloric load, approx. value: 0,57 MJ/m  
Copper weight: 40,00 kg/km

### Norms

Applicable standards: USB-Standard 2.0  
Flame-retardant acc. to IEC 60332-1-2  
UL Style: AWM 21198 (80°C/ 300V)

### Application

HELUKABEL® USB BUS L is designed for continuous motion in cable carriers and lengths up to max. 10m without a repeater. Conventional USB cables fail within a short period of time and need a repeater after a cable length of 5m, which is why HELUKABEL developed this special cable with a larger cross-section. Thanks to the PUR sheath, it also offers excellent resistance to common mineral oils, greases and cooling lubricants.

### Part no.

802470, USB L

Dimensions and specifications may be changed without prior notice.

# BUS Cables

## USB Bus 3.0 Drag Chain



PUR



### Type

#### Cable structure

Inner conductor diameter 1:  
Inner conductor diameter 2:  
Core insulation 1:  
Core insulation 2:  
Core colours 1:  
Core colours 2:  
Stranding element 1:  
Separator:  
Shielding 1:  
Total shielding:  
Outer sheath material:  
Cable external diameter:  
Outer sheath colour:

### Drag Chain applications

#### 2x2xAWG28 + 2x(1x2xAWG28)

Copper, tinned (AWG 28/19)  
Copper, tinned (AWG 28/19)  
Foam-skin-PE  
PE  
bu/ye, or/vio  
rd/bk, gn/gnwh  
Double core  
Polyester foil over stranded bundle  
AL-Foil + braid  
Cu braid, tinned  
PUR  
app. 6,5 mm ± 0,3 mm  
Violet similar to RAL 4001

### Electrical data

Characteristic impedance: 90 Ohm ± 20 %  
105 Ohm ± 15% at 1 MHz  
Conductor resistance, max.: 205 Ohm/km  
Insulation resistance, min.: 2 GOhm x km  
Loop resistance: 410 Ohm/km max.  
Mutual capacitance: 60 nF/km nom.  
Test voltage: 0,7 kV  
Relative propagation velocity: 75 %

### Typical values

Frequency (MHz)	1	625	1200
Attenuation UTP pair (dB/100m)	4,0	-	-
Attenuation S/FTP pair (dB/100m)	4,0	115,0	180,0

### Technical data

Weight: app. 62 kg/km  
bending radius, repeated: 55 mm  
Operating temperature range min.: -30°C  
Operating temperature range max.: +70°C  
Caloric load, approx. value: 0,69 MJ/m  
Copper weight: 42,00 kg/km

### Norms

Applicable standards: USB-Standard 3.0  
Halogen-free acc. to 60754-2  
Flame-retardant acc. to IEC 60332-1-2  
AWM Style 20236 AWM I/II A/B 80°C 30V FT1  
CSA FT1  
UL Style:  
CSA standard:

### Application

HELUKABEL® USB S 3.0, designed specifically for use in heavy-duty industries, are the ideal solution for highly-flexible applications such as Drag Chains and camera technology. They guarantee superior transmission properties. The transmission distance is connected with the transmission rate.

### Part no.

**805287**, USB S

Dimensions and specifications may be changed without prior notice.

# BUS Cables

## FIREWIRE Drag Chain



PUR

NEW



### Type

#### Cable structure

Inner conductor diameter 1:  
Inner conductor diameter 2:  
Core insulation 1:  
Core insulation 2:  
Total shielding:  
Outer sheath material:  
Cable external diameter:  
Outer sheath colour:

### Drag Chain applications

#### 2x2xAWG26/19 + 2xAWG22/19

Copper, tinned (AWG 22/19)  
Copper, tinned (AWG 26/19)  
PP  
Foam-skin-PE  
Cu braid, tinned  
PUR  
app. 8,2 mm  
Violet similar to RAL 4001

### Electrical data

Characteristic impedance:  
Conductor resistance, max.:  
Insulation resistance, min.:  
Loop resistance:  
Mutual capacitance:  
Nominal voltage:  
Test voltage:

100 Ohm  $\pm$  15 %  
59,4 Ohm/km  
2 GOhm x km  
120 Ohm/km max.  
45 nF/km nom.  
30 V  
0,7 kV

### Typical values

Frequency (MHz)	250	400	500	800	1000
attenuation (dB/5m)	2,5	3,0	3,6	4,7	5,6

### Technical data

Weight:  
bending radius, repeated:  
Operating temperature range min.:  
Operating temperature range max.:  
Caloric load, approx. value:  
Copper weight:

app. 88 kg/km  
98 mm  
-30°C  
+70°C  
0,986 MJ/m  
58,00 kg/km

### Norms

Applicable standards:  
UL Style:

Halogen-free acc. to 60754-2  
Flame-retardant CSA FT1  
AWM Style 20236 AWM I/II A/B 80°C 30V FT1

### Application

HELUKABEL® FireWire™ Trailing will be used for permanent moving processes.

### Part no.

**805057**, FireWire™

Dimensions and specifications may be changed without prior notice.

# BUS Cables

Coax 50 Ohm, Drag Chain

**HELUKABEL®**

PUR

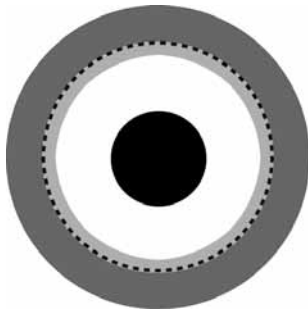

## Cable structure

Inner conductor material: copper, bare  
Inner conductor diameter: 0,9 mm  
Outer conductor material: copper, tinned  
Outer conductor form: Braiding  
Dielectric: PP  
Total shielding: Cu braid, tinned  
Sheath material: PUR (Polyurethan)  
External diameter: app. 5,4 mm ± 0,2 mm  
Sheath colour: black

## 19x0,18/ 2,95mm 50 Ohm

## Electrical data

Characteristic impedance: 50 Ohm ± 2 Ohm  
Conductor resistance, max.: 38 Ohm/km  
Insulation resistance, min.: 1 GOhm x km  
Test voltage: 2 kV  
Relative propagation velocity: 67 %

## Typical values

Frequency (MHz)	50	100	200	300	500	800	900	1000	1800	2000
Attenuation (dB/100m)	11,5	16,5	24,0	30,0	40,0	52,0	59,0	65,0	105,0	112,0

## Technical data

Weight: app. 45 kg/km  
bending radius, repeated: 54 mm  
Operating temperature range max.: +50°C  
Laying temperature range min.: -20°C  
Laying temperature range max.: +50°C  
Copper weight: 23,00 kg/km

## Norms

Applicable standards: Halogen-free acc. to 60754-2

## Application

This Coax cable, designed specifically for use in heavy-duty industries, is the ideal solution for highly-flexible applications such as Drag Chains.

## Part no.

**804299**, Coax Drag Chain

Dimensions and specifications may be changed without prior notice.

# BUS Cables

CAN Bus fixed installed

 **HELUKABEL®**

PVC

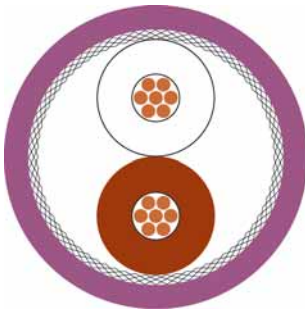

## Type

### Cable structure

Inner conductor diameter:  
Core insulation:  
Core colours:  
Stranding element:  
Separator:  
Shielding 1:  
Total shielding:  
Outer sheath material:  
Cable external diameter:  
Outer sheath colour:

### Fixed installation, indoor 1x2x0.22 mm<sup>2</sup> (stranded)

Copper, bare (AWG 24/7)  
Cell PE  
wh/bn  
Double core  
Polyester foil over stranded bundle  
-  
Cu braid, tinned  
PVC  
app. 5,4 mm ± 0,2 mm  
Violet similar to RAL 4001

### Fixed installation, indoor 4x1x0.22 mm<sup>2</sup> (stranded)

Copper, bare (AWG 24/7)  
Cell PE  
wh, bn, gn, ye  
Star quad  
Polyester foil over stranded bundle  
-  
Cu braid, tinned  
PVC  
app. 6,9 mm ± 0,2 mm  
Violet similar to RAL 4001

## Electrical data

Characteristic impedance:  
Conductor resistance, max.:  
Insulation resistance, min.:  
Loop resistance:  
Mutual capacitance:  
Nominal voltage:  
Test voltage:

120 Ohm ± 10 %  
88 Ohm/km  
1 GOhm x km  
175 Ohm/km max.  
58 nF/km nom.  
30 V  
1,5 kV

120 Ohm ± 10 %  
88 Ohm/km  
1 GOhm x km  
175 Ohm/km max.  
58 nF/km nom.  
30 V  
1,5 kV

## Technical data

Weight:  
bending radius, repeated:  
Operating temperature range min.:  
Operating temperature range max.:  
Caloric load, approx. value:  
Copper weight:

app. 41 kg/km  
81 mm  
-40°C  
+70°C  
0,574 MJ/m  
17,00 kg/km

app. 60 kg/km  
107 mm  
-40°C  
+70°C  
1,234 MJ/m  
21,00 kg/km

## Norms

Applicable standards:  
UL Style:

CAN Bus acc. to ISO 11898-2  
Flame-retardant acc. to EN 50265-2-1  
UL Style 2571

CAN Bus acc. to ISO 11898-2  
Flame-retardant acc. to EN 50265-2-1  
UL Style 2571

## Application

HELUKABEL® CAN Bus for fixed installation and occasional motion, for normal requirements. The 2-pair version is designed with star-quad twisting, i.e. diagonal conductors form an electrical pair and meets the requirements of the CAN Standard. For cable lengths up to max. 40m (observe CAN specifications).

## Part no.

**81286**, CAN BUS

**81287**, CAN BUS

Dimensions and specifications may be changed without prior notice.



# BUS Cables

CAN Bus fixed installed

**HELUKABEL®**

PVC

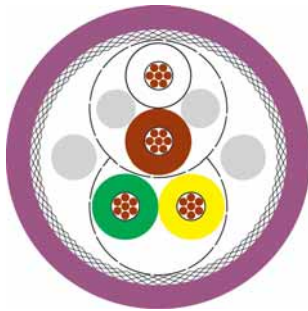

## Type

### Cable structure

Inner conductor diameter:  
Core insulation:  
Core colours:  
Stranding element:  
Separator:  
Shielding 1:  
Total shielding:  
Outer sheath material:  
Cable external diameter:  
Outer sheath colour:

## Fixed installation, indoor 2x2x0.22 mm<sup>2</sup> (stranded)

Copper, bare (AWG 24/7)  
Cell PE  
wh/bn, gn/ye  
2 cores + 2 fillers stranded together  
Polyester foil over stranded bundle  
-  
Cu braid, tinned  
PVC  
app. 7,5 mm ± 0,3 mm  
Violet similar to RAL 4001

## Electrical data

Characteristic impedance: 120 Ohm ± 10 %  
Conductor resistance, max.: 87,6 Ohm/km  
Insulation resistance, min.: 5 GOhm x km  
Loop resistance: 175 Ohm/km max.  
Mutual capacitance: 40 nF/km nom.  
Nominal voltage: 30 V  
Test voltage: 1,5 kV

## Technical data

Weight: app. 60 kg/km  
bending radius, repeated: 113 mm  
Operating temperature range min.: -25°C  
Operating temperature range max.: +70°C  
Caloric load, approx. value: 1,13 MJ/m  
Copper weight: 32,00 kg/km

## Norms

Applicable standards: CAN Bus acc. to ISO 11898-2  
Flame-retardant acc. to IEC 60332-1-2  
UL Style: UL Style 2571  
CSA standard: CSA FT1

## Application

HELUKABEL® CAN BUS for fixed installation and occasion motion, for normal requirements. The two signal pairs are provided in the form twisted pairs. As a result, the diameter is somewhat larger than that of 81287. In the event of diameter problems, please have a look at this type. For cable lengths up to max. 40m ( observe CAN specifications).

## Part no.

**82509**, CAN BUS

Dimensions and specifications may be changed without prior notice.

# BUS Cables

CAN Bus fixed installed 105°C

**HELUKABEL®**

PVC

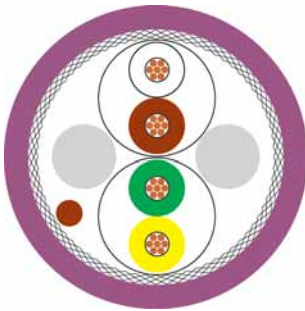

## Type

### Cable structure

Inner conductor diameter:  
Core insulation:  
Core colours:  
Stranding element:  
Separator:  
Shielding 1:  
Total shielding:  
Outer sheath material:  
Cable external diameter:  
Outer sheath colour:

## Industrial Area

### 2x2xAWG 24/ 19 mm<sup>2</sup> (stranded)

Copper, bare (AWG 24/19)  
XLPE ray cross-linking  
wh/bn, gn/ye  
Double core  
Polyester foil over stranded bundle  
-  
Cu braid, tinned  
PUR  
app. 8,4 mm ± 0,3 mm  
Violet similar to RAL 4001

## Electrical data

Characteristic impedance: 120 Ohm ± 10 %  
Conductor resistance, max.: 87,2 Ohm/km  
Insulation resistance, min.: 1 GOhm x km  
Loop resistance: 174 Ohm/km max.  
Mutual capacitance: 42 nF/km nom.  
Nominal voltage: 600 V  
Test voltage: 2,5 kV

## Technical data

Weight: app. 80 kg/km  
bending radius, repeated: 126 mm  
Operating temperature range min.: -40°C  
Operating temperature range max.: +105°C \*  
Caloric load, approx. value: 1,31 MJ/m  
Copper weight: 40,00 kg/km

## Norms

Applicable standards: CAN Bus acc. to ISO 11898-2  
Halogen-free acc. to 60754-2  
Flame-retardant acc. to IEC 60332-1-2  
UL/CSA 21223 80°C, 600V  
UL Style:

## Application

HELUKABEL® CAN Bus for fixed installation up to 105°C in difficult industrial environments with demanding temperature requirements thanks to cross-linking of the conductor insulation. Thanks to use a PUR sheath, this version is also halogen-free. For cable lengths up to max. 40m (observe CAN specifications).

## Part no.

**801982**, CAN BUS

Dimensions and specifications may be changed without prior notice.

# BUS Cables

CAN Bus fixed installed

**HELUKABEL®**

PVC

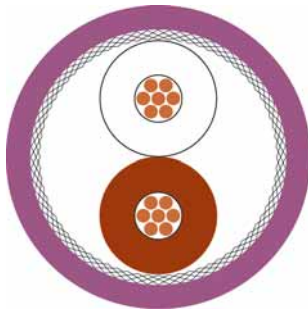

## Type Cable structure

Inner conductor diameter:  
Core insulation:  
Core colours:  
Stranding element:  
Separator:  
Shielding 1:  
Total shielding:  
Outer sheath material:  
Cable external diameter:  
Outer sheath colour:

## Fixed installation, indoor 1x2x0.34 mm<sup>2</sup> (stranded)

Copper, bare (AWG 22/7)  
Cell PE  
wh/bn  
Double core  
Polyester foil over stranded bundle  
-  
Cu braid, tinned  
PVC  
app. 6,5 mm ± 0,2 mm  
Violet similar to RAL 4001

## Fixed installation, indoor 4x1x0.34 mm<sup>2</sup> (stranded)

Copper, bare (AWG 22/7)  
Cell PE  
wh/bn, gn/ye  
Star quad  
Polyester foil over stranded bundle  
-  
Cu braid, tinned  
PVC  
app. 8,0 mm ± 0,2 mm  
Violet similar to RAL 4001

## Electrical data

Characteristic impedance:  
Conductor resistance, max.:  
Insulation resistance, min.:  
Loop resistance:  
Mutual capacitance:  
Nominal voltage:  
Test voltage:

120 Ohm ± 10 %  
57 Ohm/km  
5 GOhm x km  
114 Ohm/km max.  
58 nF/km nom.  
30 V  
2 kV

120 Ohm ± 10 %  
57 Ohm/km  
5 GOhm x km  
114 Ohm/km max.  
40 nF/km nom.  
30 V  
2 kV

## Technical data

Weight:  
bending radius, repeated:  
Operating temperature range min.:  
Operating temperature range max.:  
Caloric load, approx. value:  
Copper weight:

app. 65 kg/km  
98 mm  
-30°C  
+70°C  
1,109 MJ/m  
23,00 kg/km

app. 77 kg/km  
120 mm  
-30°C  
+70°C  
1,179 MJ/m  
30,00 kg/km

## Norms

Applicable standards:  
UL Style:

CAN Bus acc. to ISO 11898-2  
Flame-retardant acc. to EN 50265-2-1  
UL Style 2571

CAN Bus acc. to ISO 11898-2  
Flame-retardant acc. to EN 50265-2-1  
UL Style 2571

## Application

HELUKABEL® CAN Bus for fixed installation and occasional motion, for normal requirements. The 2-pair version is designed with a star-quad twisting, i.e. diagonal conductors form an electrical pair and meets the requirements of the CAN standard. For cable lengths up to max. 40m (observe CAN specifications).

## Part no.

**801572**, CAN BUS

**801573**, CAN BUS

Dimensions and specifications may be changed without prior notice.

# BUS Cables

CAN Bus fixed installed

 **HELUKABEL®**

PVC

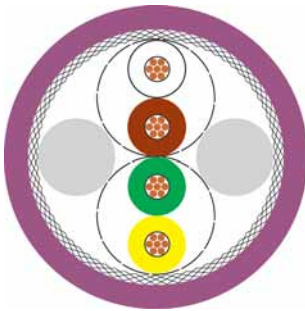

## Type

### Cable structure

Inner conductor Ø:	Copper, bare (AWG 22/7)
Core insulation:	Foam-skin-PE
Core colours:	wh/bn, gn/ye
Stranding element:	Double core
Separator:	Polyester foil over stranded bundle
Shielding 1:	-
Total shielding:	Cu braid, tinned
Outer sheath material:	PVC
Cable external diameter:	app. 8,5 mm ± 0,3 mm
Outer sheath colour:	Violet similar to RAL 4001

### Electrical data

Characteristic impedance:	120 Ohm ± 10 %
Conductor resistance, max.:	55,4 Ohm/km
Insulation resistance, min.:	5 GOhm x km
Loop resistance:	110 Ohm/km max.
Mutual capacitance:	40 nF/km nom.
Nominal voltage:	250 V
Test voltage:	1,5 kV

### Technical data

Weight:	app. 85 kg/km
bending radius, repeated:	130 mm
Operating temperature range min.:	-40°C
Operating temperature range max.:	+70°C
Caloric load, approx. value:	1,32 MJ/m
Copper weight:	46,00 kg/km

### Norms

Applicable standards:	CAN Bus acc. to ISO 11898-2 Flame-retardant acc. to IEC 60332-1-2
UL Style:	CMX 75°C (shielded)
CSA standard:	CSA FT1

### Application

HELUKABEL® CAN Bus fixed installations and occasionally motion, for normal requirements. The two signal pairs are provided in the form twisted pairs. As a result, the diameter is somewhat larger than that of 801573. In the event of diameter problems, please have a look at this type. For cable lengths up to max. 40m (observe CAN specifications).

### Part no.

**803344**, CAN BUS

Dimensions and specifications may be changed without prior notice.

# BUS Cables

CAN Bus fixed installed

**HELUKABEL®**

PVC

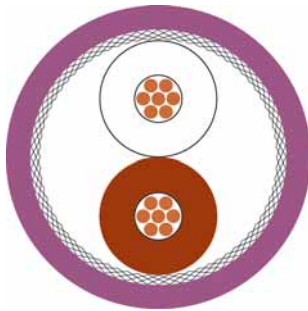

## Type Cable structure

Inner conductor diameter:  
Core insulation:  
Core colours:  
Stranding element:  
Separator:  
Shielding 1:  
Total shielding:  
Outer sheath material:  
Cable external diameter:  
Outer sheath colour:

## Fixed installation, indoor 1x2x0.50 mm<sup>2</sup> (stranded)

Copper, bare (AWG 20/7)  
Foam-skin-PE  
wh/bn  
Double core  
Polyester foil over stranded bundle  
-  
Cu braid, tinned  
PVC  
app. 7,0 mm ± 0,2 mm  
Violet similar to RAL 4001

## Fixed installation, indoor 4x1x0.50 mm<sup>2</sup> (stranded)

Copper, bare (AWG 20/7)  
Foam-skin-PE  
wh, bn, gn, ye  
Star quad  
Polyester foil over stranded bundle  
-  
Cu braid, tinned  
PVC  
app. 8,5 mm ± 0,2 mm  
Violet similar to RAL 4001

## Electrical data

Characteristic impedance:  
Conductor resistance, max.:  
Insulation resistance, min.:  
Loop resistance:  
Mutual capacitance:  
Test voltage:

120 Ohm ± 10 %  
36,4 Ohm/km  
1 GOhm x km  
72 Ohm/km max.  
40 nF/km nom.  
1,5 kV

120 Ohm ± 10 %  
37 Ohm/km  
1 GOhm x km  
74 Ohm/km max.  
44 nF/km nom.  
1,5 kV

## Technical data

Weight:  
bending radius, repeated:  
Operating temperature range min.:  
Operating temperature range max.:  
Caloric load, approx. value:  
Copper weight:

app. 69 kg/km  
100 mm  
-40°C  
+70°C  
1,09 MJ/m  
30,00 kg/km

app. 100 kg/km  
130 mm  
-40°C  
+70°C  
1,64 MJ/m  
45,00 kg/km

## Norms

Applicable standards:  
UL Style:

CAN Bus acc. to ISO 11898-2  
Flame-retardant acc. to EN 50265-2-1  
UL Style 2571

CAN Bus acc. to ISO 11898-2  
Flame-retardant acc. to EN 50265-2-1  
UL Style 2571

## Application

HELUKABEL® CAN Bus for fixed installation and occasion motion, for normal requirements. The 2-pair version is designed with star-quad twisting, i.e. diagonal conductors form an electrical pair and meets the requirements of the CAN standard. For cable lengths up to 600m (observe CAN specifications).

## Part no.

**800571**, CAN BUS

**800685**, CAN BUS

Dimensions and specifications may be changed without prior notice.

# BUS Cables

## CAN Bus fixed installed



PVC

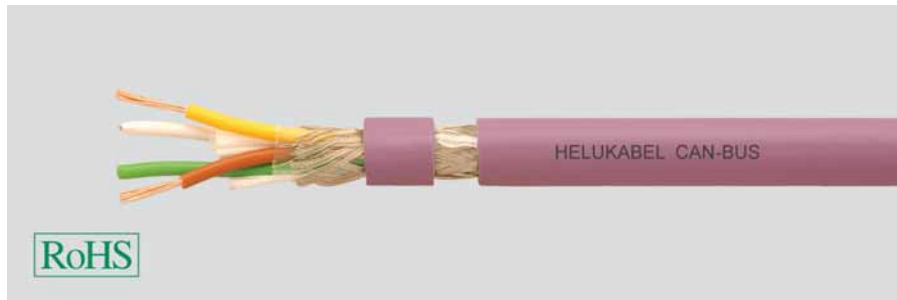
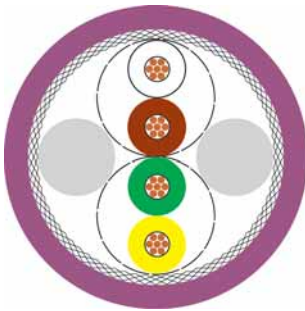

### Type

#### Cable structure

Inner conductor diameter:  
Core insulation:  
Core colours:  
Stranding element:  
Separator:  
Shielding 1:  
Total shielding:  
Outer sheath material:  
Cable external diameter:  
Outer sheath colour:

### Fixed installation, indoor 2x2x0.50 mm<sup>2</sup> (stranded)

Copper, bare (AWG 20/7)  
Foam-skin-PE  
wh/bn, gn/ye  
Double core  
Polyester foil over stranded bundle  
-  
Cu braid, tinned  
PVC  
app. 9,6 mm ± 0,3 mm  
Violet similar to RAL 4001

### Electrical data

Characteristic impedance: 120 Ohm ± 10 %  
Conductor resistance, max.: 34,4 Ohm/km  
Insulation resistance, min.: 5 GOhm x km  
Loop resistance: 68 Ohm/km max.  
Mutual capacitance: 40 nF/km nom.  
Nominal voltage: 250 V  
Test voltage: 1,5 kV

### Technical data

Weight: app. 116 kg/km  
bending radius, repeated: 150 mm  
Operating temperature range min.: -40°C  
Operating temperature range max.: +70°C  
Caloric load, approx. value: 1,62 MJ/m  
Copper weight: 60,00 kg/km

### Norms

Applicable standards: CAN Bus acc. to ISO 11898-2  
Flame-retardant acc. to IEC 60332-1-2  
UL Style: CMX 75°C (shielded)  
CSA standard: CSA FT1

### Application

HELUKABEL® CAN Bus for fixed installation and occasion motion, for normal requirements. The two signal pairs are provided in the form twisted pairs. As a result, the diameter is somewhat larger than that of 800685. In the event of diameter problems, please have a look at this type. For cable lengths up to 600m (observe CAN specifications).

### Part no.

**803722**, CAN BUS

Dimensions and specifications may be changed without prior notice.

# BUS Cables

## CAN Bus direct Burial

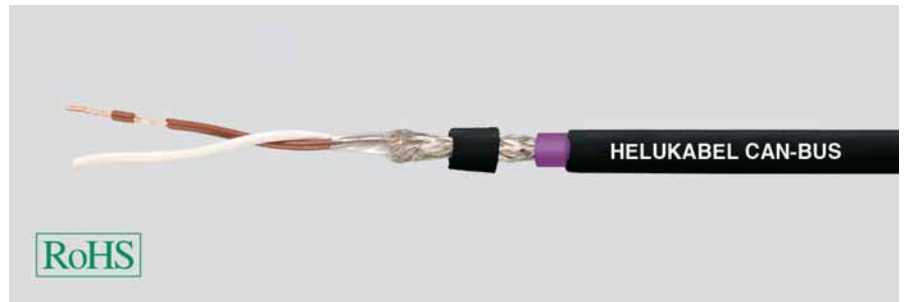
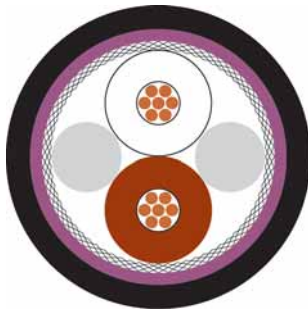

### Type Cable structure

Inner conductor diameter:  
Core insulation:  
Core colours:  
Stranding element:  
Separator:  
Inner sheath material:  
Shielding 1:  
Total shielding:  
Armouring:  
Outer sheath material:  
Cable external diameter:  
Outer sheath colour:

### Electrical data

Characteristic impedance:  
Conductor resistance, max.:  
Insulation resistance, min.:  
Loop resistance:  
Mutual capacitance:  
Test voltage:

### Technical data

Weight:  
bending radius, repeated:  
Operating temperature range min.:  
Operating temperature range max.:  
Caloric load, approx. value:  
Copper weight:

### Norms

Applicable standards:

### Application

HELUKABEL® CAN Bus Direct Burial is suitable for fixed outdoor installation or direct burial applications. The 2-pair version is designed with star-quad twisting, i.e. diagonal conductors form an electrical pair and meets the requirements of the CAN standard. For cable lengths up to 600m (observe CAN specifications).

### Part no.

Dimensions and specifications may be changed without prior notice.

### Direct burial 1x2x0.50 mm<sup>2</sup> (stranded)

Copper, bare (AWG 20/7)  
Foam-skin-PE  
wh/bn  
2 cores + 2 fillers stranded together  
Polyester foil over stranded bundle  
PVC  
-  
Cu braid, tinned  
PET/PA tape  
PE  
app. 9,2 mm ± 0,4 mm  
Black similar to RAL 9005

120 Ohm ± 10 %  
37 Ohm/km  
1 GOhm x km  
74 Ohm/km max.  
40 nF/km nom.  
1,5 kV

app. 105 kg/km  
150 mm  
-40°C  
+70°C  
2,05 MJ/m  
33,00 kg/km

CAN Bus acc. to ISO 11898-2

### Direct burial 4x1x0.50 mm<sup>2</sup> (stranded)

Copper, bare (AWG 20/7)  
Foam-skin-PE  
wh, bn, gn, ye  
Star quad  
Polyester foil over stranded bundle  
PVC  
-  
Cu braid, tinned  
PET/PA tape  
PE  
app. 9,7 mm ± 0,4 mm  
Black similar to RAL 9005

120 Ohm ± 10 %  
36,4 Ohm/km  
1 GOhm x km  
72 Ohm/km max.  
44 nF/km nom.  
1,5 kV

app. 115 kg/km  
160 mm  
-40°C  
+70°C  
2,18 MJ/m  
45,00 kg/km

CAN Bus acc. to ISO 11898-2

# BUS Cables

CAN Bus fixed installed

 **HELUKABEL®**

PVC

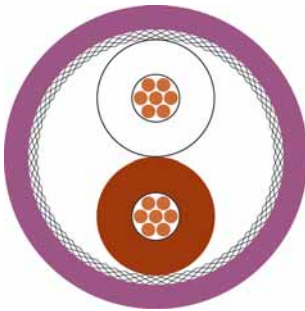

## Type

### Cable structure

Inner conductor diameter:  
Core insulation:  
Core colours:  
Stranding element:  
Separator:  
Shielding 1:  
Total shielding:  
Outer sheath material:  
Cable external diameter:  
Outer sheath colour:

### Fixed installation, indoor 1x2x0.75 mm<sup>2</sup> (stranded)

Copper, bare (AWG 18/24)  
Foam-skin-PE  
wh/bn  
Double core  
Polyester foil over stranded bundle  
-  
Cu braid, tinned  
PVC  
app. 8,3 mm ± 0,3 mm  
Violet similar to RAL 4001

### Fixed installation, indoor 4x1x0.75 mm<sup>2</sup> (stranded)

Copper, bare (AWG 18/24)  
Foam-skin-PE  
wh, bn, gn, ye  
Star quad  
Polyester foil over stranded bundle  
-  
Cu braid, tinned  
PVC  
app. 8,8 mm ± 0,3 mm  
Violet similar to RAL 4001

## Electrical data

Characteristic impedance:  
Conductor resistance, max.:  
Insulation resistance, min.:  
Loop resistance:  
Mutual capacitance:  
Nominal voltage:  
Test voltage:

120 Ohm ± 15 %  
27,5 Ohm/km  
1 GOhm x km  
55 Ohm/km max.  
42 nF/km nom.  
300 V  
1,5 kV

120 Ohm ± 15 %  
27,5 Ohm/km  
1 GOhm x km  
55 Ohm/km max.  
42 nF/km nom.  
300 V  
1,5 kV

## Technical data

Weight:  
bending radius, repeated:  
Operating temperature range min.:  
Operating temperature range max.:  
Caloric load, approx. value:  
Copper weight:

app. 101 kg/km  
110 mm  
-40°C  
+70°C  
1,67 MJ/m  
40,00 kg/km

app. 112 kg/km  
110 mm  
-40°C  
+70°C  
1,76 MJ/m  
58,00 kg/km

## Norms

Applicable standards:  
UL Style:  
CSA standard:

CAN Bus acc. to ISO 11898-2  
Flame-retardant acc. to IEC 60332-1-2  
UL Style 2571  
CSA FT1

CAN Bus acc. to ISO 11898-2  
Flame-retardant acc. to IEC 60332-1-2  
UL Style 2571  
CSA FT1

## Application

HELUKABEL® CAN Bus for fixed installation and occasion motion, for normal requirements. The 2-pair version is designed with star-quad twisting, i.e. diagonal conductors form an electrical pair and satisfy the requirements of the CAN standard. For cable lengths over 600m (observe CAN specifications).

## Part no.

**803383**, CAN BUS

**803384**, CAN BUS

Dimensions and specifications may be changed without prior notice.



# BUS Cables

## CAN Bus Drag Chain



PUR

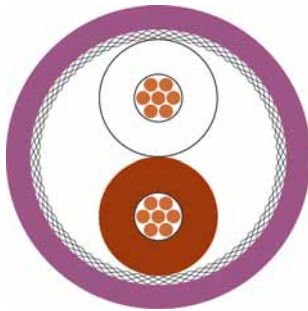

### Type Cable structure

Inner conductor diameter:  
Core insulation:  
Core colours:  
Stranding element:  
Separator:  
Shielding 1:  
Total shielding:  
Outer sheath material:  
Cable external diameter:  
Outer sheath colour:

### Drag Chain applications 1x2x0.25 mm<sup>2</sup> (stranded)

Copper, bare (AWG 24/19)  
PE  
wh/bn  
Double core  
Polyester foil over stranded bundle  
-  
Cu braid, tinned  
PUR  
app. 6,1 mm ± 0,3 mm  
Violet similar to RAL 4001

### Drag Chain applications 4x1x0.25 mm<sup>2</sup> (stranded)

Copper, bare (AWG 24/19)  
PE  
wh, bn, gn, ye  
Star quad  
Polyester foil over stranded bundle  
-  
Cu braid, tinned  
PUR  
app. 6,5 mm ± 0,3 mm  
Violet similar to RAL 4001

### Electrical data

Characteristic impedance:  
Conductor resistance, max.:  
Insulation resistance, min.:  
Loop resistance:  
Mutual capacitance:  
Test voltage:

120 Ohm ± 10 %  
87,6 Ohm/km  
1 GOhm x km  
175 Ohm/km max.  
50 nF/km nom.  
1,5 kV

120 Ohm ± 10 %  
85 Ohm/km  
1 GOhm x km  
170 Ohm/km max.  
50 nF/km nom.  
1,5 kV

### Technical data

Weight:  
bending radius, repeated:  
Operating temperature range min.:  
Operating temperature range max.:  
Caloric load, approx. value:  
Copper weight:

app. 40 kg/km  
90 mm  
-40°C  
+70°C  
0,798 MJ/m  
18,00 kg/km

app. 45 kg/km  
95 mm  
-30°C  
+70°C  
0,943 MJ/m  
25,00 kg/km

### Norms

Applicable standards:

CAN Bus acc. to ISO 11898-2  
Halogen-free acc. to 60754-2

CAN Bus acc. to ISO 11898-2  
Halogen-free acc. to 60754-2

### Application

HELUKABEL® CAN Bus is designed for guided continuous motion in cable carriers. The 2-pair version is designed with a star-quad twisting, i.e. diagonal conductors form an electrical pair and satisfy the requirements of the CAN standard. For cable lengths up to max. 40m (observe CAN specifications).

### Part no.

**81911**, CAN BUS, highly flexible

**81912**, CAN BUS, highly flexible

Dimensions and specifications may be changed without prior notice.

# BUS Cables

CAN Bus Drag Chain, UL

 **HELUKABEL®**

PUR

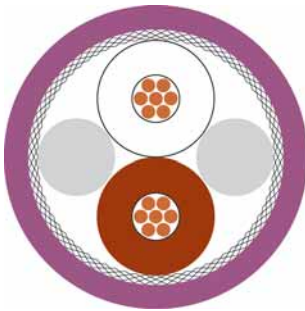

## Type

### Cable structure

Inner conductor diameter:  
Core insulation:  
Core colours:  
Stranding element:  
Separator:  
Shielding 1:  
Total shielding:  
Outer sheath material:  
Cable external diameter:  
Outer sheath colour:

### Drag Chain applications 1x2x0.34 mm<sup>2</sup> (stranded)

Copper, bare (AWG 22)  
Foam-skin-PE  
wh/bn  
2 cores + 2 fillers stranded together  
-  
-  
Cu braid, tinned  
PUR  
app. 6,9 mm ± 0,3 mm  
Violet similar to RAL 4001

### Drag Chain applications 4x1x0.34 mm<sup>2</sup> (stranded)

Copper, bare (AWG 22/43)  
Foam-skin-PE  
wh/bn, gn/ye  
Star quad  
-  
-  
Cu braid, tinned  
PUR  
app. 7,5 mm ± 0,3 mm  
Violet similar to RAL 4001

## Electrical data

Characteristic impedance:  
Conductor resistance, max.:  
Insulation resistance, min.:  
Loop resistance:  
Mutual capacitance:  
Nominal voltage:  
Test voltage:

120 Ohm ± 15 %  
56 Ohm/km  
5 GOhm x km  
170 Ohm/km max.  
40 nF/km nom.  
250 V  
1,5 kV

120 Ohm ± 15 %  
56 Ohm/km  
5 GOhm x km  
170 Ohm/km max.  
40 nF/km nom.  
250 V  
1,5 kV

## Technical data

Weight:  
bending radius, repeated:  
Operating temperature range min.:  
Operating temperature range max.:  
Caloric load, approx. value:  
Copper weight:

app. 54 kg/km  
105 mm  
-30°C  
+70°C  
1,20 MJ/m  
30,00 kg/km

app. 64 kg/km  
130 mm  
-30°C  
+70°C  
1,20 MJ/m  
42,00 kg/km

## Norms

Applicable standards:

CAN Bus acc. to ISO 11898-2  
Halogen-free acc. to 60754-2  
Flame-retardant acc. to IEC 60332-1-2  
CMX 444

CAN Bus acc. to ISO 11898-2  
Halogen-free acc. to 60754-2  
Flame-retardant acc. to IEC 60332-1-2  
CMX 444

## Application

HELUKABEL® CAN Bus is designed for guided continuous motion in cable carriers. The 2-pair version is designed with star-quad twisting, i.e. diagonal conductors form an electrical pair and meets the requirements of the CAN standard. For cable lengths up to max. 40m (observe CAN specifications).

## Part no.

**802182**, CAN BUS, highly flexible

**802339**, CAN BUS, highly flexible

Dimensions and specifications may be changed without prior notice.

# BUS Cables

CAN Bus Drag Chain, UL

**HELUKABEL®**

PUR

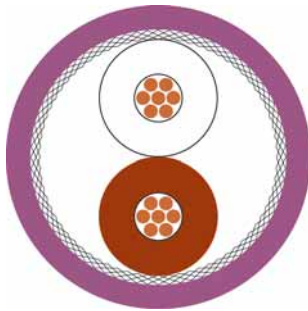

NEW

## Type Cable structure

Inner conductor diameter:  
Core insulation:  
Core colours:  
Stranding element:  
Separator:  
Shielding 1:  
Total shielding:  
Outer sheath material:  
Cable external diameter:  
Outer sheath colour:

## Drag Chain applications 1x2x0.5 mm<sup>2</sup> (stranded)

Copper, bare (AWG 20/19)  
Foam-skin-PE  
wh/bn  
Double core  
Polyester foil over stranded bundle  
-  
Cu braid, tinned  
PUR  
app. 8,0 mm ± 0,3 mm  
Violet similar to RAL 4001

## Drag Chain applications 4x1x0.5 mm<sup>2</sup> (stranded)

Copper, bare (AWG 20/19)  
Foam-skin-PE  
wh, bn, gn, ye  
Star quad  
Polyester foil over stranded bundle  
-  
Cu braid, tinned  
PUR  
app. 8,2 mm ± 0,3 mm  
Violet similar to RAL 4001

## Electrical data

Characteristic impedance:  
Conductor resistance, max.:  
Insulation resistance, min.:  
Loop resistance:  
Mutual capacitance:  
Test voltage:

120 Ohm ± 10 %  
34,4 Ohm/km  
5 GOhm x km  
68 Ohm/km max.  
40 nF/km nom.  
1,5 kV

120 Ohm ± 10 %  
39 Ohm/km  
5 GOhm x km  
78 Ohm/km max.  
42 nF/km nom.  
1,5 kV

## Technical data

Weight:  
bending radius, repeated:  
Operating temperature range min.:  
Operating temperature range max.:  
Caloric load, approx. value:  
Copper weight:

app. 77 kg/km  
120 mm  
-30°C  
+70°C  
-  
43,00 kg/km

app. 88 kg/km  
120 mm  
-30°C  
+70°C  
1,44 MJ/m  
-

## Norms

Applicable standards:

CAN Bus acc. to ISO 11898-2  
Acc. to ISO/IEC 11801  
Halogen-free acc. to 60754-2  
Flame-retardant acc. to IEC 60332-1-2  
CMX 75°C (shielded)  
CSA FT1

CAN Bus acc. to ISO 11898-2  
Acc. to ISO/IEC 11801  
Halogen-free acc. to 60754-2  
Flame-retardant acc. to IEC 60332-1-2  
CMX 75°C (shielded)  
CSA FT1

## Application

HELUKABEL® CAN Bus is designed for guided continuous motion in cable carriers. For long cable lengths acc. ISO 11898 (observe CAN specifications). As 1- or 2-pair (starquad) version available

## Part no.

**805685**, CAN BUS, highly flexible

**805696**, CAN BUS, highly flexible

Dimensions and specifications may be changed without prior notice.

# BUS Cables

I-BUS fixed installed



PVC

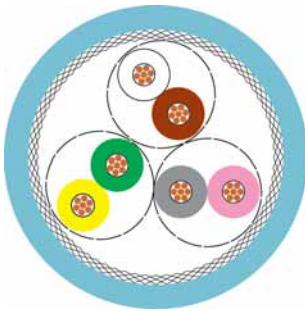

## Type Cable structure

Inner conductor diameter:  
Inner conductor diameter 2:  
Core insulation:  
Core insulation 2:  
Core colours:  
Core colours 2:  
Stranding element:  
Separator:  
Shielding 1:  
Total shielding:  
Outer sheath material:  
Cable external diameter:  
Outer sheath colour:

## Fixed installation, indoor 3x2x0.22 mm<sup>2</sup>

Copper, bare (AWG 24/7)  
-  
PE  
-  
wh/bn, gn/rd, ye/gn  
-  
Double core  
Polyester foil over stranded bundle  
-  
Cu braid, bare  
PVC  
app. 7,0 mm ± 0,3 mm  
Pastel turquoise similar to RAL 6034

## Fixed installation, indoor 3x2x0.22 mm<sup>2</sup> + 3x1.0 mm<sup>2</sup>

Copper, bare (AWG 24/7)  
Copper, bare (AWG 17/56)  
PE  
PE  
wh/bn, gn/rd, ye/gn  
bu, rd, gnye  
Double core  
Polyester foil over stranded bundle  
-  
Cu braid, bare  
PVC  
app. 8,0 mm ± 0,3 mm  
Pastel turquoise similar to RAL 6034

## Electrical data

Characteristic impedance:  
Conductor resistance, max.:  
Insulation resistance, min.:  
Loop resistance:  
Mutual capacitance:  
Test voltage:  
Attenuation:

100 Ohm ± 15 Ohm  
96 Ohm/km  
1 GOhm x km  
192 Ohm/km max.  
60 nF/km nom.  
1 kV  
256 kHz < 15,0 dB/km  
772 kHz < 24,0 dB/km  
1 MHz < 27,0 dB/km  
4 MHz < 52,0 dB/km  
10 MHz < 84,0 dB/km  
16 MHz < 112,0 dB/km  
20 MHz < 119,0 dB/km

100 Ohm ± 15 Ohm  
96 Ohm/km  
1 GOhm x km  
192 Ohm/km max.  
60 nF/km nom.  
1 kV  
256 kHz < 15,0 dB/km  
772 kHz < 24,0 dB/km  
1 MHz < 27,0 dB/km  
4 MHz < 52,0 dB/km  
10 MHz < 84,0 dB/km  
16 MHz < 112,0 dB/km  
20 MHz < 119,0 dB/km

## Technical data

Weight:  
bending radius, repeated:  
Operating temperature range min.:  
Operating temperature range max.:  
Caloric load, approx. value:  
Copper weight:

app. 70 kg/km  
110 mm  
-40°C  
+70°C  
1,20 MJ/m  
35,00 kg/km

app. 96 kg/km  
120 mm  
-40°C  
+70°C  
1,31 MJ/m  
68,00 kg/km

## Norms

Applicable standards:  
UL Style:

interbus specification 2.0, IEC61158  
Flame-retardant acc. to EN 50265-2-1  
UL Style 2571

interbus specification 2.0, IEC61158  
Flame-retardant acc. to EN 50265-2-1  
UL Style 2571

## Application

HELUKABEL® I-Bus is designed for fixed installation and occasional motion, for normal Interbus installation and as a hybrid cable with integrated power supply.

## Part no.

**80778**, I-BUS

**81202**, I-BUS

Dimensions and specifications may be changed without prior notice.

# BUS Cables

I-BUS fixed installed, halogenfree



PE

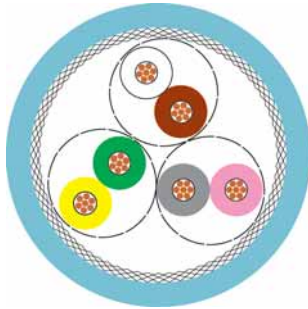

## Type Cable structure

Inner conductor diameter:  
Core insulation:  
Core colours:  
Stranding element:  
Separator:  
Shielding 1:  
Total shielding:  
Outer sheath material:  
Cable external diameter:  
Outer sheath colour:

## Fixed installation, indoor 3x2x0.22 mm<sup>2</sup>

Copper, bare (AWG 24/7)  
PE  
wh/bn, gn/rd, ye/gn  
Double core  
Polyester foil over stranded bundle  
Al-Foil  
Cu braid, bare  
PE  
app. 7,0 mm ± 0,3 mm  
Pastel turquoise similar to RAL 6034

## Electrical data

Characteristic impedance: 100 Ohm ± 15 Ohm  
Conductor resistance, max.: 96 Ohm/km  
Insulation resistance, min.: 1 GOhm x km  
Loop resistance: 192 Ohm/km max.  
Mutual capacitance: 50 nF/km nom.  
Test voltage: 1 kV  
Attenuation:  
256 kHz < 15,0 dB/km  
772 kHz < 24,0 dB/km  
1 MHz < 27,0 dB/km  
4 MHz < 52,0 dB/km  
10 MHz < 84,0 dB/km  
16 MHz < 112,0 dB/km  
20 MHz < 119,0 dB/km

## Technical data

Weight: app. 67 kg/km  
bending radius, repeated: 110 mm  
Operating temperature range min.: -25°C  
Operating temperature range max.: +60°C  
Caloric load, approx. value: 1,10 MJ/m  
Copper weight: 35,00 kg/km

## Norms

Applicable standards: interbus specification 2.0, IEC61158  
Halogen-free acc. to 60754-2

## Application

HELUKABEL® I-Bus is halogen-free and designed for fixed installation in buildings in an Interbus network. The cable is used in dry areas where its halogen-free construction is a major aspect.

## Part no.

**81557**, I-BUS

Dimensions and specifications may be changed without prior notice.

# BUS Cables

## I-BUS Drag Chain



PUR

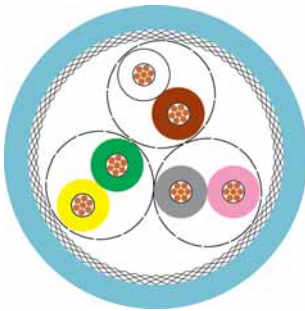

### Type Cable structure

Inner conductor diameter:  
Inner conductor diameter 2:  
Core insulation:  
Core insulation 2:  
Core colours:  
Core colours 2:  
Stranding element:  
Separator:  
Shielding 1:  
Total shielding:  
Outer sheath material:  
Cable external diameter:  
Outer sheath colour:

### Drag Chain applications 3x2x0.25 mm<sup>2</sup>

Copper, bare (AWG 24/19)  
-  
PE  
-  
wh/bn, gn/rd, ye/gn  
-  
Double core  
Polyester foil over stranded bundle  
-  
Cu braid, bare  
PUR  
app. 7,6 mm ± 0,3 mm  
Pastel turquoise similar to RAL 6034

### Drag Chain applications 3x2x0.25 mm<sup>2</sup> + 3x1.0 mm<sup>2</sup>

Copper, bare (AWG 24/19)  
Copper, bare (AWG 17/56)  
PE  
PE  
wh/bn, gn/rd, ye/gn  
bu, rd, gnye  
Double core  
Polyester foil over stranded bundle  
-  
Cu braid, bare  
PUR  
app. 8,6 mm ± 0,3 mm  
Violet similar to RAL 4001

### Electrical data

Characteristic impedance:  
Conductor resistance, max.:  
Insulation resistance, min.:  
Loop resistance:  
Mutual capacitance:  
Test voltage:  
Attenuation:

100 Ohm ± 15 Ohm  
96 Ohm/km  
1 GOhm x km  
192 Ohm/km max.  
60 nF/km nom.  
1 kV  
256 kHz < 15,0 dB/km  
772 kHz < 24,0 dB/km  
1 MHz < 27,0 dB/km  
4 MHz < 52,0 dB/km  
10 MHz < 84,0 dB/km  
16 MHz < 112,0 dB/km  
20 MHz < 119,0 dB/km

100 Ohm ± 15 Ohm  
96 Ohm/km  
1 GOhm x km  
192 Ohm/km max.  
60 nF/km nom.  
1 kV  
256 kHz < 15,0 dB/km  
772 kHz < 24,0 dB/km  
1 MHz < 27,0 dB/km  
4 MHz < 52,0 dB/km  
10 MHz < 84,0 dB/km  
16 MHz < 112,0 dB/km  
20 MHz < 119,0 dB/km

### Technical data

Weight:  
bending radius, repeated:  
Operating temperature range min.:  
Operating temperature range max.:  
Caloric load, approx. value:  
Copper weight:

app. 63 kg/km  
120 mm  
-20°C  
+70°C  
0,937 MJ/m  
36,00 kg/km

app. 92 kg/km  
130 mm  
-20°C  
+70°C  
1,227 MJ/m  
70,00 kg/km

### Norms

Applicable standards:

interbus specification 2.0, IEC61158  
Halogen-free acc. to 60754-2  
Flame-retardant acc. to EN 50265-2-1

interbus specification 2.0, IEC61158  
Halogen-free acc. to 60754-2

### Application

HELUKABEL® I-Bus is designed for guided continuous motion in cable carriers and as strictly a bus cable or a hybrid version (with integrated power supply). Both versions feature a halogen-free PUR jacket.

### Part no.

**81203**, I-BUS

**82696**, I-BUS

Dimensions and specifications may be changed without prior notice.

# BUS-Cables

Multibus I, high flexible

 **HELUKABEL®**

PUR

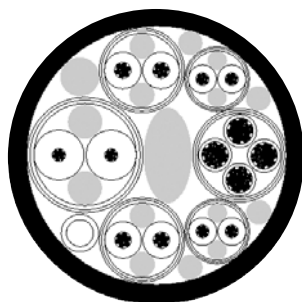

## Type

### Cable structure

Profibus:	1 x 2 x AWG 22 mm <sup>2</sup> (Foam-Skin PO/rd/gn)
DeviceNet™:	2 x 2 x AWG 22 mm <sup>2</sup> (Foam-Skin PO/wh/bn, ye/gn)
Interbus:	2 x 2 x 0,25 (Foam-Skin PO/ gn/pk, ye/gn)
Power cores:	4 x 1 x 1,0 mm <sup>2</sup> (PO/rd, bl, bu, bn)
Protective earth core:	1,0 mm <sup>2</sup> (PO/gnye)
Stranding:	Single cores totally stranded together and filled with plastic elements
Total shielding:	PP vlies
Outer sheath material:	PUR, halogenfree
Cable external diameter:	app. 14,7 mm
Outer sheath colour:	violet similar to RAL 4001

### Electrical data

Characteristic impedance:	150 + -15 Ohm (Profibus) 120 + -12 Ohm (DeviceNet™) 100 + -15 Ohm (Interbus)
Conductor resistance:	<= 20 Ohm/km (power cores + protection core) <= 70 Ohm/km (Profibus) <= 70 Ohm/km (DeviceNet™) <= 80 Ohm/km (Interbus)
Insulation resistance:	>= 500 Mohm x km (at 20° C)
Mutual capacitance:	30 pF/m nominal (Profibus) 40 pF/m nominal (DeviceNet™) 50 pF/m nominal (Interbus)
Testvoltage:	2500 V (core/ core) 1500 V (core/ screen)

### Mechanical data

Bending radius single:	<= 70 mm
Bending radius repeated:	<= 110 mm
Tensile strength static:	300 N
Tensile strength dynamic:	140 N
Oil resistance:	Diesel, IRM 902, Biohydran TM68, Ecocut HFN 10LE
Flame resistance:	IEC 60332-1, VW1/ FT1 acc. C-UL
FCKW free:	yes
Self extinguishable:	yes
Other attributes:	PVC free, free of lacquer wetting disturbing substances, siliconfree, resistant against PVC flexibiliser and cable fat RB1

### Thermal attributes

Operating temperature range:	- 40° C to + 80° C
Laying temperature range:	- 30° C to + 80° C

### Norms

Profibus standard, DeviceNet™ standard, Interbus standard

### UL-Style

VW1/ FT1 acc. C-UL, AWM style 20236

### Application

HELUKABEL® Multibus I is highly flexible with a special structure for use in cable carrier applications and robotics (use in acc. with HELU specification) in a PVC-free design. The Multibus I combines the Profibus / DeviceNet™ / Interbus bus systems as well as the power supply in a single hybrid cable.

### Part no.

**801652**, Multibus I, 15 cores

 **HELUKABEL®**

# BUS-Cables

Multibus II, high flexible

 **HELUKABEL®**

PUR



## Type Cable structure

Profibus:	1 x 2 x 0,34 mm <sup>2</sup> (Foam-Skin PO/rd/gn)
DeviceNet™:	4 x 2 x 0,34 mm <sup>2</sup> (Foam-Skin PE/ye, or, wh, bu-ye, or, wh, bu)
Power cores 1:	2 x 1,0 mm <sup>2</sup> (PO/rd, bl)
Power cores 2:	2 x 1,5 mm <sup>2</sup> (PO/bu, bn)
Protective earth core:	1,5 mm <sup>2</sup> (PO/gnye)
Stranding:	Single cores totally stranded together and filled with plastic elements
Total shielding:	PP vlies
Outer sheath material:	PUR, halogenfree
Cable external diameter:	app. 15,0 mm
Outer sheath colour:	violet similar to RAL 4001

## Electrical data

Characteristic impedance:	150 + - 15 Ohm (Profibus) 100 + - 15 Ohm (PROFINet)
Conductor resistance:	<= 20 Ohm/km (power cores + protection core) <= 70 Ohm/km (Profibus) <= 62 Ohm/km (PROFINet)
Insulation resistance:	>= 500 Mohm x km (at 20° C)
Mutual capacitance:	30 pF/m nominal (Profibus) 40 pF/m nominal (PROFINet)
Testvoltage:	2500 V (core/ core) 1500 V (core/ screen)

## Mechanical data

Bending radius single:	<= 70 mm
Bending radius repeated:	<= 110 mm
Tensile strength static:	300 N
Tensile strength dynamic:	140 N
Oil resistance:	Diesel, IRM 902, Biohydran TM68, Ecocut HFN 10LE
Flame resistance:	IEC 60332-1, VW1/ FT1 acc. C-UL
FCKW free:	yes
Self extinguishable:	yes
Other attributes:	PVC free, free of lacquer wetting disturbing substances, siliconfree, resistant against PVC flexibiliser and cable fat RB1

## Thermal attributes

Operating temperature range:	- 40° C to + 80° C
Laying temperature range:	- 20° C to + 80° C

## Norms

### UL-Style

### Application

Profibus standard, PROFINet standard  
VW1/ FT1 acc. C-UL, AWM style 20236

HELUKABEL® Multibus II is highly flexible with a special structure for use in cable carrier applications and robotics (use in acc. with HELU specification) in a PVC-free design. The Multibus II (further development of Multibus I) combines the Profibus /Profinet bus systems as well as the power supply in a single hybrid cable.

## Part no.

**804115**, Multibus II, 15 cores



# BUS Cables

## A-BUS EPDM



EPDM

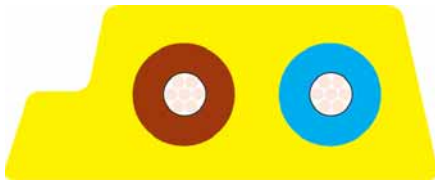

### Type Cable structure

Inner conductor:  
Core insulation:  
Core colours:  
Separator:  
Shielding 1:  
Total shielding:  
Outer sheath material:  
Outer sheath colour:

### Actuator Sensor Interface 2x1.5 mm<sup>2</sup>

Copper, tinned  
Rubber compound  
bu, bn  
-  
-  
EPDM  
Yellow similar to RAL 1023

### Actuator Sensor Interface 2x1.5 mm<sup>2</sup>

Copper, tinned  
Rubber compound  
bu, bn  
-  
-  
EPDM  
Black similar to RAL 9005

### Electrical data

Conductor resistance, max.:  
Insulation resistance, min.:  
Loop resistance:  
Nominal voltage:  
Test voltage:

13,7 Ohm/km  
1 GOhm x km  
27 Ohm/km max.  
32 V  
1 kV at 15 min.

13,7 Ohm/km  
1 GOhm x km  
27 Ohm/km max.  
48 V  
1 kV at 15 min.

### Technical data

Weight:  
bending radius, repeated:  
Operating temperature range min.:  
Operating temperature range max.:  
Caloric load, approx. value:  
Copper weight:

app. 70 kg/km  
30 mm  
-40°C  
+85°C  
0,975 MJ/m  
31,00 kg/km

app. 70 kg/km  
30 mm  
-40°C  
+85°C  
0,975 MJ/m  
31,00 kg/km

### Norms

Applicable standards:

ASI standard  
Halogen-free acc. to 60754-2

ASI standard  
Halogen-free acc. to 60754-2

### Application

HELUKABEL® A-Bus EPDM Rubber for normal use in an AS-I system. Applications include wet/dry areas where the properties of a rubber jacket are desired. In addition, this material offers benefits such as low compression forces needed when contacting and the best sealing against the AS-I module.

### Part no.

**80824**, A-BUS EPDM

**80825**, A-BUS EPDM

Dimensions and specifications may be changed without prior notice.

# BUS Cables

A-BUS EPDM, Long Distance

 **HELUKABEL®**

EPDM

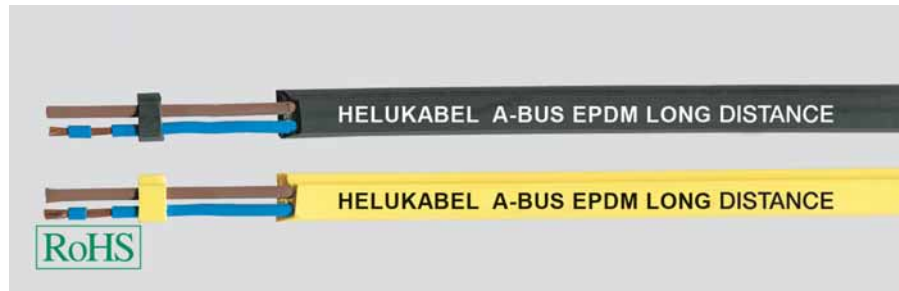
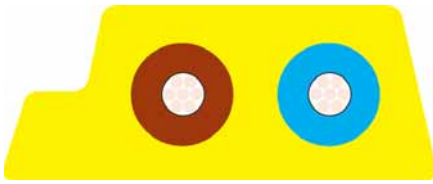

## Type Cable structure

Inner conductor:  
Core insulation:  
Core colours:  
Separator:  
Shielding 1:  
Total shielding:  
Outer sheath material:  
Outer sheath colour:

## Industrial Area 2x2.5 mm<sup>2</sup>

Copper, tinned  
Rubber compound  
bu, bn  
-  
-  
-  
EPDM  
Yellow similar to RAL 1023

## Industrial Area 2x2.5 mm<sup>2</sup>

Copper, tinned  
Rubber compound  
bu, bn  
-  
-  
-  
EPDM  
Black similar to RAL 9005

## Electrical data

### Technical data

Weight:  
bending radius, repeated:  
Operating temperature range min.:  
Operating temperature range max.:  
Caloric load, approx. value:  
Copper weight:

app. 130 kg/km  
35 mm  
-40°C  
+85°C  
0,70 MJ/m  
49,00 kg/km

app. 130 kg/km  
30 mm  
-40°C  
+85°C  
0,70 MJ/m  
49,00 kg/km

## Norms

Applicable standards:

ASI standard  
Halogen-free acc. to 60754-2

ASI standard  
Halogen-free acc. to 60754-2

## Application

HELUKABEL® A-Bus Long Distance EPDM Rubber 2,5mm<sup>2</sup> for normal use in an AS-I system. The enlarged cross-section allows bigger transmission distances, higher ampacity and this results in savings of supplementary power packs. Applications include wet/dry areas where the properties of a rubber jacket are desired. In addition, this material offers benefits such as low compression forces needed when contacting and the best sealing against the AS-I module.

## Part no.

**804408**, A-BUS EPDM

**804409**, A-BUS EPDM

Dimensions and specifications may be changed without prior notice.

# BUS Cables

A-BUS PUR, UL/CSA

**HELUKABEL®**

PUR

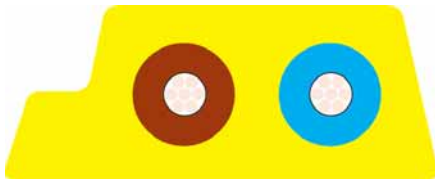

## Type Cable structure

Inner conductor:  
Core insulation:  
Core colours:  
Separator:  
Shielding 1:  
Total shielding:  
Outer sheath material:  
Outer sheath colour:

## Actuator Sensor Interface 2x1.5 mm<sup>2</sup>

Copper, tinned  
PO  
bu, bn  
-  
-  
PUR  
Yellow similar to RAL 1023

## Actuator Sensor Interface 2x1.5 mm<sup>2</sup>

Copper, tinned  
PO  
bu, bn  
-  
-  
PUR  
Black similar to RAL 9005

## Electrical data

Conductor resistance, max.:  
Insulation resistance, min.:  
Loop resistance:  
Nominal voltage:  
Test voltage:

13,7 Ohm/km  
1 GOhm x km  
27 Ohm/km max.  
32 V  
1 kV at 15 min.

13,7 Ohm/km  
1 GOhm x km  
27 Ohm/km max.  
48 V  
1 kV at 15 min.

## Technical data

Weight:  
bending radius, repeated:  
Operating temperature range min.:  
Operating temperature range max.:  
Caloric load, approx. value:  
Copper weight:

app. 64 kg/km  
30 mm  
-40°C  
+80°C  
0,965 MJ/m  
31,00 kg/km

app. 64 kg/km  
30 mm  
-40°C  
+80°C  
0,965 MJ/m  
31,00 kg/km

## Norms

Applicable standards:

ASI standard  
Halogen-free acc. to 60754-2  
Flame-retardant acc. to IEC 60332-1-2  
AWM Style 20549  
CSA FT2

ASI standard  
Halogen-free acc. to 60754-2  
Flame-retardant acc. to IEC 60332-1-2  
AWM Style 20549  
CSA FT2

## Application

HELUKABEL® A-Bus PUR is ideal for use in wet/dry areas thanks to its outstanding characteristics when exposed to common coolants/lubricants. This version can also be used in cable carriers (special installation conditions must be observed: place wide cable side on inside radius, use partitions and install flat/round cables separately). These types are approved for use in the American market (UL 1581, FT2) thanks to use of special materials.

## Part no.

**82434**, A-BUS PUR

**82822**, A-BUS PUR

Dimensions and specifications may be changed without prior notice.

# BUS Cables

A-BUS PUR 2X2.5 PUR, Long Distance, UL/CSA

 **HELUKABEL®**

PUR

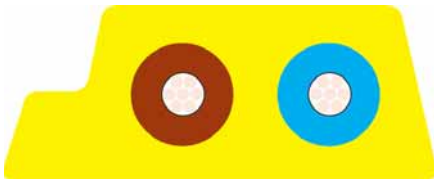

## Type Cable structure

Inner conductor:  
Core insulation:  
Core colours:  
Separator:  
Shielding 1:  
Total shielding:  
Outer sheath material:  
Outer sheath colour:

## Drag Chain applications 2x2.5 mm<sup>2</sup>

Copper, tinned  
PO  
bu, bn  
-  
-  
-  
PUR  
Yellow similar to RAL 1023

## Drag Chain applications 2x2.5 mm<sup>2</sup>

Copper, tinned  
PO  
bu, bn  
-  
-  
-  
PUR  
Black similar to RAL 9005

## Electrical data

Conductor resistance, max.:  
Loop resistance:  
Nominal voltage:

8,21 Ohm/km  
16 Ohm/km max.  
32 V

8,21 Ohm/km  
16 Ohm/km max.  
48 V

## Technical data

Weight:  
bending radius, repeated:  
Operating temperature range min.:  
Operating temperature range max.:  
Caloric load, approx. value:  
Copper weight:

app. 140 kg/km  
30 mm  
-40°C  
+80°C  
0,90 MJ/m  
49,00 kg/km

app. 140 kg/km  
30 mm  
-40°C  
+80°C  
0,90 MJ/m  
49,00 kg/km

## Norms

Applicable standards:

ASI standard  
Halogen-free acc. to 60754-2  
Flame-retardant CSA FT2  
AWM Style 20549  
CSA FT2

ASI standard  
Halogen-free acc. to 60754-2  
Flame-retardant CSA FT2  
AWM Style 20549  
CSA FT2

## Application

AS components are interconnected with this special system cable. With the AS interface, the cable assembly from the control system to the sensor/actuator is not needed. The AS interface is the field bus system that transmits both data and power in one single cable. With fast contacting in penetration technique, the possibility of errors in cabling is largely reduced. The special outer jacket provides protection against oil, grease, and refrigerant lubricants, and the cable is therefore even suitable for applications in wet surroundings, in machinery and plant construction, as well as in the machine tool and automotive industry. The PUR variant is suitable for heavy-duty industrial environments.

Because of the cross section 2,5qmm it is possible to realize longer distances.

These types are certified for the American market (UL 1581, FT2) through the use of special materials.

## Part no.

**804410**, A-BUS PUR

**804411**, A-BUS PUR

Dimensions and specifications may be changed without prior notice.

# BUS Cables

A-BUS TPE, UL CMG

**HELUKABEL®**

TPE 105°

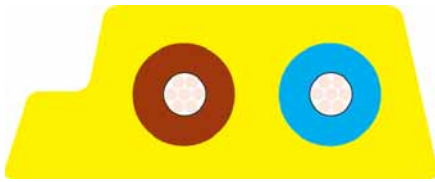

NEW

## Type Cable structure

Inner conductor:  
Core insulation:  
Core colours:  
Separator:  
Shielding 1:  
Total shielding:  
Outer sheath material:  
Outer sheath colour:

## Mobile use 2x1.5 mm<sup>2</sup>

Copper, tinned  
TPE  
bu, bn  
-  
-  
TPE  
Yellow

## Mobile use 2x1.5 mm<sup>2</sup>

Copper, tinned  
TPE  
bu, bn  
-  
-  
TPE  
Black

## Electrical data

Conductor resistance, max.:  
Insulation resistance, min.:  
Loop resistance:  
Nominal voltage:  
Test voltage:

13,7 Ohm/km  
1 GOhm x km  
27 Ohm/km max.  
32 V  
1,5 kV at 15 min.

13,7 Ohm/km  
1 GOhm x km  
27 Ohm/km max.  
48 V  
1,5 kV at 15 min.

## Technical data

Weight:  
bending radius, repeated:  
Operating temperature range min.:  
Operating temperature range max.:  
Caloric load, approx. value:  
Copper weight:

app. 71 kg/km  
24 mm  
-40°C  
+105°C  
1,10 MJ/m  
31,00 kg/km

app. 70 kg/km  
24 mm  
-40°C  
+105°C  
1,10 MJ/m  
31,00 kg/km

## Norms

Applicable standards:  
UL Style:  
CSA standard:

ASI standard  
Flame-retardant acc. to IEC 60332-1-2  
CL2 CMG  
CSA FT 4

ASI standard  
Flame-retardant acc. to IEC 60332-1-2  
CL2 CMG  
CSA FT 4

## Application

HELUKABEL® A-Bus TPE UL/CSA for demanding temperature requirements up to 105 °C and with improved flame retardance specifically for the American market. The special outer sheath makes the cable resistant to many oils, greases and cooling lubricants and thus suitable for applications in wet surroundings, in machinery and plant construction as well as in the machine tool and automotive industries.

## Part no.

**805693**, A-BUS UL

**805694**, A-BUS UL

Dimensions and specifications may be changed without prior notice.

# BUS Cables

A-BUS TPE

 **HELUKABEL®**

TPE

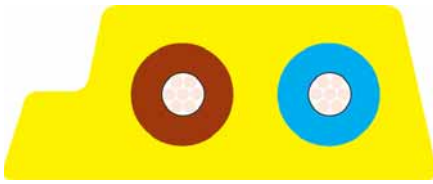

## Type Cable structure

Inner conductor:  
Core insulation:  
Core colours:  
Separator:  
Shielding 1:  
Total shielding:  
Outer sheath material:  
Outer sheath colour:

## Actuator Sensor Interface 2x1.5 mm<sup>2</sup>

Copper, tinned  
TPE  
bu, bn  
-  
-  
-  
TPE  
Yellow

## Actuator Sensor Interface 2x1.5 mm<sup>2</sup>

Copper, tinned  
TPE  
bu, bn  
-  
-  
-  
TPE  
Black

## Electrical data

Conductor resistance, max.:  
Insulation resistance, min.:  
Loop resistance:  
Nominal voltage:  
Test voltage:

13,7 Ohm/km  
1 GOhm x km  
27 Ohm/km max.  
32 V  
1,5 kV at 15 min.

13,7 Ohm/km  
1 GOhm x km  
27 Ohm/km max.  
48 V  
1,5 kV at 15 min.

## Technical data

Weight:  
bending radius, repeated:  
Operating temperature range min.:  
Operating temperature range max.:  
Caloric load, approx. value:  
Copper weight:

app. 70 kg/km  
24 mm  
-40°C  
+105°C  
1,10 MJ/m  
31,00 kg/km

app. 70 kg/km  
24 mm  
-40°C  
+105°C  
1,10 MJ/m  
31,00 kg/km

## Norms

Applicable standards:

ASI standard  
Flame-retardant acc. to IEC 60332-1-2

ASI standard  
Flame-retardant acc. to IEC 60332-1-2

## Application

HELUKABEL® A-Bus TPE for demanding temperature requirements up to 105 °C and flame retardance. The special outer sheath makes the cable resistant to many oils, greases and cooling lubricants and thus suitable for applications in wet surroundings, in machinery and plant construction as well as in the machine tool and automotive industries.

## Part no.

**801846**, A-BUS TPE

**801847**, A-BUS TPE

Dimensions and specifications may be changed without prior notice.

# BUS Cables

AS-Interface Electrical Cabinet FLIH

 **HELUKABEL®**

FRNC

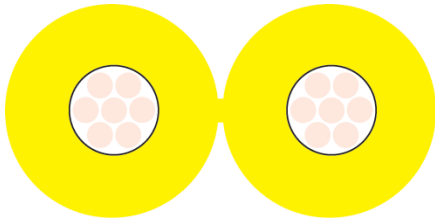

## Type Cable structure

Inner conductor:  
Separator:  
Shielding 1:  
Total shielding:  
Outer sheath material:  
Outer sheath colour:

## Fixed installation, indoor 2x0,86/ 2,5

Copper, tinned  
-  
-  
-  
FRNC  
Yellow

## Electrical data

Characteristic impedance: 105 Ohm  $\pm$  35 Ohm  
Conductor resistance, max.: 23 Ohm/km  
Insulation resistance, min.: 0,01 GOhm x km  
Loop resistance: 46 Ohm/km max.  
Nominal voltage: 300 V  
Test voltage: 2 kV at 15 min.

## Technical data

Weight: app. 24 kg/km  
bending radius, repeated: 30 mm  
Operating temperature range min.: -25°C  
Operating temperature range max.: +70°C  
Caloric load, approx. value: 0,30 MJ/m  
Copper weight: 20,00 kg/km

## Norms

Applicable standards: ASI standard  
Halogen-free acc. to 60754-2  
Flame-retardant acc. to IEC 60332-1-2  
UL Style: UL Style 2444

## Application

HELUKABEL® AS-Interface FLIH for electrical cabinet applications, especially for wiring inside electrical cabinets. Compared to "normal" AS-I wire, less space is needed and routing is improved. This cable is also designed for appropriate fast contacting through use of the penetration technique. Special modules for electrical cabinets that are compatible with this wire are available on the market.

## Part no.

**802183**, AS-Interface FLIH

Dimensions and specifications may be changed without prior notice.

# BUS Cables

DeviceNet™ fixed installed thick + thin

 **HELUKABEL®**

PVC

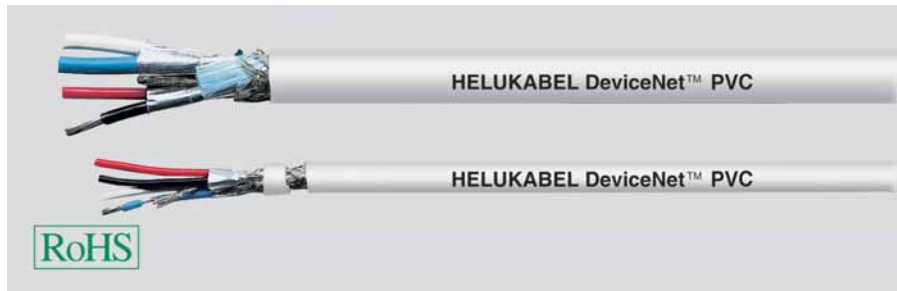
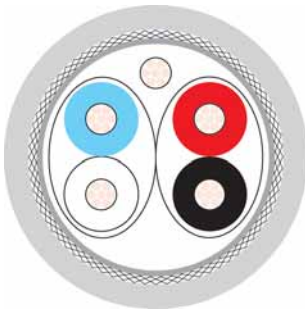

## Type Cable structure

Inner conductor diameter 1:  
Inner conductor diameter 2:  
Core insulation 1:  
Core insulation 2:  
Core colours 1:  
Core colours 2:  
Stranding element 1:  
Separator:  
Shielding 1:  
Total shielding:  
Drain wire:  
Outer sheath material:  
Cable external diameter:  
Outer sheath colour:

## Fixed installation, indoor 1x2xAWG18 + 1x2xAWG15

Copper, tinned (AWG 18/19)  
Copper, tinned (AWG 15/19)  
Foam-skin-PE  
PVC  
light bu, wh  
rd, bk  
Double core  
-  
Al-Foil  
Cu braid, tinned  
yes  
PVC  
app. 12,2 mm ± 0,3 mm  
Grey similar to RAL 7001

## Fixed installation, indoor 1x2xAWG24 + 1x2xAWG22

Copper, tinned (AWG 24/19)  
Copper, tinned (AWG 22/19)  
Foam-skin-PE  
PVC  
light bu, wh  
rd, bk  
Double core  
-  
Al-Foil  
Copper shifting, tinned  
yes  
PVC  
app. 6,9 mm ± 0,3 mm  
Grey similar to RAL 7001

## Electrical data

Characteristic impedance:  
Conductor resistance, max.:  
Insulation resistance, min.:  
Loop resistance:  
Mutual capacitance:  
Test voltage:  
Attenuation:

120 Ohm ± 10 %  
22,6 Ohm/km  
0,2 GOhm x km  
45 Ohm/km max.  
39,8 nF/km nom.  
2 kV  
125 kHz < 4,2 dB/km  
500 kHz < 8,1 dB/km

120 Ohm ± 10 %  
90 Ohm/km  
0,2 GOhm x km  
180 Ohm/km max.  
39,8 nF/km nom.  
2 kV  
125 kHz < 9.5 dB/km  
500 kHz < 16.4 dB/km

## Technical data

Weight:  
bending radius, repeated:  
Operating temperature range min.:  
Operating temperature range max.:  
Caloric load, approx. value:  
Copper weight:

app. 192 kg/km  
190 mm  
-20°C  
+80°C  
2,92 MJ/m  
88,00 kg/km

app. 67 kg/km  
110 mm  
-20°C  
+80°C  
0,91 MJ/m  
35,00 kg/km

## Norms

Applicable standards:  
UL Style:  
CSA standard:

ODVA DeviceNet  
Flame-retardant acc. to IEC 60332-3  
CMG 75°C PLTC FT4  
CEC: CMG FT4

ODVA DeviceNet  
Flame-retardant acc. to IEC 60332-3  
CMG 75°C PLTC FT4  
CSA FT 4

## Application

HELUKABEL® DeviceNet™ PVC for fixed installation. The special aspect of this bus system is that a data pair and a power supply pair are **always** integrated in one cable. The small cross-section is used for short distances or as a point-to-point connection; the large cross-section as main conductor for long distances and frequently in combination with the thin conductor as drain wire.

## Part no.

**800683**, DeviceNet PVC

**800684**, DeviceNet PVC

Dimensions and specifications may be changed without prior notice.



# BUS Cables

DeviceNet™ fixed installed thick + thin



FRNC

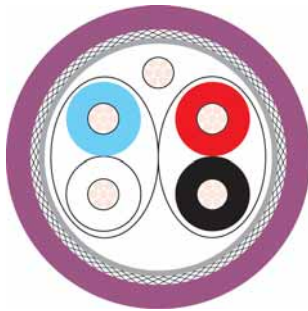

## Type Cable structure

Inner conductor diameter 1:  
Inner conductor diameter 2:  
Core insulation 1:  
Core insulation 2:  
Core colours 1:  
Core colours 2:  
Stranding element 1:  
Separator:  
Shielding 1:  
Total shielding:  
Drain wire:  
Outer sheath material:  
Cable external diameter:  
Outer sheath colour:

## Fixed installation, indoor 1x2xAWG18 + 1x2xAWG15

Copper, tinned (AWG 18/19)  
Copper, tinned (AWG 15/19)  
Cell PE  
PE  
light bu, wh  
rd, bk  
Double core  
-  
Al-Foil  
Cu braid, tinned  
yes  
FRNC  
app. 12,2 mm ± 0,3 mm  
Violet similar to RAL 4001

## Fixed installation, indoor 1x2xAWG24 + 1x2xAWG22

Copper, tinned (AWG 24/19)  
Copper, tinned (AWG 22/19)  
Cell PE  
PE  
light bu, wh  
rd, bk  
Double core  
-  
Al-Foil  
Cu braid, tinned  
yes  
FRNC  
app. 6,9 mm ± 0,3 mm  
Violet similar to RAL 4001

## Electrical data

Characteristic impedance:  
Conductor resistance, max.:  
Insulation resistance, min.:  
Loop resistance:  
Mutual capacitance:  
Test voltage:  
Attenuation:

120 Ohm ± 10 %  
22,6 Ohm/km  
0,2 GOhm x km  
45 Ohm/km max.  
39 nF/km nom.  
2 kV  
125 kHz < 4.2 dB/km  
500 kHz < 8.1 dB/km

120 Ohm ± 10 %  
90 Ohm/km  
0,2 GOhm x km  
180 Ohm/km max.  
39,8 nF/km nom.  
2 kV  
125 kHz < 9.5 dB/km  
500 kHz < 16.4 dB/km

## Technical data

Weight:  
bending radius, repeated:  
Operating temperature range min.:  
Operating temperature range max.:  
Caloric load, approx. value:  
Copper weight:

app. 195 kg/km  
190 mm  
-25°C  
+80°C  
2,73 MJ/m  
88,00 kg/km

app. 70 kg/km  
110 mm  
-25°C  
+80°C  
0,82 MJ/m  
34,00 kg/km

## Norms

Applicable standards:

ODVA DeviceNet  
Halogen-free acc. to 60754-2  
Flame-retardant acc. to EN 50265-2-1  
CL2 CMG  
CEC: CMG FT4

ODVA DeviceNet  
Halogen-free acc. to 60754-2  
Flame-retardant acc. to EN 50265-2-1  
CL2 CMG  
CEC: CMG FT4

## Application

HELUKABEL® DeviceNet™ FRNC for fixed installation in areas where high flame retardance and a halogen-free design are needed. The special aspect of this bus system is that a data pair and a power supply pair are **always** integrated in one cable. The small cross-section is used for short distances or as a point-to-point connection; the large cross-section as main conductor for long distances and frequently in combination with the thin conductor as drain wire.

## Part no.

**800681**, DeviceNet FRNC

**800682**, DeviceNet FRNC

Dimensions and specifications may be changed without prior notice.

# BUS Cables

DeviceNet™ fixed installed thick + thin

**HELUKABEL®**

CPE

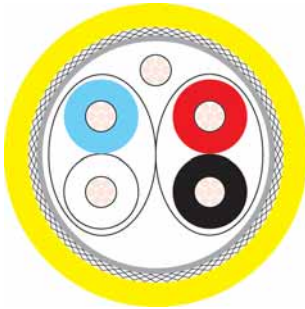

## Type Cable structure

Inner conductor diameter 1:  
Inner conductor diameter 2:  
Core insulation 1:  
Core insulation 2:  
Core colours 1:  
Core colours 2:  
Stranding element 1:  
Separator:  
Shielding 1:  
Total shielding:  
Drain wire:  
Outer sheath material:  
Cable external diameter:  
Outer sheath colour:

## Fixed installation, indoor 1x2xAWG18 + 1x2xAWG15

Copper, tinned (AWG 18/19)  
Copper, tinned (AWG 15/19)  
Cell PE  
PE  
light bu, wh  
rd, bk  
Double core  
-  
Al-Foil  
Cu braid, tinned  
yes  
CPE  
app. 12,0 mm ± 0,3 mm  
Yellow

## Fixed installation, indoor 1x2xAWG24 + 1x2xAWG22

Copper, tinned (AWG 24/19)  
Copper, tinned (AWG 22/19)  
PE  
PVC  
light bu, wh  
rd, bk  
Double core  
-  
Al-Foil  
Cu braid, tinned  
yes  
CPE  
app. 7,0 mm ± 0,3 mm  
Yellow

## Electrical data

Characteristic impedance:  
Conductor resistance, max.:  
Insulation resistance, min.:  
Loop resistance:  
Mutual capacitance:  
Test voltage:  
Attenuation:

120 Ohm ± 10 %  
22,6 Ohm/km  
0,2 GOhm x km  
45 Ohm/km max.  
39 nF/km nom.  
2 kV  
125 kHz < 4.3 dB/km  
500 kHz < 8.2 dB/km

120 Ohm ± 10 %  
90 Ohm/km  
0,2 GOhm x km  
180 Ohm/km max.  
39 nF/km nom.  
2 kV  
125 kHz < 9.5 dB/km  
500 kHz < 16.4 dB/km

## Technical data

Weight:  
bending radius, repeated:  
Operating temperature range min.:  
Operating temperature range max.:  
Caloric load, approx. value:  
Copper weight:

app. 195 kg/km  
190 mm  
-20°C  
+60°C  
2,73 MJ/m  
71,20 kg/km

app. 70 kg/km  
110 mm  
-20°C  
+60°C  
0,82 MJ/m  
28,10 kg/km

## Norms

Applicable standards:  
UL Style:  
CSA standard:

ODVA DeviceNet  
Flame-retardant acc. to EN 50265-2-1  
CMG PLTC  
CEC: CMG FT4

ODVA DeviceNet  
Flame-retardant acc. to EN 50265-2-1  
CL2 CMG  
CEC: CMG FT4

## Application

HELUKABEL® DeviceNet™ CPE for fixed installation with very high flame-retardance requirements. The special aspect of this bus system is that a data pair and a power supply pair are **always** integrated in one cable. The small cross-section is used for short distances or as a point-to-point connection; the large cross-section as main conductor for long distances and frequently in combination with the thin conductor as drain wire.

## Part no.

**81907**, DeviceNet CPE

**81908**, DeviceNet CPE

Dimensions and specifications may be changed without prior notice.

# BUS Cables

DeviceNet™ high flexible thick + thin



PUR, high flexible

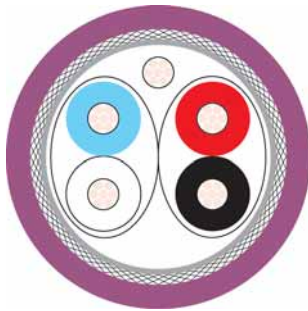

## Type Cable structure

Inner conductor diameter 1:  
Inner conductor diameter 2:  
Core insulation 1:  
Core insulation 2:  
Core colours 1:  
Core colours 2:  
Stranding element 1:  
Separator:  
Shielding 1:  
Total shielding:  
Drain wire:  
Outer sheath material:  
Cable external diameter:  
Outer sheath colour:

## Drag Chain applications

### 1x2xAWG18 + 1x2xAWG15

Copper, tinned (AWG 18/40)  
Copper, tinned (AWG 15/84)  
Cell PE  
PE  
light bu, wh  
rd, bk  
Double core  
-  
Al-Foil  
Cu braid, tinned  
yes  
PUR  
app. 12,2 mm ± 0,3 mm  
Violet similar to RAL 4001

## Drag Chain applications

### 1x2xAWG24 + 1x2xAWG22

Copper, tinned (AWG 24/19)  
Copper, tinned (AWG 22/19)  
Cell PE  
PE  
light bu, wh  
rd, bk  
Double core  
-  
Al-Foil  
Cu braid, tinned  
yes  
PUR  
app. 6,9 mm ± 0,3 mm  
Violet similar to RAL 4001

## Electrical data

Characteristic impedance:  
Conductor resistance, max.:  
Insulation resistance, min.:  
Loop resistance:  
Mutual capacitance:  
Test voltage:  
Attenuation:

120 Ohm ± 10 %  
22,6 Ohm/km  
0,2 GOhm x km  
45 Ohm/km max.  
39,8 nF/km nom.  
2 kV  
125 kHz < 4.1 dB/km  
500 kHz < 8.2 dB/km

120 Ohm ± 10 %  
90 Ohm/km  
0,2 GOhm x km  
45 Ohm/km max.  
39,8 nF/km nom.  
2 kV  
125 kHz < 9.5 dB/km  
500 kHz < 16.4 dB/km

## Technical data

Weight:  
bending radius, repeated:  
Operating temperature range min.:  
Operating temperature range max.:  
Caloric load, approx. value:  
Copper weight:

app. 185 kg/km  
61 mm  
-40°C  
+80°C  
2,54 MJ/m  
90,00 kg/km

app. 68 kg/km  
70 mm  
-40°C  
+80°C  
0,76 MJ/m  
35,00 kg/km

## Norms

Applicable standards:

ODVA DeviceNet  
Halogen-free acc. to 60754-2  
Flame-retardant acc. to EN 50265-2-1  
CMX 75°C CL2X

ODVA DeviceNet  
Halogen-free acc. to 60754-2  
Flame-retardant acc. to EN 50265-2-1  
CMX 75°C CL2X

## Application

HELUKABEL® DeviceNet™ PUR highly flexible for use in cable carriers with outstanding resistance to common coolants/lubricants. The special aspect of this bus system is that a data pair and a power supply pair are **always** integrated in one cable. The small cross-section is used for short distances or as a point-to-point connection; the large cross-section as main conductor for long distances and frequently in combination with the thin conductor as drain wire.

## Part no.

**81909**, DeviceNet PUR

**81910**, DeviceNet PUR

Dimensions and specifications may be changed without prior notice.

# BUS Cables

CC-Link BUS fixed installed

**HELUKABEL®**

PVC

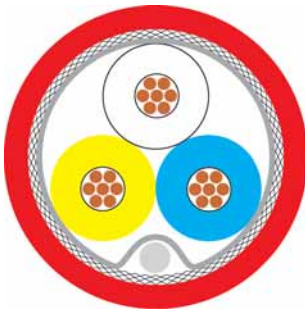

## Type

### Cable structure

Inner conductor diameter:  
Core insulation:  
Core colours:  
Stranding element:  
Separator:  
Shielding 1:  
Total shielding:  
Drain wire:  
Outer sheath material:  
Cable external diameter:  
Outer sheath colour:

## Fixed installation, indoor

### 3x0.5 mm<sup>2</sup>

Copper, bare (AWG 20/7)  
Foam-skin-PE  
wh, bu, ye  
Triple core  
Polyester foil over stranded bundle  
Al-Foil  
Cu braid, tinned  
yes  
PVC  
app. 7,7 mm ± 0,3 mm  
Red

## Electrical data

Characteristic impedance: 110 Ohm ± 15 Ohm  
Conductor resistance, max.: 37,8 Ohm/km  
Insulation resistance, min.: 10 GOhm x km  
Loop resistance: 75 Ohm/km max.  
Mutual capacitance: 60 nF/km nom.  
Test voltage: 2 kV  
Attenuation: 1 MHz < 16,0 dB/100m  
5 MHz < 35,0 dB/100m

## Technical data

Weight: app. 77 kg/km  
bending radius, repeated: 120 mm  
Operating temperature range min.: -40°C  
Operating temperature range max.: +75°C  
Caloric load, approx. value: 1,10 MJ/m  
Copper weight: 40,00 kg/km

## Norms

Applicable standards: CC-Link Specification 1.10  
Flame-retardant acc. to EN 50265-2-1  
UL Style: CM 75°C or PLTC  
CSA standard: CSA FT 4

## Application

HELUKABEL® CC-Link Bus PVC for fixed installation. The primary market is Asia, but the USA and the United Kingdom are using CC-Link increasingly. The cable has the appropriate approvals for these markets. A version with power supply conductors is optionally available. It is used particularly in channels.

## Part no.

**800497**, CC-Link communications cable

Dimensions and specifications may be changed without prior notice.

# BUS Cables

SafetyBUS fixed installed + high flexible

**HELUKABEL**<sup>®</sup>

FRNC + PUR

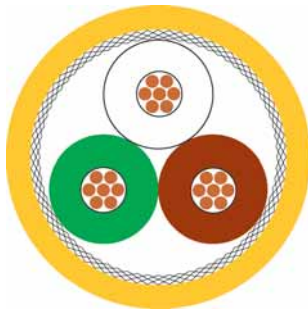

## Type

### Cable structure

Inner conductor diameter:  
Core insulation:  
Core colours:  
Stranding element:  
Separator:  
Shielding 1:  
Total shielding:  
Outer sheath material:  
Cable external diameter:  
Outer sheath colour:

### Electrical data

Characteristic impedance:  
Conductor resistance, max.:  
Insulation resistance, min.:  
Loop resistance:  
Mutual capacitance:  
Nominal voltage:  
Test voltage:  
Attenuation:

### Technical data

Weight:  
bending radius, repeated:  
Operating temperature range min.:  
Operating temperature range max.:  
Caloric load, approx. value:  
Copper weight:

### Norms

Applicable standards:

UL Style:

### Application

HELUKABEL<sup>®</sup> SafetyBUS FRNC for fixed installation; the PUR version is intended for use in cable carriers. Both versions are halogen-free.

### Part no.

Dimensions and specifications may be changed without prior notice.

### Fixed installation, indoor 3x0,75 mm<sup>2</sup> (stranded)

Copper, bare (AWG 18/24)  
Foam-skin-PE  
wh, bn, gn  
Triple core  
Polyester foil over stranded bundle  
-  
Cu braid, tinned  
FRNC  
app. 7,5 mm ± 0,3 mm  
Yellow similar to RAL 1003

110 Ohm ± 10 Ohm  
27,7 Ohm/km  
5 GOhm x km  
52 Ohm/km max.  
45 nF/km nom.  
250 V  
3 kV  
1 MHz < 1,6 dB/km  
5 MHz < 3,4 dB/km  
10 MHz < 5,6 dB/km  
16 MHz < 7,5 dB/km

app. 68 kg/km  
75 mm  
-25°C  
+80°C  
0,72 MJ/m  
50,00 kg/km

abuttet at SafetyBUS p technical guidelines  
copper wires 1.0  
Halogen-free acc. to 60754-2  
Flame-retardant acc. to IEC 60332-3  
-

### Drag Chain applications 3x0,75 mm<sup>2</sup> (stranded)

Copper, bare (AWG 18)  
Foam-skin-PE  
wh, bn, gn  
Triple core  
Polyester foil over stranded bundle  
-  
Cu braid, tinned  
PUR  
app. 7,8 mm ± 0,2 mm  
Yellow similar to RAL 1003

110 Ohm ± 10 Ohm  
26 Ohm/km  
5 GOhm x km  
52 Ohm/km max.  
45 nF/km nom.  
250 V  
3 kV  
1 MHz < 1,6 dB/km  
5 MHz < 3,4 dB/km  
10 MHz < 5,6 dB/km  
16 MHz < 7,5 dB/km

app. 65 kg/km  
80 mm  
-30°C  
+80°C  
0,76 MJ/m  
50,00 kg/km

abuttet at SafetyBUS p technical guidelines  
copper wires 1.0  
Halogen-free acc. to 60754-2  
Flame-retardant acc. to IEC 60332-1-2  
CMX 75°C (shielded)

**800652**, SafetyBus p

# BUS Cables

LON BUS H122 + Y116

**HELUKABEL®**

FRNC + PVC

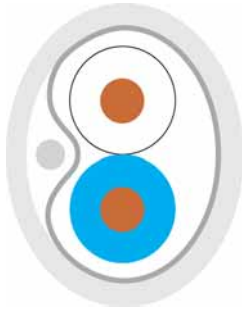

## Type

### Cable structure

Inner conductor diameter:  
Core insulation:  
Core colours:  
Stranding element:  
Separator:  
Shielding 1:  
Total shielding:  
Drain wire:  
Outer sheath material:  
Cable external diameter:  
Outer sheath colour:

## Fixed installation, indoor

### 1x2xAWG 22/1

Copper, tinned (AWG 22/1)  
PE  
wh, bu  
Double core  
Polyester foil over stranded bundle  
-  
Al-Foil  
yes  
FRNC  
app. 4,4 mm ± 0,3 mm  
White

## Mobile use

### 1x2xAWG 16/19

Copper, tinned (AWG 16/19)  
PVC  
wh, bk  
Double core  
Polyester foil over stranded bundle  
-  
-  
-  
PVC  
app. 7,0 mm ± 0,4 mm  
Grey

## Electrical data

Characteristic impedance:  
Conductor resistance, max.:  
Insulation resistance, min.:  
Loop resistance:  
Mutual capacitance:  
Nominal voltage:  
Test voltage:

100 Ohm ± 10 %  
57 Ohm/km  
5 GOhm x km  
114 Ohm/km max.  
45 nF/km nom.  
125 V  
0,7 kV

85 Ohm ± 15 %  
15,8 Ohm/km  
0,02 GOhm x km  
31 Ohm/km max.  
10 nF/km nom.  
300 V  
2 kV

## Technical data

Weight:  
bending radius, repeated:  
Operating temperature range min.:  
Operating temperature range max.:  
Caloric load, approx. value:  
Copper weight:  
Applicable standards:

app. 25 kg/km  
70 mm  
-20°C  
+75°C  
0,337 MJ/m  
11,00 kg/km  
Halogen-free acc. to 60754-2  
Flame-retardant acc. to IEC 60332-1-2

app. 65 kg/km  
85 mm  
-20°C  
+80°C  
1,25 MJ/m  
30,00 kg/km  
Flame-retardant acc. to IEC 60332-1-2

## Application

HELUKABEL® LON BUS H122 FRNC for fixed installation; version Y116 for mobile applications. For both versions: Use indoors is in fixed installations (H122) and as a patch cable (Y116) and must comply with DIN EN 50090-2-2 (VDE 0892 Part 2-2:1997-06).

## Part no.

**802187**, LON H122

**802188**, LON Y116

Dimensions and specifications may be changed without prior notice.

# BUS Cables

LON BUS Y118 + H118

**HELUKABEL®**

PVC + FRNC

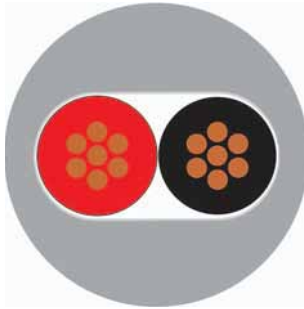

NEW

## Type

### Cable structure

Inner conductor diameter:  
Core insulation:  
Core colours:  
Stranding element:  
Separator:  
Shielding 1:  
Total shielding:  
Outer sheath material:  
Cable external diameter:  
Outer sheath colour:

## Mobile use

### 1x2xAWG 18/16

Copper, tinned (AWG 18/16)  
PVC  
rd, bk  
Double core  
Polyester foil over stranded bundle  
-  
-  
PVC  
app. 5,4 mm ± 0,3 mm  
Grey similar to RAL 7001

## Fixed installation, indoor

### 1x2xAWG 18/16

Copper, tinned (AWG 18/16)  
PE  
rd, bk  
Double core  
Polyester foil over stranded bundle  
-  
-  
FRNC  
app. 5,4 mm ± 0,3 mm  
Grey similar to RAL 7001

## Electrical data

Characteristic impedance:  
Conductor resistance, max.:  
Insulation resistance, min.:  
Loop resistance:  
Mutual capacitance:  
Nominal voltage:  
Test voltage:

85 Ohm ± 15 %  
14 Ohm/km  
0,02 GOhm x km  
28 Ohm/km max.  
10 nF/km nom.  
300 V  
1,5 kV

85 Ohm ± 15 %  
14 Ohm/km  
0,02 GOhm x km  
28 Ohm/km max.  
10 nF/km nom.  
300 V  
1,5 kV

## Technical data

Weight:  
bending radius, repeated:  
Operating temperature range min.:  
Operating temperature range max.:  
Caloric load, approx. value:  
Copper weight:  
Applicable standards:

app. 40 kg/km  
85 mm  
-20°C  
+80°C  
1,25 MJ/m  
20,00 kg/km  
Flame-retardant acc. to IEC 60332-1-2

app. 40 kg/km  
85 mm  
-20°C  
+70°C  
1,25 MJ/m  
20,00 kg/km  
Halogen-free acc. to 60754-2  
Flame-retardant acc. to IEC 60332-1-2

## Application

HELUKABEL® LON BUS Y118 PVC for mobile applications; version H118 FRNC for fixed installation. For both versions: use indoors acc. DIN EN 50090-2-2 (VDE 0892 Teil 2-2:1997-06).

## Part no.

**805660**, LON Y118

**805662**, LON H118

Dimensions and specifications may be changed without prior notice.

# BUS Cables

LON BUS H116

**HELUKABEL®**

FRNC

NEW

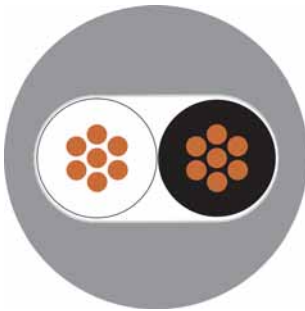

## Type

### Cable structure

Inner conductor diameter:  
Core insulation:  
Core colours:  
Stranding element:  
Separator:  
Shielding 1:  
Total shielding:  
Outer sheath material:  
Cable external diameter:  
Outer sheath colour:

## Fixed installation, indoor

### 1x2xAWG 16/19

Copper, tinned (AWG 16/19)  
PE  
wh, bk  
Double core  
Polyester foil over stranded bundle  
-  
-  
FRNC  
app. 7,0 mm ± 0,4 mm  
Grey similar to RAL 7001

## Electrical data

Characteristic impedance:  
Conductor resistance, max.:  
Insulation resistance, min.:  
Loop resistance:  
Mutual capacitance:  
Nominal voltage:  
Test voltage:

85 Ohm ± 15 %  
14 Ohm/km  
0,02 GOhm x km  
28 Ohm/km max.  
10 nF/km nom.  
300 V  
2 kV

## Technical data

Weight:  
bending radius, repeated:  
Operating temperature range min.:  
Operating temperature range max.:  
Caloric load, approx. value:  
Copper weight:  
Applicable standards:

app. 65 kg/km  
85 mm  
-20°C  
+70°C  
1,25 MJ/m  
30,00 kg/km  
Halogen-free acc. to 60754-2  
Flame-retardant acc. to IEC 60332-1-2

## Application

HELUKABEL® LON BUS H116 FRNC fixed installation indoor acc. DIN EN 50090-2-2 (VDE 0892 Teil 2-2:1997-06).

## Part no.

**805661**, LON H116

Dimensions and specifications may be changed without prior notice.



# BUS Cables

MOD-BUS fixed installed

**HELUKABEL®**

PVC + armoured

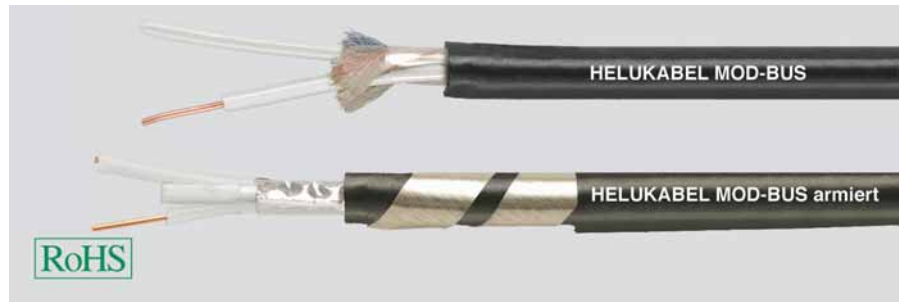

NEW

## Type Cable structure

Core insulation:  
Core colours:  
Stranding element:  
Separator:  
Shielding 1:  
Total shielding:  
Drain wire:  
Armouring:  
Outer sheath material:  
Cable external diameter:  
Outer sheath colour:

## Fixed installation, indoor 1x2x0,75-105 LI

PE  
wh, bu  
2 cores + 2 fillers stranded together  
Polyester foil over stranded bundle  
Al-Foil  
-  
yes  
-  
PVC  
app. 7,5 mm ± 0,3 mm  
Black similar to RAL 9005

## Fixed installation, indoor 1x2x0,75-105 LI armoured

PE  
wh, bu  
2 cores + 2 fillers stranded together  
Polyester foil over stranded bundle  
Al-Foil  
-  
yes  
other  
PVC  
app. 12,1 mm ± 0,5 mm  
Black similar to RAL 9005

## Electrical data

Characteristic impedance:  
Conductor resistance, max.:  
Insulation resistance, min.:  
Loop resistance:  
Nominal voltage:

105 Ohm ± 20 Ohm  
25 Ohm/km  
1 GOhm x km  
50 Ohm/km max.  
300 V

105 Ohm ± 20 Ohm  
25 Ohm/km  
1 GOhm x km  
50 Ohm/km max.  
300 V

## Technical data

Weight:  
bending radius, repeated:  
Operating temperature range min.:  
Operating temperature range max.:  
Copper weight:  
Applicable standards:

app. 70 kg/km  
80 mm  
-30°C  
+70°C  
45,00 kg/km  
Flame-retardant acc. to IEC 60332-3

app. 263 kg/km  
182 mm  
-30°C  
+70°C  
45,00 kg/km  
Flame-retardant acc. to IEC 60332-3

## Application

HELUKABEL® MOD-Bus PVC for standard application in this industry network.

## Part no.

**805698**, MOD-Bus Single Pair

**805697**, MOD-Bus Single Pair armoured

Dimensions and specifications may be changed without prior notice.

# BUS Cables

E-BUS / KNX fixed installed

 **HELUKABEL®**

PVC

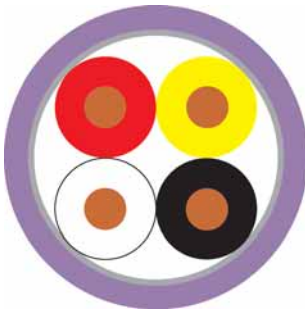

## Type Cable structure

Inner conductor:  
Core insulation:  
Core colours:  
Stranding element:  
Separator:  
Shielding 1:  
Total shielding:  
Drain wire:  
Outer sheath material:  
Cable external diameter:  
Outer sheath colour:

## 2-pairs 2x2x0.8 mm

Copper, bare  
PVC  
wh, ye, rd, bk  
Star quad  
Polyester foil over stranded bundle  
-  
Al-Foil  
yes  
PVC  
app. 6,6 mm ± 0,3 mm  
Blue Lilac similar to RAL 4005

## 2-pairs 2x2x0.8 mm

Copper, bare  
PVC  
wh, ye, rd, bk  
Star quad  
Polyester foil over stranded bundle  
-  
Al-Foil  
yes  
PVC  
app. 6,6 mm ± 0,3 mm  
Green similar to RAL 6010

## Electrical data

Characteristic impedance:  
Conductor resistance, max.:  
Insulation resistance, min.:  
Loop resistance:  
Mutual capacitance:  
Test voltage:

100 Ohm  
73,2 Ohm/km  
0,1 GOhm x km  
146 Ohm/km max.  
100 nF/km nom.  
4 kV

100 Ohm  
73,2 Ohm/km  
0,1 GOhm x km  
146 Ohm/km max.  
100 nF/km nom.  
4 kV

## Technical data

Weight:  
bending radius, repeated:  
Operating temperature range min.:  
Operating temperature range max.:  
Caloric load, approx. value:  
Copper weight:

app. 64 kg/km  
95 mm  
-30°C  
+70°C  
0,90 MJ/m  
25,00 kg/km

app. 64 kg/km  
95 mm  
-30°C  
+70°C  
0,90 MJ/m  
25,00 kg/km

## Norms

Applicable standards:

EIB/KNX standard  
Flame-retardant acc. to EN 50265-2-1

EIB/KNX standard  
Flame-retardant acc. to EN 50265-2-1

## Application

HELUKABEL® E-BUS EIB/KNX PVC for fixed installation. The E-Bus cable is intended for transmission of bus signals in intelligent building systems. The cables ensure perfect communication in compliance with EIB regulations. They can be installed over, in and under plaster, in conduits and cable channels, in dry, damp and wet rooms as well as outdoors - if protected from direct sunlight. Wiring together with high-power cables is possible without limitation. The EIB/KNX bus can be used to control lighting, blinds, heating, ventilation, indicator boards etc.

## Part no.

**81081**, E-BUS / KNX

**81663**, E-BUS / KNX

Dimensions and specifications may be changed without prior notice.

# BUS Cables

E-BUS / KNX fixed installed

**HELUKABEL®**

FRNC + PVC

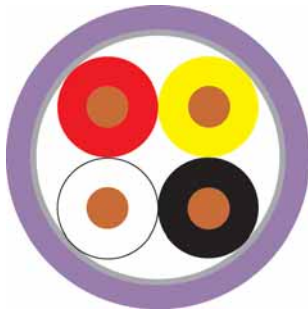

## Type Cable structure

Inner conductor:  
Core insulation:  
Core colours:  
Stranding element:  
Separator:  
Shielding 1:  
Total shielding:  
Drain wire:  
Outer sheath material:  
Cable external diameter:  
Outer sheath colour:

## 2-pairs 2x2x0.8 mm

Copper, bare  
PE  
wh, ye, rd, bk  
Star quad  
Polyester foil over stranded bundle  
-  
Al-Foil  
yes  
FRNC  
app. 6,6 mm ± 0,3 mm  
Blue Lilac similar to RAL 4005

## 4-pairs 4x2x0.8 mm

Copper, bare  
PVC  
wh, ye, rd, gn, bu, bn, wh, wh  
Double core  
Polyester foil over stranded bundle  
-  
Al-Foil  
yes  
PVC  
app. 8,2 mm ± 0,4 mm  
Blue Lilac similar to RAL 4005

## Electrical data

Characteristic impedance:  
Conductor resistance, max.:  
Insulation resistance, min.:  
Loop resistance:  
Mutual capacitance:  
Test voltage:

100 Ohm  
73,2 Ohm/km  
0,1 GOhm x km  
146 Ohm/km max.  
100 nF/km nom.  
4 kV

100 Ohm  
73,2 Ohm/km  
0,1 GOhm x km  
146 Ohm/km max.  
100 nF/km nom.  
4 kV

## Technical data

Weight:  
bending radius, repeated:  
Operating temperature range min.:  
Operating temperature range max.:  
Caloric load, approx. value:  
Copper weight:

app. 54 kg/km  
95 mm  
-30°C  
+70°C  
0,58 MJ/m  
25,00 kg/km

app. 92 kg/km  
120 mm  
-30°C  
+70°C  
1,37 MJ/m  
41,00 kg/km

## Norms

Applicable standards:

EIB/KNX standard  
Halogen-free acc. to 60754-2  
Flame-retardant acc. to EN 50265-2-1

EIB/KNX standard  
Flame-retardant acc. to EN 50265-2-1

## Application

HELUKABEL® E-BUS / KNX FRNC + PVC for fixed installation. If the application requires a halogen-free installation, the FRNC version is the right choice. The E-Bus cable is intended for transmission of bus signals in intelligent building systems. The cables ensure perfect communication in compliance with EIB/KNX regulations. They can be installed over, in and under plaster, in conduits and cable channels, in dry, damp and wet rooms as well as outdoors - if protected from direct sunlight. Wiring together with high-power cables is possible without limitation. The EIB/KNX bus can be used to control lighting, blinds, heating, ventilation, indicator boards etc.

## Part no.

**80826**, E-BUS / KNX

**81077**, E-BUS / KNX

Dimensions and specifications may be changed without prior notice.

# BUS Cables

E-BUS / KNX BURIAL fixed installed

 **HELUKABEL®**

PE, BURIAL

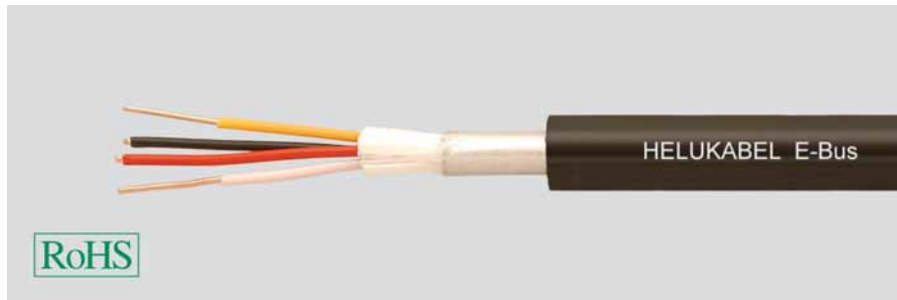

## Type

### Cable structure

Inner conductor:  
Core insulation:  
Core colours:  
Stranding element:  
Separator:  
Shielding 1:  
Total shielding:  
Outer sheath material:  
Cable external diameter:  
Outer sheath colour:

## Direct burial

### 2x2x0.8 mm

Copper, bare  
PE  
wh, ye, rd, bk  
Star quad  
Polyester foil over stranded bundle  
-  
Al-Foil  
PE  
app. 8,8 mm ± 0,3 mm  
Black similar to RAL 9005

## Electrical data

Characteristic impedance: 100 Ohm  
Conductor resistance, max.: 73,2 Ohm/km  
Insulation resistance, min.: 5 GOhm x km  
Loop resistance: 146 Ohm/km max.  
Mutual capacitance: 55 nF/km nom.  
Test voltage: 0,8 kV

## Technical data

Weight: app. 75 kg/km  
bending radius, repeated: 130 mm  
Operating temperature range min.: -20°C  
Operating temperature range max.: +70°C  
Caloric load, approx. value: 2,00 MJ/m  
Copper weight: 25,00 kg/km

## Norms

Applicable standards: EIB/KNX standard  
Halogen-free acc. to 60754-2

## Application

HELUKABEL® E-BUS / KNX ERD with PE jacket for fixed installation in the ground or outdoors and as a connection between buildings or to EIB/KNX components on the building. They can be installed over, in and under plaster, in conduits and cable channels, in dry, damp and wet rooms as well as outdoors - if protected from direct sunlight. Wiring together with high-power cables is possible without limitation. The EIB/KNX bus can be used to control lighting, blinds, heating, ventilation, indicator boards etc.

## Part no.

**802800**, E-BUS / KNX BURIAL

Dimensions and specifications may be changed without prior notice.

# BUS Cables

KH-BUS fixed installed

**HELUKABEL®**

PVC + FRNC



## Type Cable structure

Inner conductor, power core:  
Inner conductor, data core:  
Core insulation, power core:  
Core insulation, data core:  
Core colours, power core:  
Core colours, data core:  
Stranding element, data core:  
Shielding, data pair:  
Drain wire:  
Outer sheath material:  
Cable external diameter:  
Outer sheath colour:

## Electrical data

Insulation resistance, min.:  
Mutual capacitance:  
Test voltage:

## Technical data

Weight:  
bending radius, repeated:  
Operating temperature range min.:  
Operating temperature range max.:  
Caloric load, approx. value:  
Copper weight:

## Application

HELUKABEL® KH-BUS PVC + FRNC for fixed installation of patient calling systems. Simple and fast installation is an important factor there. For this reason, a 6-conductor hybrid cable is used to connect the individual components of the calling system. This cable is used for the power supply, speech and data transmission. The FRNC version is the right choice when a halogen-free installation is required.

## Part no.

Dimensions and specifications may be changed without prior notice.

## Hospital-Bus 2x1.5mm<sup>2</sup> (stranded) + 2x2x0.60 mm (solid)

Copper, bare  
Copper, tinned  
PVC  
PE  
rd, bu  
gn/ye, gy/pk  
Double core  
PP foil + aluminium-lined foil + PP foil  
yes  
PVC  
app. 8,0 mm ± 0,3 mm  
Green similar to RAL 6001

0,02 GOhm x km  
70 nF/km nom.  
2 kV

app. 90 kg/km  
120 mm  
-40°C  
+80°C  
1,01 MJ/m  
53,00 kg/km

## Hospital-Bus 2x1.5mm<sup>2</sup> (stranded) + 2x2x0.60 mm (solid)

Copper, bare  
Copper, tinned  
PE  
PE  
rd, bu  
gn/ye, gy/pk  
Double core  
PP foil + aluminium-lined foil + PP foil  
yes  
FRNC  
app. 8,0 mm ± 0,3 mm  
Green similar to RAL 6001

0,02 GOhm x km  
70 nF/km nom.  
2 kV

app. 93 kg/km  
120 mm  
-25°C  
+80°C  
0,86 MJ/m  
53,00 kg/km

**81085**, KH-BUS

**81447**, KH-BUS

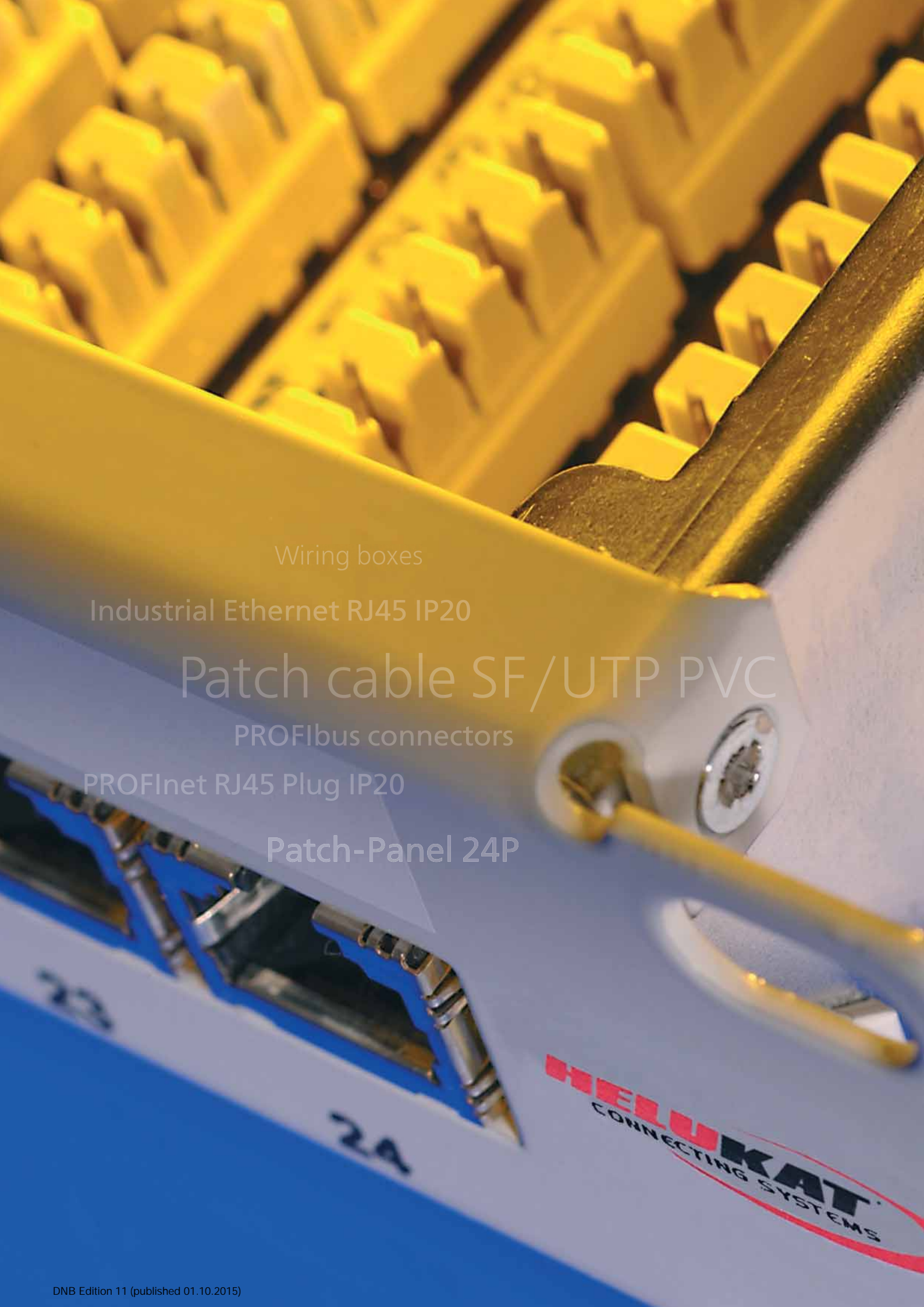

Wiring boxes

Industrial Ethernet RJ45 IP20

Patch cable SF/UTP PVC

PROFibus connectors

PROFINet RJ45 Plug IP20

Patch-Panel 24P

**HELUKAT**  
CONNECTING SYSTEMS

# ■ COPPER DATA CONNECTION TECHNICS

Designation	Page
<b>Connection Technic - Office</b>	
Complete system solutions	230
Certificates	231
Modular connector Systems RJ45	232
Patch panel screened 24P Cat.6a, 500MHz (10 GBit)	235
Patch panel screened 24P Cat.6 /Class E	236
Patch panel unscreened 24P Cat.6 /Class E	237
Patch panel screened 24P Cat.5e/ Class D	238
Patch panel ISDN Cat.3 25-port	239
Patch panel ISDN Cat.3 50-port	240
Wiring boxes UP screened 2P Cat.6a, 500 MHz (10 GBit)	241
Wiring boxes UP screened 2P Cat.6/Class E	242
Wiring boxes unscreened 2P Cat.6/Class E	243
Wiring boxes UP screened Cat.5e/ Class D	244
Patch cable S/FTP halogenfree, Cat.6a 500 MHz (10GBit)	245
Patch cable U/UTP halogenfree, Cat.6a 500 MHz (10GBit)	246
Patch cable S/FTP halogenfree, Cat.6	247
Patch cable U/UTP PVC, Cat.6	249
Patch cable SF/UTP PVC Cat.5e	251
Patch cable U/UTP PVC, Cat.5e	253
General accessories	254
Rubber cable reel with HELUKAT® copper data cable	255
<b>Connection Technic - Industry</b>	
Copper connectors overview	258
DIN rail distribution panels copper, modular	260
Top-hat rail installation modul 2xRJ45/LSA, Cat.6	261
Industrial Ethernet RJ45 outlets IP67	262
Industrial Ethernet M12 (D+B coded) outlets IP67	263
Top-hat rail installation data outlets Cat.6 / Class E	264
Patch Cable RJ45 HARTING HAN® 3A IP67, PROFINet A fixed installation	265
Patch Cable RJ45 HARTING Push-Pull plastic IP65/67, PROFINet A fixed installation	266
Patch Cable RJ45 HARTING HAN® 3A IP67, PROFINet C drag chain	267
Patch Cable RJ45 HARTING Push-Pull IP67, PROFINet C drag chain	268
Patch Cable RJ45 PHOENIX Variosub IP67, LAN-Industry drag chain	269
Adapter Cable RJ45 HARTING IP20 to HAN® 3A IP67, PROFINet A fixed installation	270
Patch Cable RJ45 HARTING Industrial IP20, PROFINet A fixed installation	271
Patch Cable RJ45 HARTING Industrial IP20 angled left, PROFINet A fixed installation	272
Patch Cable RJ45 HARTING Industrial IP20, LAN-Industry flexible	273
Patch Cable RJ45 8P HARTING INDUSTRIAL IP20, LAN-Industry	274
Patch Cable RJ45 HARTING Industrial IP20, PROFINet C drag chain	275
Patch Cable RJ45 HARTING IP20, LAN-Industry drag chain	276
Patch Cable RJ45 LAN-Industry PHOENIX Variosub IP20, drag chain	277
Patch Cable USB 2.0 A, industrial USB – drag chain	278
Patch Cable M12 LAN-Industry IP67, drag chain	279
Patch Cable M12W LAN-Industry IP67, drag chain	280
Patch Cable M12 for Profibus RS 485, drag chain	281
Patch Cable M12W for Profibus RS 485, drag chain	282
RJ45 industrial plugs IP20 and IP65/67	283
RJ45 industrial plugs IP20 and IP65/67	284
PROFIBUS Sub-D connectors	285
PROFIBUS Adaptor Sub-D/M12 with and without PG	286

# ■ COMPLETE SYSTEM SOLUTIONS



As a result of the drastic growth of the volume of data handled by data and network systems together with subsequently lower tolerance deviations allowed in relation to standard specifications, ensuring the optimum level of component integration and efficiency is sure to be a vital factor in the creation of successful systems in the future.

In recent years, **HELUKAT®** has earned an excellent reputation in the area of structured copper data wiring. Superior quality combined with expert technical assistance and prompt delivery to customers is what makes **HELUKABEL®** the brand of choice. With **HELUKAT CONNECTING SYSTEMS®**, we have come full

circle to provide you with a complete wiring system comprising everything from the installation cable, patch panels and RJ45 sockets all the way to patch cables and data cabinets. To provide customers and users with a sufficient level of transparency, components have been subjected to a non-biased examination carried out according to the channel link. The GHMT company has certified our products for category 6 and classes D, E and Ea.

Simply specify the network structures you need, and let the superior quality and reliability of **HELUKAT CONNECTING SYSTEMS®** do the rest.

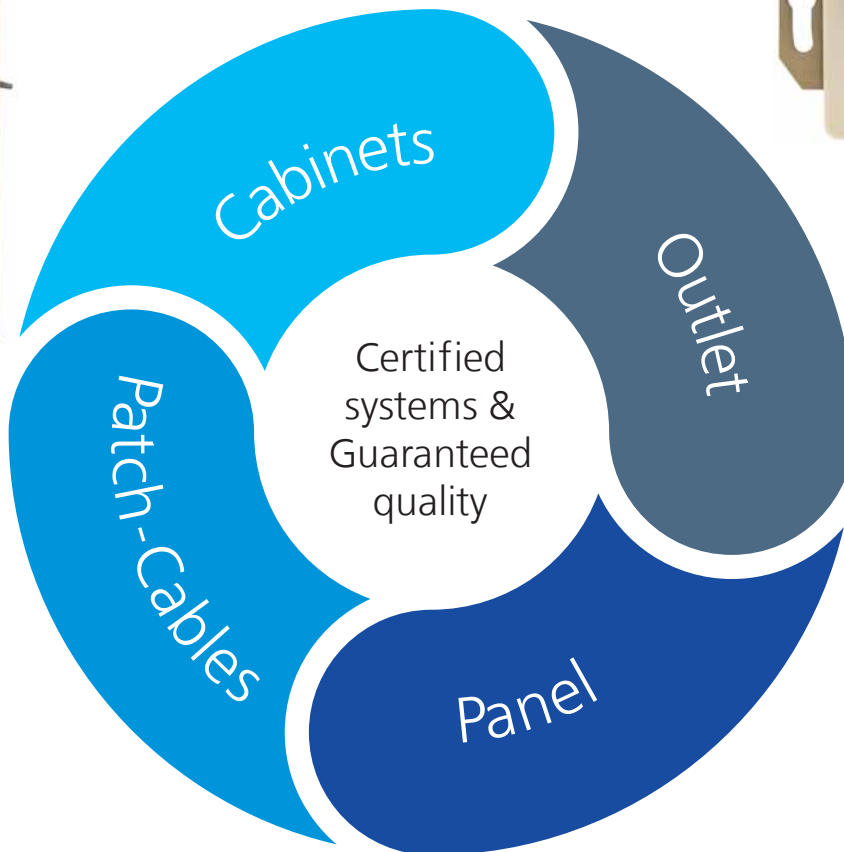



## Certificate

No. z2912a-12-E

**Customer:**  
HELUKABEL GmbH  
Dieselstraße 8-12  
D-71282 Hemmingen

**Test sample(s):**

- Connector:  
**HELUKAT CONNECTING SYSTEMS®**  
RJ Modular Jack Cat.6EA  
Part No.: 802377
- Data Cable:  
**HELUKAT® 600 S-STP (4x2xAWG23/1) FRNC**  
Part No.: 803898, 803897, 80810, 81446

**Applied standard(s):**

- ISO/IEC 11801 AMD 2 (2010-04)

**Results:**  
Up to a bandwidth of **500 MHz** the sample meets the **Class E<sub>A</sub>** limits of the specified standards and regulations.

---

**2-Connector Permanent Link, Class E<sub>A</sub>**

The test results which were determined in the course of the measurement refer to the submitted specimen. Any future technical modifications of the verified Products are subject to the responsibility of the manufacturer.  
This Certificate refers to the comprehensive test report, no. P2912a-12-E, dated April 10<sup>th</sup>, 2012 and shall only be applicable in conjunction with the test report.

Bexbach, April 10<sup>th</sup>, 2012

Dirk Wilhelm, engineer  
(Chairman of the Managing Board)

GHMT AG  
In der Kolling 13  
D-66450 Bexbach  
Phone: +49 (0) 68 26 / 92 28 - 0  
Fax: +49 (0) 68 26 / 92 28 - 99  
Email: info@ghmt.de

## Zertifikat

**Auftraggeber:** HELUKABEL GmbH  
Dieselstraße 8-12  
D-71282 Hemmingen

**Prüfung:** Installationskabel: **Helukat 600 4x2xAWG23 S-STP**  
90m Art.-Nr.: 80810  
Anschlussdose: **Helukat Connecting Systems Datendose UP**  
Art.-Nr.: 82851  
Verteilerfeld: **Helukat Connecting Systems Patch Panel 24 Port**  
Art.-Nr.: 82848

**Bewertungsstandards:** ISO/IEC 11801: 2002  
Information technology – Cabling for customer premises,  
EN 50173-1: 2002  
Information technology – Generic cabling systems –  
Part 1: General requirements and office areas

**Resultat:** Der Prüfling hält bei den im Prüfbericht genannten Prüfparametern die Grenzwerte der besagten Vorgabedokumente **nach Klasse E im Permanent-Link von 90m ein.**

Die bei der Prüfung ermittelten Ergebnisse beziehen sich auf den beschriebenen und vom Auftraggeber vorgelegten Prüfling. Zukünftige technische Änderungen der Datenkabel und Steckverbinder unterliegen dem Verantwortungsbereich der Hersteller.

Dieses Zertifikat verweist auf den ausführlichen Prüfbericht **PB-Nr. P1444b-05-D vom 14. Juli 2005** und ist nur in Verbindung mit diesem gültig.

Bexbach, 14. Juli 2005

Dipl.-Ing. Dirk Wilhelm  
(Vorstandsvorsitzender)

GHMT AG  
In der Kolling 13  
D-66450 Bexbach  
Tel.: +49 (0) 68 26 / 92 28 - 0  
Fax: +49 (0) 68 26 / 92 28 - 99  
E-Mail: info@ghmt.de  
http://www.ghmt.de

GHMT Aktiengesellschaft

## Certificate

No. z2913a-12-E

**Customer:**  
HELUKABEL GmbH  
Dieselstraße 8-12  
D-71282 Hemmingen

**Test sample(s):**

- Connector:  
**HELUKAT CONNECTING SYSTEMS®**  
RJ Modular Jack Kat.6  
Part No.: 802916
- Data Cable:  
**HELUKAT® 600 S-STP (4x2xAWG23/1) FRNC**  
Part No.: 803898, 803897, 80810, 81446

**Applied standard(s):**

- ISO/IEC 11801 AMD 2 (2010-04)

**Results:**  
Up to a bandwidth of **250 MHz** the sample meets the **Class E** limits of the specified standards and regulations.

---

**2-Connector Permanent Link, Class E**

The test results which were determined in the course of the measurement refer to the submitted specimen. Any future technical modifications of the verified Products are subject to the responsibility of the manufacturer.  
This Certificate refers to the comprehensive test report, no. P2913a-12-E, dated April 10<sup>th</sup>, 2012 and shall only be applicable in conjunction with the test report.

Bexbach, April 10<sup>th</sup>, 2012

Dirk Wilhelm, engineer  
(Chairman of the Managing Board)

GHMT AG  
In der Kolling 13  
D-66450 Bexbach  
Phone: +49 (0) 68 26 / 92 28 - 0  
Fax: +49 (0) 68 26 / 92 28 - 99  
Email: info@ghmt.de

## Certificate

**Customer:** HELUKABEL® GmbH  
Dieselstr. 8-12  
D-71282 Hemmingen

**Description:** Modul: **HELUKAT CONNECTING SYSTEMS®**  
Modulsystem Keystone Cat. 6EA 500 MHz  
Part-No.: 802377

Connector: **HELUKAT CONNECTING SYSTEMS®**  
Connector Cat. 7 to connect Data Cables

Data Cable: **HELUKAT® 600MHz**  
Data Cable S-STP 4x2xAWG23/1 FRNC 600MHz  
Part-No.: 80810

Patchcord: **HELUKAT CONNECTING SYSTEMS®**  
S-STP 4x2xAWG26/7 FRNC 600MHz  
RJ45 Category 6 (Stewart 39), Length 5,0m

**Applied standards:** ISO/IEC 11801 Amendment 1: 2008-04  
Information technology – Generic cabling for customer premises  
ISO/IEC TR 24750 Assessment and mitigation of installed balanced cabling channels in order to support 10GBASE-T  
TIA/EIA-568-B.2-10  
Transmission performance specifications for 4-pair 100 Ω augmented category 6 cabling  
ANSI/TIA TSB-155  
Additional guidelines for 4-pair 100 Ω category 6 cabling for 10GBASE-T  
IEEE 802.3an TM-2006  
Local and Metropolitan Area Networks (10 GBASE-T)

**Results:** Up to a bandwidth of **Augmented Class E (500MHz)** the sample, a **4-Connector-Channel**, meet the limits of the specified standards and regulations.

The test results which were determined in the course of the measurement refer to the submitted specimen. Any future technical modifications of the data cables or connectors are subject to the responsibility of the manufacturer.  
This Certificate refers to the comprehensive test report, no. P1919b-08-E, from July 31<sup>st</sup> 2008 and shall only be applicable in conjunction with the test report.

Bexbach, July 31<sup>st</sup> 2008

Dirk Wilhelm, engineer  
(Chairman of the Managing Board)

GHMT AG  
In der Kolling 13  
D-66450 Bexbach  
Phone: +49 (0) 68 26 / 92 28 - 0  
Fax: +49 (0) 68 26 / 92 28 - 99  
E-Mail: info@ghmt.de  
http://www.ghmt.de

GHMT Aktiengesellschaft

# MODULAR-SYSTEM RJ45



## Jack/Keystone

Category:  
Plug type:  
Screening:  
Colour:  
Part no:  
Packing unit:  
Dust Protection:

7 <sub>A</sub>	6 <sub>A</sub>	6	6	6	5e
AMP-Twist	RJ45 8(8)				
yes			no		
metallic			black	white	
<b>805586</b>	<b>802377</b>	<b>802916</b>	<b>804691</b>	<b>805044</b>	<b>804645</b>
10	12				
yes	yes	no	yes	yes	no



## Panel

Version:  
Module type:  
Colour:  
Max. number of modules:  
Part no:  
Packing unit:  
Dust Protection:

Modular Panel		
AMP-Twist	RJ45	
black	grey	black
24		
<b>805587</b>	<b>802376</b>	<b>805429</b>
1		
from Keystone	optional see Accessories	



## Outlet

Version:  
Module type:  
Colour:  
Max. number of modules:  
Part no:  
Packing unit:  
Dust Protection:

Support for module			
RJ45			
white			Metall
3	2	1	2
<b>802986</b>	<b>802378</b>	<b>802985</b>	<b>804763</b>
4			1
optional see Accessories			no



## Plug

Category:

Version:

Type of conductor:

Part no:

Packing unit:

7 <sub>A</sub>	
AMP-Twist Plu	
Stranded conductor	Solid conductor
<b>805588</b>	<b>805589</b>
10	

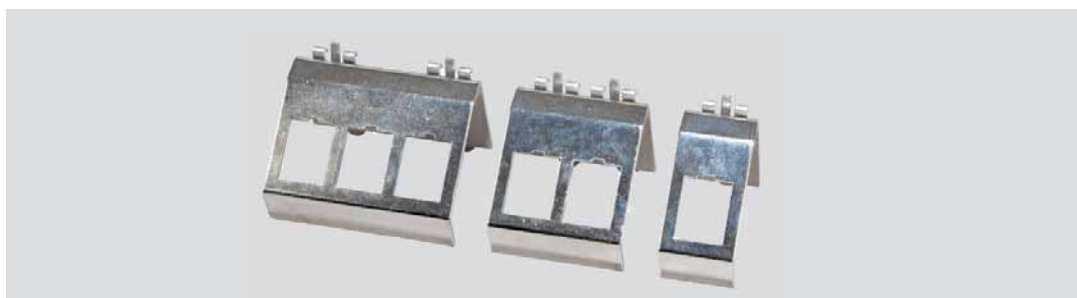

## DIN rail module

Version:

Max. number of modules:

Colour:

Part no:

Packing unit:

DIN rail module for Jack/Keystone		
1	2	3
metallic		
<b>805403</b>	<b>805404</b>	<b>805405</b>
1		



## Accessories

Part no:

Description:

Colour:

805381	802988	802987	802990	804286
Tools for AMP-Twist Jack	Floor tank frame set 3x3 Port empty	Floor tank frame set 2x3 Port empty	Dust Protection forKeystone-system Outlet and Panels	
metallic	black		white	black

### Norms and standards

Kat. 5, Kat. 5e, Kat. 6, Kat. 6<sub>A</sub>, Kat. 7<sub>A</sub> according to the specifications of each product. More informations can be found at our data sheets.

### Application

As floor distributor in applications of digital and analog image, data and voice transmission.

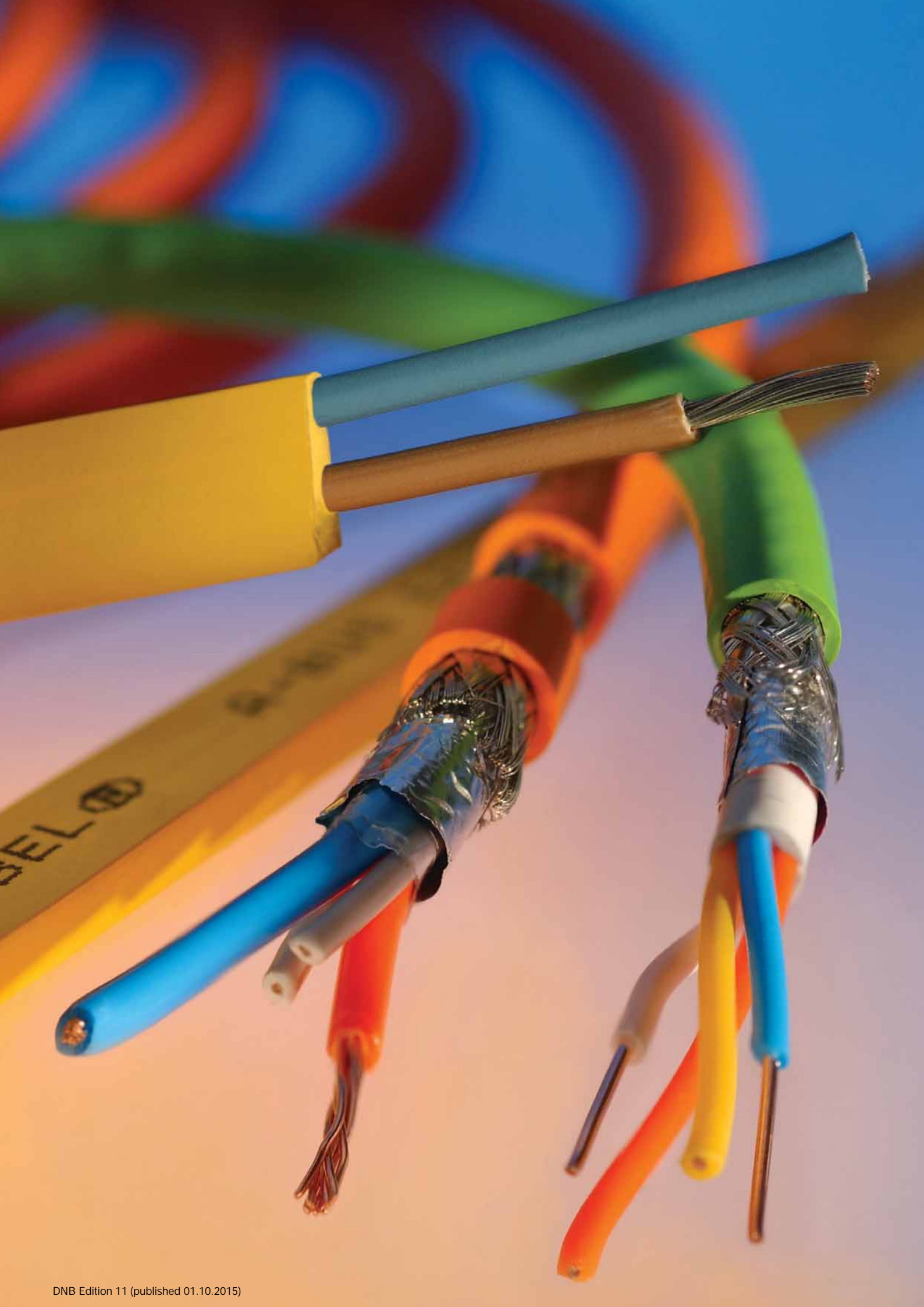

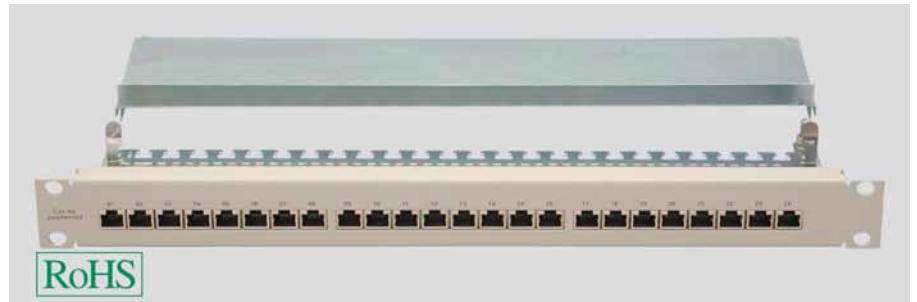

## Type

### Configuration

Housing material:	Steel plate, solid
Colour:	Grey similar to RAL 7035
Board:	3x8 mother board, number-coded
Push-on connector type:	RJ45(8/8)
Number of bushes:	24
Type of screen:	Overall screen
Screen removal:	metalized cable straps
Strain relief:	by means of cable straps
Cover lock:	Quick-action snap cover

### Connecting system

Connection type:	LSA plus - insulation piercing connections
Suitable for cable diameter:	0.4 - 0.64mm (AWG 26 - 22)
Insulation diameter, min.:	0,7 - 1,6 mm (PE)

### Assignment type

EIA/TIA 568 A + EIA/TIA 568 B

### Dimension

Width:	483 mm
Depth:	125 mm
Number of height modules (HM):	1
Fastening dimensions:	19"

### Norms and standards

HELUKAT® CONNECTING SYSTEMS® system component up to 500 MHz (10 GBit Ethernet) in accordance with category 6a EIA/TIA 568-B.2-10, IEEE 802.3an TM-2006, ISO/IEC 11801 (Amendment 1 JTC 1/SC N1255), ISO/IEC TR-24750 and EN 55022 (EMV).

### Application

As floor distributor in applications of digital and analog image, data and voice transmission.

### Part no.

**802024**

Dimensions and specifications may be changed without prior notice.

### Packing unit

**1**

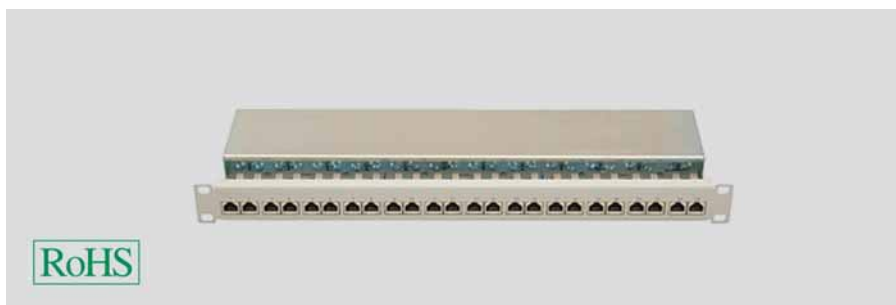

## Type

### Configuration

Housing material:	Steel plate, solid
Colour:	Grey similar to RAL 7035
Board:	3x8 mother board, colour and number-coded
Push-on connector type:	RJ45(8/8)
Number of bushes:	24
Type of screen:	Overall screen
Screen removal:	via continuous screening tape
Strain relief:	via pre-installed cable clips
Cover lock:	Quick-action snap cover

### Connecting system

Connection type:	LSA plus - insulation piercing connections
Suitable for cable diameter:	0.4 - 0.64mm (AWG 26 - 22)
Insulation diameter, min.:	0,7 - 1,7 mm (PE)

### Assignment type

EIA/TIA 568 A + EIA/TIA 568 B

### Dimension

Width:	483 mm
Depth:	148 mm
Number of height modules (HM):	1
Fastening dimensions:	19"

### Norms and standards

HELUKAT® CONNECTING SYSTEMS® system component up to 250 MHz in the permanent link of category 6 / Class E in accordance with ISO 11801, 2nd edition, EN 50173, 2nd edition, EIA/TIA 568 B, and EN 55022 (EMC).

### Application

As floor distributor in applications of digital and analog image, data and voice transmission.

### Part no.

**82848**

Dimensions and specifications may be changed without prior notice.

### Packing unit

**1**

# Patch-Panels RJ45 unscreened



Category 6/ Class E



## Type

### Configuration

Housing material:	Steel plate, solid
Colour:	Black similar to RAL 9005
Board:	3x8 mother board, colour and number-coded
Push-on connector type:	RJ45(8/8)
Number of bushes:	24
Type of screen:	no
Strain relief:	by means of cable straps

### Connecting system

Connection type:	LSA plus - insulation piercing connections
Suitable for cable diameter:	0.4 - 0.64mm (AWG 26 - 22)
Insulation diameter, min.:	0,7 - 1,7 mm (PE)

### Assignment type

EIA/TIA 568 A + EIA/TIA 568 B

### Dimension

Width:	440 mm
Depth:	110 mm
Number of height modules (HM):	1
Fastening dimensions:	19"

### Norms and standards

HELUKAT® CONNECTING SYSTEMS® unscreened system component up to 250 MHz of category 6 / Class E in accordance with ISO 11801, EN 50173.

### Application

As floor distributor in applications of digital and analog image, data and voice transmission.

### Part no.

**802908**

Dimensions and specifications may be changed without prior notice.

### Packing unit

**1**



## Type

### Configuration

Housing material:	Steel plate, solid
Colour:	Grey similar to RAL 7035
Board:	3x8 mother board, colour and number-coded
Push-on connector type:	RJ45(8/8)
Number of bushes:	24
Type of screen:	Overall screen
Screen removal:	via continuous screening tape
Strain relief:	via pre-installed cable clips
Cover lock:	Quick-action twist lock

## Patch panel cat. 5e / class D 24P

### Connecting system

Connection type:	LSA plus - insulation piercing connections
Suitable for cable diameter:	0.4 - 0.64mm (AWG 26 - 22)
Insulation diameter, min.:	0,7 - 1,7 mm (PE)

### Assignment type

EIA/TIA 568 A + EIA/TIA 568 B

### Dimension

Width:	483 mm
Depth:	148 mm
Number of height modules (HM):	1
Fastening dimensions:	19"

### Norms and standards

HELUKAT® CONNECTING SYSTEMS® system component up to 100 MHz in category 5(e) / Class D in accordance with ISO 11801, 2nd edition, EN 50173, 2nd edition, EIA/TIA 568 B, and EN 55022 (EMC)

### Application

As floor distributor in applications of digital and analog image, data and voice transmission.

### Part no.

**82010**

Dimensions and specifications may be changed without prior notice.

### Packing unit

**1**



# Patch-Panels RJ45 unscreened



Category 3

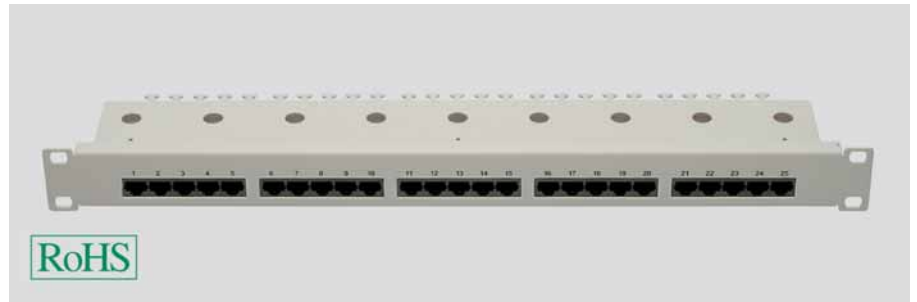

## Type

### Configuration

Housing material:	Steel plate, solid
Colour:	Grey similar to RAL 7035
Board:	5x 5 mother board, number-coded
Push-on connector type:	RJ45(8/4)
Number of bushes:	25
Type of screen:	no
Screen removal:	no
Strain relief:	by means of cable straps

### Connecting system

Connection type:	LSA plus - insulation piercing connections
Suitable for cable diameter:	0.4 - 0.64mm (AWG 26 - 22)

### Assignment type

acc. ISO/IEC 11801 and EN 50173

### Dimension

Width:	483 mm
Depth:	118 mm
Number of height modules (HM):	1
Fastening dimensions:	19"

### Norms and standards

HELUKAT® CONNECTING SYSTEMS® category 3 system component according ISO/IEC 11801 and EN 50173.

### Application

As floor distributor in applications of voice transmission (ISDN). Deliverable as 25-port or 50-port version.

### Part no.

**81302**

Dimensions and specifications may be changed without prior notice.

### Packing unit

**1**

# Patch-Panels RJ45 unscreened



Category 3



## Type

### Configuration

Housing material:	Steel plate, solid
Colour:	Grey similar to RAL 7035
Board:	1x 25 mother board (double), number-coded
Push-on connector type:	RJ45(8/4)
Number of bushes:	50
Type of screen:	no
Screen removal:	no
Strain relief:	by means of cable straps

### Connecting system

Connection type:	LSA plus - insulation piercing connections
Suitable for cable diameter:	0.4 - 0.64mm (AWG 26 - 22)

### Assignment type

acc. ISO/IEC 11801 and EN 50173

### Dimension

Width:	483 mm
Depth:	118 mm
Number of height modules (HM):	1
Fastening dimensions:	19"

### Norms and standards

HELUKAT® CONNECTING SYSTEMS® category 3 system component according ISO/IEC 11801 and EN 50173.

### Application

As floor distributor in applications of voice transmission (ISDN). Deliverable as 25-port or 50-port version.

### Part no.

**801159**

Dimensions and specifications may be changed without prior notice.

### Packing unit

**1**



## Type

**RJ-45 UP socket 2P cat. 6EA  
500MHz vertical**

**RJ-45 UP socket 2P cat. 6a  
500MHz horizontal**

## Configuration

Housing material:  
Colour:  
Board:  
Push-on connector type:  
Outlet direction:  
Number of bushes:  
Type of screen:  
Strain relief:  
Cable inlet:

Die-cast, shielded  
Pure White similar to RAL 9010  
1x2  
RJ45(8/8)  
45 degrees  
2  
Overall screen  
via pre-installed cable clips  
vertical

Die-cast, shielded  
Pure White similar to RAL 9010  
1x2  
RJ45(8/8)  
45 degrees  
2  
Overall screen  
via pre-installed cable clips  
horizontal

## Connecting system

Connection type:  
Suitable for cable diameter:  
Insulation diameter, min.:

LSA plus - insulation piercing connections  
0,4 - 0,64mm (AWG 26 - 22)  
0,7 - 1,6 mm (PE)

LSA plus - insulation piercing connections  
0,4 - 0,64mm (AWG 26 - 22)  
0,7 - 1,6 mm (PE)

## Assignment type

EIA/TIA 568 A + EIA/TIA 568 B

EIA/TIA 568 A + EIA/TIA 568 B

## Dimension

Dimensions of central plate:  
Installation dimensions:

50 x 50mm  
50 x 50 x 32mm

50 x 50mm  
50 x 50 x 32mm

## Norms and standards

HELUKAT® CONNECTING SYSTEMS® system component up to 500 MHz (10 GBit Ethernet) in accordance with category 6a EIA/TIA 568-B.2-10, IEEE 802.3an TM-2006, ISO/IEC 11801 (Amendment 1 JTC 1/SC N1255), ISO/IEC TR-24750 and EN 55022 (EMV).

## Application

As workstation interface in applications of digital and analog image, data and voice transmission. Available as in-wall version (channel) and top-mount version (wall).

## Part no.

**802025**

**802034**

Dimensions and specifications may be changed without prior notice.

## Packing unit

**10**

**10**



## Type

**RJ-45 UP socket class E 2P horizontal**

**RJ-45 UP socket class E 2P vertical**

## Configuration

Housing material:  
Colour:  
Board:  
Push-on connector type:  
Outlet direction:  
Number of bushes:  
Type of screen:  
Strain relief:  
Cable inlet:

Die-cast, shielded  
Pure White similar to RAL 9010  
1x2  
RJ45(8/8)  
45 degrees  
2  
Overall screen  
via pre-installed cable clips  
horizontal

Plastic, shielded  
Pure White similar to RAL 9010  
1x2  
RJ45(8/8)  
45 degrees  
2  
Overall screen  
via pre-installed cable clips  
vertical

## Connecting system

Connection type:  
Suitable for cable diameter:  
Insulation diameter, min.:

LSA plus - insulation piercing connections  
0,4 - 0,64mm (AWG 26 - 22)  
0,7 - 1,6 mm (PE)

LSA plus - insulation piercing connections  
0,4 - 0,64mm (AWG 26 - 22)  
0,7 - 1,6 mm (PE)

## Assignment type

EIA/TIA 568 A + EIA/TIA 568 B

EIA/TIA 568 A + EIA/TIA 568 B

## Dimension

Dimensions of central plate:  
Installation dimensions:

50 x 50mm  
51 x 51 x 29mm

50 x 50mm  
51 x 51 x 29mm

## Norms and standards

HELUKAT® system component up to 250 MHz in the permanent link of category 6 / Class E in accordance with ISO 11801, 2nd edition, EN 50173, 2nd edition, EIA/TIA 568 B, and EN 55022 (EMC).

## Application

As workstation interface in applications of digital and analog image, data and voice transmission. Available as in-wall version (channel) and top-mount version (possible with an extra frame).

## Part no.

**82847**

**82851**

Dimensions and specifications may be changed without prior notice.

## Packing unit

**10**

**10**

# Outlets RJ45 unscreened



Category 6/ Class E



## Type

**RJ-45 UP socket unscreened class E 2P vertical**

**RJ-45 UP socket unscreened class E 2P horizontal**

## Configuration

Housing material:  
Colour:  
Board:  
Push-on connector type:  
Outlet direction:  
Number of bushes:  
Type of screen:  
Strain relief:  
Cable inlet:

Plastic  
Pure White similar to RAL 9010  
1x2  
RJ45(8/8)  
45 degrees  
2  
no  
via pre-installed cable clips  
vertical

Plastic  
Pure White similar to RAL 9010  
1x2  
RJ45(8/8)  
45 degrees  
2  
no  
via pre-installed cable clips  
horizontal

## Connecting system

Connection type:  
Suitable for cable diameter:  
Insulation diameter, min.:

LSA plus - insulation piercing connections  
0,4 - 0,64mm (AWG 26 - 22)  
0,7 - 1,6 mm (PE)

LSA plus - insulation piercing connections  
0,4 - 0,64mm (AWG 26 - 22)  
0,7 - 1,6 mm (PE)

## Assignment type

EIA/TIA 568 A + EIA/TIA 568 B

EIA/TIA 568 A + EIA/TIA 568 B

## Dimension

## Norms and standards

HELUKAT® system component unscreened up to 250 MHz of category 6 or Class E in accordance with ISO 11801, EN 50173, ANSI/TIA/EIA 568 B2-1.

## Application

As workstation interface in applications of digital and analog image, data and voice transmission. Available as in-wall version (channel) and top-mount version (possible with an extra frame).

## Part no.

**802909**

**803033**

Dimensions and specifications may be changed without prior notice.

## Packing unit

**10**

**10**



## Type

**RJ-45 UP socket cat. 5e 2P horizontal**

**RJ-45 UP socket cat. 5e 2P vertical**

## Configuration

Housing material: Die-cast, shielded  
 Colour: Pure White similar to RAL 9010  
 Board: 1x2  
 Push-on connector type: RJ45(8/8)  
 Outlet direction: 45 degrees  
 Number of bushes: 2  
 Type of screen: Overall screen  
 Strain relief: via pre-installed cable clips  
 Cable inlet: horizontal

Housing material: Die-cast, shielded  
 Colour: Pure White similar to RAL 9010  
 Board: 1x2  
 Push-on connector type: RJ45(8/8)  
 Outlet direction: 45 degrees  
 Number of bushes: 2  
 Type of screen: Overall screen  
 Strain relief: via pre-installed cable clips  
 Cable inlet: vertical

## Connecting system

Connection type: LSA plus - insulation piercing connections  
 Suitable for cable diameter: 0,4 - 0,64mm (AWG 26 - 22)  
 Insulation diameter, min.: 0,7 - 1,1mm (PE)

Connection type: LSA plus - insulation piercing connections  
 Suitable for cable diameter: 0,4 - 0,64mm (AWG 26 - 22)  
 Insulation diameter, min.: 0,7 - 1,1mm (PE)

## Assignment type

EIA/TIA 568 A + EIA/TIA 568 B

EIA/TIA 568 A + EIA/TIA 568 B

## Dimension

Dimensions of central plate: 50 x 50mm  
 Installation dimensions: 51 x 51 x 29mm

Dimensions of central plate: 50 x 50mm  
 Installation dimensions: 51 x 51 x 29mm

## Norms and standards

HELUKAT® CONNECTING SYSTEMS® system component up to 100 MHz in category 5(e) / Class D in accordance with ISO 11801, 2nd edition, EN 50173, 2nd edition, EIA/TIA 568 B, and EN 55022 (EMC)

## Application

As workstation interface in applications of digital and analog image, data and voice transmission. Available as in-wall version (channel) and top-mount version (wall).

## Part no.

**82008**

**82853**

Dimensions and specifications may be changed without prior notice.

## Packing unit

**10**

**10**



## Type

### Cable

Designation:  
Sheath material:  
Frequency:

## Patch cable S/FTP halogenfree, Cat.6a 500 MHz (10GBit)

S/FTP 4x2xAWG 26/7 LSZH  
LSZH  
up to 500 MHz

### Plug

Push-on connector type 1:  
Push-on connector type 2:  
Pin assignment:

RJ45 8(8)  
RJ45 8(8)  
1:1 acc. to TIA/EIA 568 B

### Flame proof

acc. to IEC 60332-1-2

### Norms and standards

HELUKAT® CONNECTING SYSTEMS® system components up to 500 MHz (10GBit) of category 6a / Class E in accordance with ISO 11801, 2nd edition, EN 50173, 2nd edition, and EIA/TIA 568 C-2.

### Preferred types

Part no.	Sheath colour	Length in metres	Unit
<b>802380</b>	grey	1,0	10
<b>802381</b>	grey	2,0	10
<b>802382</b>	grey	3,0	10
<b>802383</b>	grey	5,0	10
<b>802384</b>	grey	7,5	10
<b>802385</b>	grey	10,0	10
<b>804287</b>	grey	15,0	10

Dimensions and specifications may be changed without prior notice.

### Options

Naturally, we also offer other lengths and colors on request.



## Type

### Cable

Designation:  
Sheath material:  
Frequency:

## Patch cable U/UTP halogenfree, Cat.6a 500 MHz (10GBit)

U/UTP 4x2xAWG26/7 LSZH  
LSZH  
up to 500 MHz

### Plug

Push-on connector type 1:  
Push-on connector type 2:  
Pin assignment:

RJ45 8(8)  
RJ45 8(8)  
1:1 acc. to TIA/EIA 568 B

### Flame proof

acc. to IEC 60332-1-2

### Norms and standards

HELUKAT® CONNECTING SYSTEMS® system components up to 500 MHz (10GBit) of category 6a / Class E in accordance with ISO 11801, 2nd edition, EN 50173, 2nd edition, and EIA/TIA 568 C-2.

### Preferred types

Part no.	Sheath colour	Length in metres	Unit
<b>804972</b>	grey	1,0	10
<b>804973</b>	grey	2,0	10
<b>804974</b>	grey	3,0	10
<b>804975</b>	grey	5,0	10
<b>804976</b>	grey	7,5	10
<b>804977</b>	grey	10,0	10
<b>805055</b>	grey	15,0	10

Dimensions and specifications may be changed without prior notice.

### Options

Naturally, we also offer other lengths and colors on request.





## Type

### Cable

Designation:  
Sheath material:  
Frequency:

## Patch cable S/FTP halogenfree, Cat.6

S/FTP 4x2xAWG 27/7 halogenfree  
LSZH  
up to 250 MHz

### Plug

Push-on connector type 1:  
Push-on connector type 2:  
Pin assignment:

RJ45 8(8)  
RJ45 8(8)  
1:1 acc. to TIA/EIA 568 B

### Flame proof

acc. to IEC 60332-1-2

### Norms and standards

HELUKAT® CONNECTING SYSTEMS® system components up to 250 MHz of category 6 / Class E in accordance with ISO 11801, 2nd edition, EN 50173, 2nd edition, and EIA/TIA 568 B.

### Preferred types

Part no.	Sheath colour	Length in metres	Unit
<b>82857</b>	grey	0,5	10
<b>82858</b>	grey	1,0	10
<b>82859</b>	grey	2,0	10
<b>82860</b>	grey	3,0	10
<b>82861</b>	grey	5,0	10
<b>82862</b>	grey	7,5	5
<b>82863</b>	grey	10,0	5
<b>82864</b>	grey	15,0	5

Part no.	Sheath colour	Length in metres	Unit
<b>802999</b>	blue	0,5	10
<b>803000</b>	blue	1,0	10
<b>803001</b>	blue	2,0	10
<b>803002</b>	blue	3,0	10
<b>803003</b>	blue	5,0	10
<b>803004</b>	blue	7,5	5
<b>803005</b>	blue	10,0	5
<b>803006</b>	blue	15,0	5

Part no.	Sheath colour	Length in metres	Unit
<b>803007</b>	green	0,5	10
<b>803008</b>	green	1,0	10
<b>803009</b>	green	2,0	10
<b>803010</b>	green	3,0	10
<b>803011</b>	green	5,0	10
<b>803012</b>	green	7,5	5
<b>803013</b>	green	10,0	5
<b>803014</b>	green	15,0	5

Continuation ►

# Patch Cables RJ45



Category 6 / Class E

Part no.	Sheath colour	Length in metres	Unit
<b>802991</b>	red	0,5	10
<b>802992</b>	red	1,0	10
<b>802993</b>	red	2,0	10
<b>802994</b>	red	3,0	10
<b>802995</b>	red	5,0	10
<b>802996</b>	red	7,5	5
<b>802997</b>	red	10,0	5
<b>802998</b>	red	15,0	5

Part no.	Sheath colour	Length in metres	Unit
<b>803015</b>	yellow	0,5	10
<b>803016</b>	yellow	1,0	10
<b>803017</b>	yellow	2,0	10
<b>803018</b>	yellow	3,0	10
<b>803019</b>	yellow	5,0	10
<b>803020</b>	yellow	7,5	5
<b>803021</b>	yellow	10,0	5
<b>803022</b>	yellow	15,0	5

Part no.	Sheath colour	Length in metres	Unit
<b>803023</b>	black	0,5	10
<b>803024</b>	black	1,0	10
<b>803025</b>	black	2,0	10
<b>803026</b>	black	3,0	10
<b>803027</b>	black	5,0	10
<b>803028</b>	black	7,5	5
<b>803029</b>	black	10,0	5
<b>803030</b>	black	15,0	5

Dimensions and specifications may be changed without prior notice.

## Options

Naturally, we also offer other lengths, colors and crossover cables on request.

# Patch Cables RJ45 unshielded



Category 6/ Class E



## Type

### Cable

Designation:  
Sheath material:  
Frequency:

## Patch cable unshielded U/UTP PVC, Cat.6

U/UTP 4x2xAWG 24/7 PVC  
PVC  
up to 250 MHz

### Plug

Push-on connector type 1:  
Push-on connector type 2:  
Pin assignment:

RJ45 8(8)  
RJ45 8(8)  
1:1 acc. to TIA/EIA 568 B

### Flame proof

acc. to IEC 60332-1-2

### Norms and standards

HELUKAT® CONNECTING SYSTEMS® system components up to 250 MHz in the of category 6 or EIA/TIA 568 B.

### Preferred types

Part no.	Sheath colour	Length in metres	Unit
803097	grey	0,5	10
803098	grey	1,0	10
803099	grey	2,0	10
803100	grey	3,0	10
803101	grey	5,0	10
803102	grey	7,5	10
803103	grey	10,0	10
803104	grey	15,0	10

Part no.	Sheath colour	Length in metres	Unit
803113	blue	0,5	10
803114	blue	1,0	10
803115	blue	2,0	10
803116	blue	3,0	10
803117	blue	5,0	10
803118	blue	7,5	10
803119	blue	10,0	10
803120	blue	15,0	10

Part no.	Sheath colour	Length in metres	Unit
803121	green	0,5	10
803122	green	1,0	10
803123	green	2,0	10
803124	green	3,0	10
803125	green	5,0	10
803126	green	7,5	10
803127	green	10,0	10
803128	green	15,0	10

Continuation ►

# Patch Cables RJ45 unshielded



Category 6/ Class E

Part no.	Sheath colour	Length in metres	Unit
803105	red	0,5	10
803106	red	1,0	10
803107	red	2,0	10
803108	red	3,0	10
803109	red	5,0	10
803110	red	7,5	10
803111	red	10,0	10
803112	red	15,0	10

Part no.	Sheath colour	Length in metres	Unit
803129	yellow	0,5	10
803130	yellow	1,0	10
803131	yellow	2,0	10
803132	yellow	3,0	10
803133	yellow	5,0	10
803134	yellow	7,5	10
803135	yellow	10,0	10
803136	yellow	15,0	10

Part no.	Sheath colour	Length in metres	Unit
803137	black	0,5	10
803138	black	1,0	10
803139	black	2,0	10
803140	black	3,0	10
803141	black	5,0	10
803142	black	7,5	10
803143	black	10,0	10
803144	black	15,0	10

Dimensions and specifications may be changed without prior notice.

## Options

Naturally, we also offer other lengths, colors and crossover cables on request.



## Type

### Cable

Designation:  
Sheath material:  
Frequency:

## Patch cable SF/UTP PVC Cat.5e

SF/UTP 4x2xAWG 26/7 PVC  
PVC  
up to 100 MHz

### Plug

Push-on connector type 1:  
Push-on connector type 2:  
Pin assignment:

RJ45 8(8)  
RJ45 8(8)  
1:1 acc. to TIA/EIA 568 B

### Flame proof

acc. to IEC 60332-1-2

### Norms and standards

HELUKAT® CONNECTING SYSTEMS® system components up to 100 MHz of category 5(e) / Class D in accordance with ISO 11801, 2nd edition, EN 50173, 2nd edition, and EIA/TIA 568 B.

### Preferred types

Part no.	Sheath colour	Length in metres	Unit
803049	grey	0,5	10
803050	grey	1,0	10
803051	grey	2,0	10
803052	grey	3,0	10
803053	grey	5,0	10
803054	grey	7,5	10
803055	grey	10,0	10
803056	grey	15,0	10

Part no.	Sheath colour	Length in metres	Unit
803065	blue	0,5	10
803066	blue	1,0	10
803067	blue	2,0	10
803068	blue	3,0	10
803069	blue	5,0	10
803070	blue	7,5	10
803071	blue	10,0	10
803072	blue	15,0	10

Part no.	Sheath colour	Length in metres	Unit
803073	green	0,5	10
803074	green	1,0	10
803075	green	2,0	10
803076	green	3,0	10
803077	green	5,0	10
803078	green	7,5	10
803079	green	10,0	10
803080	green	15,0	10

Continuation ►

# Patch Cables RJ45



Category 5e / Class D

Part no.	Sheath colour	Length in metres	Unit
<b>803057</b>	red	0,5	10
<b>803058</b>	red	1,0	10
<b>803059</b>	red	2,0	10
<b>803060</b>	red	3,0	10
<b>803061</b>	red	5,0	10
<b>803062</b>	red	7,5	10
<b>803063</b>	red	10,0	10
<b>803064</b>	red	15,0	10

Part no.	Sheath colour	Length in metres	Unit
<b>803081</b>	yellow	0,5	10
<b>803082</b>	yellow	1,0	10
<b>803083</b>	yellow	2,0	10
<b>803084</b>	yellow	3,0	10
<b>803085</b>	yellow	5,0	10
<b>803086</b>	yellow	7,5	10
<b>803087</b>	yellow	10,0	10
<b>803088</b>	yellow	15,0	10

Part no.	Sheath colour	Length in metres	Unit
<b>803089</b>	black	0,5	10
<b>803090</b>	black	1,0	10
<b>803091</b>	black	2,0	10
<b>803092</b>	black	3,0	10
<b>803093</b>	black	5,0	10
<b>803094</b>	black	7,5	10
<b>803095</b>	black	10,0	10
<b>803096</b>	black	15,0	10

Dimensions and specifications may be changed without prior notice.

## Options

Naturally, we also offer other lengths, colors and crossover cables on request.

# Patch Cables RJ45



Category 5e / Class D



## Type

### Cable

Designation:  
Sheath material:  
Frequency:

## Patch cable U/UTP PVC Cat.5e

U/UTP 4x2xAWG 24/7 PVC  
PVC  
up to 155 MHz

### Plug

Push-on connector type 1:  
Push-on connector type 2:  
Pin assignment:

RJ45 8(8)  
RJ45 8(8)  
1:1 acc. to TIA/EIA 568 B

### Flame proof

acc. to IEC 60332-1-2

### Norms and standards

HELUKAT® CONNECTING SYSTEMS® system components up to 155 MHz of category 5e in accordance with ISO 11801, EIA/TIA 568 B.

### Preferred types

Part no.	Sheath colour	Length in metres	Unit
<b>804646</b>	grey	0,5	10
<b>804647</b>	grey	1,0	10
<b>805738</b>	grey	5,0	10
<b>805739</b>	grey	7,5	10
<b>804648</b>	grey	3,0	10
<b>805737</b>	grey	2,0	10
<b>805740</b>	grey	10,0	10
<b>805741</b>	grey	15,0	10

Dimensions and specifications may be changed without prior notice.

### Options

Naturally, we also offer other lengths, colors and crossover cables on request.



## Preferred types

Part no.	Description	Colour	Unit
<b>801686</b>	RJ45 plug 8 pole Category 5, TM11 grey	grey	10
<b>801772</b>	RJ45 plug 8 pole Category 6, TM21 black	black	10
<b>82852</b>	RJ-45 AP-frame	Pure White similar to RAL 9010	5
<b>82695</b>	RJ-45 AP-frame cat.5 socket	Pearl White similar to RAL 1013	5
<b>800260</b>	Central plate 80x80 UP-socket	Pure White similar to RAL 9010	10

Dimensions and specifications may be changed without prior notice.



# Rubber Cable Reels

HELUKAT® Datacables



## Type

### Drum

Equipment:

### Plug

Push-On connector type 1:

Push-On connector type 2:

System type:

Pin assignment:

## Norms and standards

## Preferred types

## Characteristics

## Options

## Rubber cable reel with HELUKAT® copper data cable

### Rubber

with supporting frame

RJ45 8/8 - jack

RJ45 8/8 - jack

office connector

1:1 acc. to TIA/EIA 568 B

Components of HELUKAT® CONNECTING SYSTEMS® to 155 MHz acc. Categorie 5E and to 600MHz acc. Categorie 6 (Link), ISO 11801 1st Edition, EN 50173-3 and EIA/TIA 568 B. Be in accordance with the Cat.5E respectively the Cat. 6 structured cabling.

Part no.	Designation	Sheath colour	Frequency MHz	Cable length m	Flame proof	Oil-resistant
802073	FTP 4x2xAWG24/1 PVC	Yellow similar to RAL 1021	155	50,0	-	-
802074	FTP 4x2xAWG24/1 PVC	Yellow similar to RAL 1021	155	90,0	-	-
802075	S-STP 4x2xAWG 23/1 FRNC	Blue Lilac similar to RAL 4005	600	50,0	acc. to IEC 60332-3	-
802076	S-STP 4x2xAWG 23/1 FRNC	Blue Lilac similar to RAL 4005	600	90,0	acc. to IEC 60332-3	-
802207	S-STP 4x2xAWG 23/1 PUR	Green similar to RAL 6018	600	50,0	acc. to IEC 60332-1-2	EN60811-2-1
802208	S-STP 4x2xAWG 23/1 PUR	Green similar to RAL 6018	600	90,0	acc. to IEC 60332-1-2	EN60811-2-1

Dimensions and specifications may be changed without prior notice.

Rubber cable reel with RJ45 jacks and dust protection. Suitable for mobile use on site, for example for meetings, TV-Transmissions, Fairs, etc.. Everywhere when there is a need for a removable cable connection. Usable for fixed installation cabling.

We also can deliver other cable length, cross-over cables or other types of plugs.



# ■ COPPER CONNECTING EQUIPMENT

Designation	Page
<b>Connection Technics Industry</b>	
Copper connectors overview	258
DIN rail distribution panels copper, modular	260
Top-hat rail installation modul 2xRJ45/LSA, Cat.6	261
Industrial Ethernet RJ45 outlets IP67	262
Industrial Ethernet M12 (D+B coded) outlets IP67	263
Top-hat rail installation data outlets Cat.6/ Class E	264
Patch Cable RJ45 HARTING HAN® 3A IP67, PROFINet A fixed installation	265
Patch Cable RJ45 HARTING Push-Pull plastic IP65/67, PROFINet A fixed installation	266
Patch Cable RJ45 HARTING HAN® 3A IP67, PROFINet C drag chain	267
Patch Cable RJ45 HARTING Push-Pull IP67, PROFINet C drag chain	268
Patch Cable RJ45 PHOENIX Variosub IP67, LAN-Industry drag chain	269
Adapter Cable RJ45 HARTING IP20 to HAN® 3A IP67, PROFINet A fixed installation	270
Patch Cable RJ45 HARTING Industrial IP20, PROFINet A fixed installation	271
Patch Cable RJ45 HARTING Industrial IP20 angled left, PROFINet A fixed installation	272
Patch Cable RJ45 HARTING Industrial IP20, LAN-Industry flexible	273
Patch Cable RJ45 8P HARTING INDUSTRIAL IP20, LAN-Industry	274
Patch Cable RJ45 HARTING Industrial IP20, PROFINet C drag chain	275
Patch Cable RJ45 HARTING IP20, LAN-Industry drag chain	276
Patch Cable RJ45 LAN-Industry PHOENIX Variosub IP20, drag chain	277
Patch Cable USB 2.0 A, industrial USB – drag chain	278
Patch Cable M12 LAN-Industry IP67, drag chain	279
Patch Cable M12W LAN-Industry IP67, drag chain	280
Patch Cable M12 for Profibus RS 485, drag chain	281
Patch Cable M12W for Profibus RS 485, drag chain	282
RJ45 industrial plugs IP20 and IP65/67	283
RJ45 industrial plugs IP20 and IP65/67	284
PROFIBUS Sub-D connectors	285
PROFIBUS Adaptor Sub-D/M12 with and without PG	286

# ■ COPPER CONNECTORS OVERVIEW

## Plug RJ45 Industrial



- plastic housing
- IP20, light duty
- Category 5
- IEC 60603-7
- Field-processable

## Plug RJ45 Industrial



- plastic housing
- IP20, light duty
- Category 5
- IEC 60603-7
- Field-processable

## Plug RJ45 PROFINet IE



- Central construction
- plastic housing
- IP20, light duty
- Category 5e
- Field-processable

## Plug RJ45 Industrial



- plastic housing
- IP20
- Category 5
- IEC 60603-7
- Field-processable

## Plug RJ45 PROFINet IE



- Central construction
- metal housing
- IP20, light duty
- Category 5e
- Field-processable

## Plug RJ45 PROFINet IE



- Angled construction
- metal housing
- IP20, light duty
- Category 5e
- Field-processable

### Plug RJ45 PROFINet IE



- Angled construction
- plastic housing
- IP20, light duty
- Category 5e
- Field-processable

### Plug RJ45 Snap-In IE



- Central construction
- plastic housing
- IP67, heavy duty
- Category 5

### Plug RJ45 10GIG IE



- Central + Angled construction
- plastic housing
- IP20, light duty
- Category 6/ Classe EA
- Field-processable

### Plug RJ45 10GIG IE



- Central construction
- metal housing
- IP20, light duty
- Category 6A
- Field-processable

### Plug M12 D- /B-codet



- metal housing / plastic housing
- IP67, heavy duty
- Category 5 (IEC 61076-2-101)
- Profibus

### Plug SUB-D for PROFIBUS and CAN



- 180°, 90°, 45°, 35° execution
- metal housing
- IP20, light duty
- With and Without PG
- With and Without Diagnose function
- Field-processable

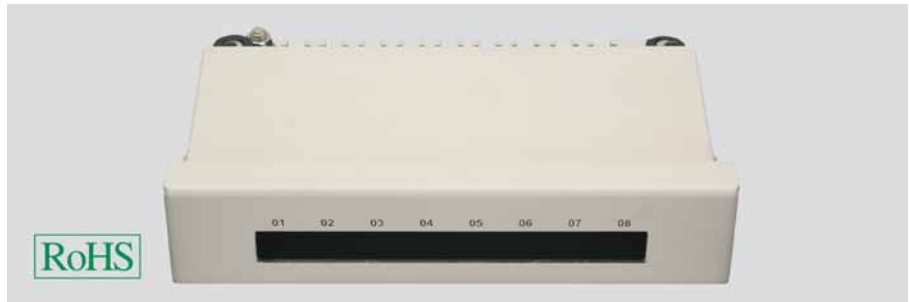

### Type

#### Cable structure

Housing material:  
Colour:  
Max. number of modules:  
Screen removal:  
Strain relief:  
Cover lock:

#### Basic Panel

Steel plate, solid  
Grey similar to RAL 7035  
8  
via continuous screening tape  
by means of cable straps  
Quick-action twist lock

#### Dimension

Width:  
Depth:  
Number of height modules (HM):

195 mm  
150 mm  
1

**Part no.:**  
Packing unit:

**801311**  
5

### Type

Plug type A:  
Pin Code A:  
Plug type B:  
Pin Code B:  
Shielding:

**Part no.:**  
Packing unit:

#### Modul for top-hat rail installation patch panel, 2xST MM

-  
-  
-  
-

**801314**  
10

### Type

Plug type A:  
Pin Code A:  
Plug type B:  
Pin Code B:  
Shielding:

**Part no.:**  
Packing unit:

#### Modul for top-hat rail installation patch panel, 2xSC MM

-  
-  
-  
-

**801315**  
1

### Norms and standards

HELUKAT® CONNECTING SYSTEMS® INDUSTRY individual system components, category 6 de-embedded (IEC 60603-7-5), ISO 11801 2nd Edition, EN 50173-1 2nd Edition, EIA/TIA 568-B.2-1 and EN 55022 (EMV).

### Application

As connection distribution unit for DIN rail installation e.g. in the switch cabinet, for applications involving digital and analog image, data and voice transmission. Can be combined (also with fibre optic components) thanks to the modular structure. Tool-free turn latches enable simple closing and opening of the housing.

Dimensions and specifications may be changed without prior notice.

# Top hat rail modules

INDUSTRIAL ETHERNET



Duplex modul cat.6 de-embedded



## Type

### Configuration

Housing material:	Steel plate, solid
Board:	Individual - modular
Push-on connector type:	RJ45(8/8)
Number of bushes:	2
Type of screen:	Overall screen
Screen removal:	via clips
Strain relief:	via pre-installed cable clips
Cover lock:	Fastening by means of screws

### Connecting system

Connection type:	LSA plus - insulation piercing connections
Suitable for cable diameter:	0.4 - 0.64mm (AWG 26 - 22)

### Assignment type

EIA/TIA 568 A + EIA/TIA 568 B

### Dimension

Width:	36 mm
Depth:	110 mm

### Norms and standards

HELUKAT® CONNECTING SYSTEMS® INDUSTRY individual system components, category 6, ISO 11801 2nd Edition, EN 50173-1 2nd Edition, EIA/TIA 568-B.2-1 and EN 55022 (EMV)

### Application

As connection distribution unit for DIN rail installation e.g. in the switch cabinet, for applications involving digital and analog image, data and voice transmission.

### Part no.

**801310**

Dimensions and specifications may be changed without prior notice.

### Packing unit

**10**

# Machine outlet IP67

INDUSTRIAL ETHERNET



VARIOSUB, HAN® 3A



## Type

**Ind.Outlet Metal, Cat.6  
RJ45-IP67-VARIOSUB  
PHOENIX**

**Ind.Outlet Metal, Cat.5  
RJ45-IP67 HAN 3A HARTING**

## Configuration

Housing material:  
Colour:  
Board:  
Push-on connector type:  
Outlet direction:  
Number of bushes:  
Type of screen:  
Strain relief:  
Cable inlet:

Aluminium die-cast, shielded  
Grey  
1x2  
RJ45(8/8)  
Straight  
2  
Overall screen  
via pre-installed cable clips  
horizontal  
vertical  
67

Aluminium die-cast, shielded  
Grey  
1x2  
RJ45(8/8)  
Straight  
2  
Overall screen  
via pre-installed cable clips  
horizontal  
vertical  
67

Protection classification (IP):

## Connecting system

Connection type:  
Suitable for cable diameter:  
Insulation diameter, min.:

LSA plus - insulation piercing connections  
0,4 - 0,64mm (AWG 26 - 22)  
0,7 - 1,7 mm (PE)

LSA plus - insulation piercing connections  
0,4 - 0,64mm (AWG 26 - 22)  
0,7 - 1,7 mm (PE)

## Assignment type

EIA/TIA 568 A + EIA/TIA 568 B

EIA/TIA 568 A + EIA/TIA 568 B

## Dimension

Installation dimensions:

175 x 110 x 45mm

175 x 110 x 45mm

## Norms and standards

HELUKAT® CONNECTING SYSTEMS INDUSTRY® components up to 100 MHz category 5 in accordance with ISO/IEC 11801 2nd Edition, EN50173 2nd Edition. Moreover it satisfies the MICE specifications (class 3), EMC requirements in accordance with DIN EN 6100, and the requirements of the IP 67 housing protection class.

## Application

Robust data connection socket (shielded) for the extreme implementation. Robust aluminum die-cast housing, meets all mechanical requirements like vibration, shock, and transverse forces. The socket is used either on the machine distributor (MD) or wall mounted directly on the machine (MC) as connection unit.

## Part no.

**801278**

**801306**

Dimensions and specifications may be changed without prior notice.

## Packing unit

**5**

**5**



# Machine outlet IP67

INDUSTRIAL ETHERNET



M12 D-coded, B-coded



## Type

**Ind.Outlet Metal, Cat.5, 2 x M12 D-coded, IP67**

**Ind.Outlet Metal, 2 x M12 B-coded, IP67**

## Configuration

Housing material:  
Colour:  
Board:  
Push-on connector type:  
Outlet direction:  
Number of bushes:  
Type of screen:  
Strain relief:  
Cable inlet:  
  
Protection classification (IP):

Aluminium die-cast, shielded  
Grey  
1x2  
plug M12  
Straight  
2  
Overall screen  
via pre-installed cable clips  
horizontal  
vertical  
67

Aluminium die-cast, shielded  
Grey  
1x2  
plug M12  
Straight  
2  
Overall screen  
via pre-installed cable clips  
horizontal  
vertical  
67

## Connecting system

Connection type:  
Suitable for cable diameter:  
Insulation diameter, min.:

LSA plus - insulation piercing connections  
0,4 - 0,64mm (AWG 26 - 22)  
0,7 - 1,7 mm (PE)

LSA plus - insulation piercing connections  
0,4 - 0,64mm (AWG 26 - 22)  
0,7 - 1,7 mm (PE)

## Assignment type

D-coded acc. DKE/IEC 61076-2-101

B-coded acc. DKE/IEC 61076-2-101

## Dimension

Installation dimensions:

175 x 110 x 45mm

175 x 110 x 45mm

## Norms and standards

HELUKAT® CONNECTING SYSTEMS® INDUSTRY components up to 100 MHz category 5 in accordance with ISO/IEC 11801 2nd Edition, EN50173 2nd Edition. Couplings in accordance with IEC 61076.2191-A1 Moreover it satisfies the MICE specifications (class 3), EMC requirements in accordance with DIN EN 6100, and the requirements of the IP 67 housing protection class.

## Application

Robust data connection socket (shielded) for the extreme implementation. Robust aluminum die-cast housing; meets all mechanical requirements like vibration, shock, and transverse forces. The socket is used either on the machine distributor (MD) or wall mounted directly on the machine (MC) as connection unit.

## Part no.

**801305**

**801312**

Dimensions and specifications may be changed without prior notice.

## Packing unit

**5**

**5**

# Outlet top hat rail

INDUSTRIAL ETHERNET



RJ45, horizontal/vertical



## Type

**Top-hat rail outlet 2xRJ-45  
cat.6/Class E 2P horizontal**

**Top-hat rail outlet 2xRJ-45  
cat.6/Class E 2P vertical**

## Configuration

Housing material:  
Colour:  
Board:  
Push-on connector type:  
Outlet direction:  
Number of bushes:  
Type of screen:  
Strain relief:  
Cable inlet:

Plastic, shielded  
Pure White similar to RAL 9010  
1x2  
RJ45(8/8)  
45 degrees  
2  
Overall screen  
via pre-installed cable clips  
horizontal

Plastic, shielded  
Pure White similar to RAL 9010  
1x2  
RJ45(8/8)  
45 degrees  
2  
Overall screen  
via pre-installed cable clips  
vertical

## Connecting system

Connection type:  
Suitable for cable diameter:  
Insulation diameter, min.:

LSA plus - insulation piercing connections  
0,4 - 0,64mm (AWG 26 - 22)  
0,7 - 1,7 mm (PE)

LSA plus - insulation piercing connections  
0,4 - 0,64mm (AWG 26 - 22)  
0,7 - 1,7 mm (PE)

## Assignment type

EIA/TIA 568 A + EIA/TIA 568 B

EIA/TIA 568 A + EIA/TIA 568 B

## Dimension

Dimensions of central plate:  
Installation dimensions:

50 x 50mm  
80 x 80 x 46mm

50 x 50mm  
80 x 80 x 46mm

## Norms and standards

HELUKAT® CONNECTING SYSTEMS® INDUSTRY system component up to 250 MHz in the permanent link of category 6 or Class E in accordance with ISO 11801, 2nd edition, EN 50173, 2nd edition, EIA/TIA 568 B, and EN 55022 (EMC)

## Application

As connection unit for DIN rail installation e.g. in the switch cabinet, for applications involving digital and analog image, data and voice transmission.

## Part no.

**801308**

**801309**

Dimensions and specifications may be changed without prior notice.

## Packing unit

**10**

**10**

# Patch Cables PROFinet A



RJ45-HAN® 3A, IP67



## Type

### Patch Cable RJ45 HARTING HAN® 3A IP67, PROFinet A fixed installation

#### Cable

Designation:  
Sheath material:  
Frequency:

PROFinet type A (SK)  
PVC  
up to 100 MHz

#### Plug

Push-on connector type 1:  
Push-on connector type 2:  
System type:  
Pin assignment:

RJ45-connector IP67  
RJ45-connector IP67  
Harting IP67 HAN® 3A metal  
1:1 acc. to TIA/EIA 568 B

#### Flame proof

acc. to IEC 60332-1-2

#### Oil-resistant

Acc. to EN60811-2-1

#### Norms and standards

Components of HELUKAT® CONNECTING SYSTEMS® to 100 MHz acc. Categorie 5, ISO 11801 1st Edition, EN 50173-3, EIA/TIA 568 B and IEC 61918. Support the PROFinet guideline V 1.8.

#### Preferred types

Part no.	Sheath colour	Length in metres	Unit
<b>801342</b>	green	0,5	10
<b>801343</b>	green	1,0	10
<b>801344</b>	green	2,0	10
<b>801345</b>	green	3,0	10
<b>801346</b>	green	5,0	10
<b>801347</b>	green	10,0	10
<b>801365</b>	green	15,0	10
<b>801366</b>	green	50,0	5
<b>801367</b>	green	100,0	1

Dimensions and specifications may be changed without prior notice.

#### Characteristics

Jumper cable for the connection between IP67 protected ethernet applications according ISO/IEC 11801 with RJ45 plugs. Usable for fixed installation cabling.

#### Options

We also can deliver other cable length, cross-over cables or other types of plugs.

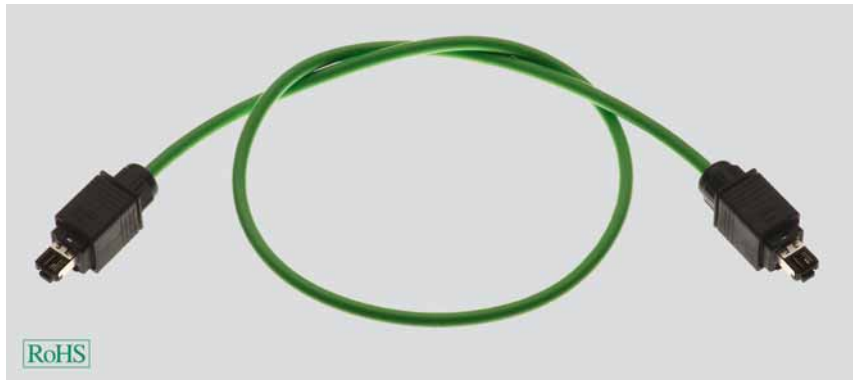

## Type

### Patch Cable RJ45 HARTING Push-Pull plastic IP65/67, PROInet A fixed installation

## Cable

Designation:  
Sheath material:  
Frequency:

PROInet type A (SK)  
PVC  
up to 100 MHz

## Plug

Push-on connector type 1:  
Push-on connector type 2:  
System type:  
Pin assignment:

RJ45-connector IP67  
RJ45-connector IP67  
Harting IP65/67 HAN® PushPull 4P plastic  
1:1 acc. to TIA/EIA 568 B

## Flame proof

acc. to IEC 60332-1-2

## Oil-resistant

Acc. to EN60811-2-1

## Norms and standards

Components of HELUKAT® CONNECTING SYSTEMS® to 100 MHz acc. Categorie 5, ISO 11801 1st Edition, EN 50173-3, EIA/TIA 568 B and ISO/IEC 24702 variant 14 (AIDA conform). Support the PROInet guideline V 1.8.

## Preferred types

Part no.	Sheath colour	Length in metres	Unit
<b>802423</b>	green	1,5	10
<b>802424</b>	green	3,0	10
<b>802425</b>	green	5,0	10
<b>802426</b>	green	10,0	10
<b>802427</b>	green	20,0	10
<b>802428</b>	green	50,0	5
<b>802429</b>	green	100,0	1

Dimensions and specifications may be changed without prior notice.

## Characteristics

Jumper cable for the connection between IP67 protected ethernet applications according ISO/IEC 11801 with RJ45 plugs. Usable for fixed installation cabling.

## Options

We also can deliver other cable length, cross-over cables or other types of plugs.



## Type

## Patch Cable RJ45 HARTING HAN® 3A IP67, PROFinet C Drag Chain

### Cable

Designation:  
Sheath material:  
Frequency:

PROFinet type C (SK)  
PUR  
up to 100 MHz

### Plug

Push-on connector type 1:  
Push-on connector type 2:  
System type:  
Pin assignment:

RJ45-connector IP67  
RJ45-connector IP67  
Harting IP67 HAN® 3A metal  
1:1 acc. to TIA/EIA 568 B

### Flame proof

acc. to IEC 60332-1-2

### Oil-resistant

Acc. to EN60811-2-1

### Norms and standards

Components of HELUKAT® CONNECTING SYSTEMS® to 100 MHz acc. Categorie 5, ISO 11801 1st Edition, EN 50173-3, EIA/TIA 568 B and IEC 61918. Support the PROFinet guideline V 1.8.

### Preferred types

Part no.	Sheath colour	Length in metres	Unit
<b>801332</b>	green	0,5	10
<b>801333</b>	green	1,0	10
<b>801334</b>	green	2,0	10
<b>801335</b>	green	3,0	10
<b>801336</b>	green	5,0	10
<b>801337</b>	green	10,0	10

Dimensions and specifications may be changed without prior notice.

### Characteristics

- Drag Chain suitable
- Bending radius 7,5 x cable outerdiameter maximum
- Moving speed 240 m/min maximum
- Movement distance 10 m maximum
- Acceleration 4 m/s<sup>2</sup> maximum
- Cycles maximum 5 Mio.
- Temperature range from -40°C to +80°C
- Transmission rate maximum 100 Mbit/s
- Transmission distance maximum 100 m from the Hub to the receiver
- Suitable for the „Heavy-Duty“ range.

### Options

We also can deliver other cable length, cross-over cables or other types of plugs.



## Type

### Patch Cable RJ45 HARTING Push-Pull IP67, PROFinet C Drag Chain

## Cable

Designation: PROFinet type C (SK)  
 Sheath material: PUR  
 Frequency: up to 100 MHz

## Plug

Push-on connector type 1: RJ45-connector IP67  
 Push-on connector type 2: RJ45-connector IP67  
 System type: Harting IP65/67 HAN® PushPull 4P plastic  
 Pin assignment: 1:1 acc. to TIA/EIA 568 B

## Flame proof

acc. to IEC 60332-1-2

## Oil-resistant

Acc. to EN60811-2-1

## Norms and standards

Components of HELUKAT® CONNECTING SYSTEMS® to 100 MHz acc. Categorie 5, ISO 11801 1st Edition, EN 50173-1, EIA/TIA 568 B and ISO/IEC 24702 - variant 14 (AIDA konform). Support the PROFinet guideline V 1.8.

## Preferred types

Part no.	Sheath colour	Length in metres	Unit
<b>802395</b>	green	0,5	10
<b>802396</b>	green	1,0	10
<b>802397</b>	green	2,0	10
<b>802398</b>	green	3,0	10
<b>802399</b>	green	5,0	10
<b>802400</b>	green	10,0	10

Dimensions and specifications may be changed without prior notice.

## Characteristics

- Drag Chain suitable
- Bending radius 7,5 x cable outerdiameter maximum
- Moving speed 240 m/min maximum
- Movement distance 10 m maximum
- Acceleration 4 m/s<sup>2</sup> maximum
- Cycles maximum 5 Mio.
- Temperature range from -40°C to +80°C
- Transmission rate maximum 100 Mbit/s
- Transmission distance maximum 100 m from the Hub to the receiver
- Suitable for the „Heavy-Duty“ range.

## Options

We also can deliver other cable length, cross-over cables or other types of plugs.



## Type

## Patch Cable RJ45 PHOENIX Variosub IP67, LAN-Industry Drag Chain

### Cable

Designation:  
Sheath material:  
Frequency:

LAN industry 4x2x0,15  
PUR  
up to 100 MHz

### Plug

Push-on connector type 1:  
Push-on connector type 2:  
System type:  
Pin assignment:

RJ45-connector IP67  
RJ45-connector IP67  
Phoenix Variosub IP67  
1:1 acc. to TIA/EIA 568 B

### Flame proof

acc. to IEC 60332-1-2

### Oil-resistant

Acc. to EN60811-2-1

### Norms and standards

Components of HELUKAT® CONNECTING SYSTEMS® to 100 MHz acc. Categorie 5, ISO 11801 1st Edition, EN 50173-3 and EIA/TIA 568 B.

### Preferred types

Part no.	Sheath colour	Length in metres	Unit
<b>800827</b>	green	0,5	10
<b>800828</b>	green	1,0	10
<b>800829</b>	green	2,0	10
<b>800830</b>	green	3,0	10
<b>800831</b>	green	5,0	10
<b>800832</b>	green	10,0	10

Dimensions and specifications may be changed without prior notice.

### Characteristics

- Drag Chain suitable
- Bending radius 7,5 x cable outerdiameter maximum
- Moving speed 180 m/min maximum
- Movement distance 6 m maximum
- Acceleration 5 m/s<sup>2</sup> maximum
- Cycles maximum 10 Mio.
- Temperature range from -40°C to +80°C
- Transmission rate maximum 100 Mbit/s
- Transmission distance maximum 50 m from the Hub to the receiver
- Suitable for the „Heavy-Duty“ range.

### Options

We also can deliver other cable length, cross-over cables or other types of plugs.

# Adapter Cables PROFINet A



RJ45, RJ-INDUSTRIAL IP20 to HAN® 3A IP67



## Type

### Adapter cable RJ45 HARTING IP20 to HAN® 3A IP67, PROFINet A fixed installation

## Cable

Designation: PROFINet type A (SK)  
Sheath material: PVC  
Frequency: up to 100 MHz

## Plug

Push-on connector type 1: RJ45-connector IP20  
Push-on connector type 2: RJ45-connector IP67  
System type: Harting IP67 to IP20  
Pin assignment: 1:1 acc. to TIA/EIA 568 B

## Flame proof

acc. to IEC 60332-1-2

## Oil-resistant

Acc. to EN60811-2-1

## Norms and standards

Components of HELUKAT® CONNECTING SYSTEMS® to 100 MHz acc. Categorie 5, ISO 11801 1st Edition, EN 50173-3, EIA/TIA 568 B and IEC 61918. Support the PROFINet guideline V 1.8.

## Preferred types

Part no.	Sheath colour	Length in metres	Unit
<b>801338</b>	green	10,0	10
<b>801339</b>	green	15,0	10
<b>801340</b>	green	50,0	5
<b>801341</b>	green	100,0	1

Dimensions and specifications may be changed without prior notice.

## Characteristics

Adapter cable for the connection between IP20 protected and IP67 protected ethernet applications according ISO/IEC 11801 with RJ45 plugs. Usable for fixed installation cabling.

## Options

We also can deliver other cable length, cross-over cables or other types of plugs.





## Type

## Patch Cable RJ45 HARTING Industrial IP20, PROFinet A fixed installation

### Cable

Designation: PROFinet type A (SK)  
 Sheath material: PVC  
 Frequency: up to 100 MHz

### Plug

Push-on connector type 1: RJ45-connector IP20  
 Push-on connector type 2: RJ45-connector IP20  
 System type: Harting IP20 Industrial 4P  
 Pin assignment: 1:1 acc. to TIA/EIA 568 B

### Flame proof

acc. to IEC 60332-1-2

### Oil-resistant

Acc. to EN60811-2-1

### Norms and standards

Components of HELUKAT® CONNECTING SYSTEMS® to 100 MHz acc. Categorie 5, ISO 11801 1st Edition, EN 50173-3, EIA/TIA 568 B and IEC 60603-7. Support the PROFinet guideline V 1.8.

### Preferred types

Part no.	Sheath colour	Length in metres	Unit
<b>802416</b>	green	1,5	10
<b>802417</b>	green	3,0	10
<b>802418</b>	green	5,0	10
<b>802419</b>	green	10,0	10
<b>802420</b>	green	20,0	5
<b>802421</b>	green	50,0	5
<b>802422</b>	green	100,0	1

Dimensions and specifications may be changed without prior notice.

### Characteristics

Jumper cable for the connection between IP20 protected ethernet applications according ISO/IEC 11801 with RJ45 plugs. Usable for fixed installation cabling.

### Options

We also can deliver other cable length, cross-over cables or other types of plugs.



## Type

### Patch Cable RJ45 HARTING Industrial IP20 angled left, PROFinet A fixed installation

## Cable

Designation: PROFinet type A (SK)  
 Sheath material: PVC  
 Frequency: up to 100 MHz

## Plug

Push-on connector type 1: RJ45-connector IP20  
 Push-on connector type 2: open  
 System type: Harting RJ Robust IP20 angled left  
 Pin assignment: 1:1 acc. to TIA/EIA 568 B

## Flame proof

acc. to IEC 60332-1-2

## Oil-resistant

Acc. to EN60811-2-1

## Norms and standards

Components of HELUKAT® CONNECTING SYSTEMS® to 100 MHz acc. Categorie 5, ISO 11801 1st Edition, EN 50173-3, EIA/TIA 568 B and IEC 60603-7. Support the PROFinet guideline V 1.8.

## Preferred types

Part no.	Sheath colour	Length in metres	Unit
<b>802410</b>	green	0,5	10
<b>802411</b>	green	1,0	10
<b>802412</b>	green	2,0	10
<b>802413</b>	green	3,0	10
<b>802414</b>	green	5,0	10
<b>802415</b>	green	10,0	10

Dimensions and specifications may be changed without prior notice.

## Characteristics

Jumper cable for the connection between IP20 protected ethernet applications according ISO/IEC 11801 with RJ45 plug, second side without plug. Usable for fixed installation cabling within cabinets or controllers.

## Options

We also can deliver other cable length, cross-over cables or other types of plugs.



### Type

### Patch Cable RJ45 HARTING Industrial IP20, LAN-Industry flexible

#### Cable

Designation:  
Sheath material:  
Frequency:

SF/UTP 4x2xAWG 26/7 PUR  
PUR  
up to 100 MHz

#### Plug

Push-on connector type 1:  
Push-on connector type 2:  
System type:  
Pin assignment:

RJ45-connector IP20  
RJ45-connector IP20  
Harting IP20 Industrial 4P  
1:1 acc. to TIA/EIA 568 B

#### Flame proof

acc. to IEC 60332-1-2

#### Oil-resistant

Acc. to EN60811-2-1

#### Norms and standards

Components of HELUKAT® CONNECTING SYSTEMS® to 100 MHz acc. Categorie 5, ISO 11801 1st Edition, EN 50173-3, EIA/TIA 568 B and IEC 60603-7.

#### Preferred types

Part no.	Sheath colour	Length in metres	Unit
<b>800839</b>	grey	0,5	10
<b>800840</b>	grey	1,0	10
<b>800841</b>	grey	2,0	10
<b>800842</b>	grey	3,0	10
<b>800843</b>	grey	5,0	10
<b>800844</b>	grey	10,0	10

Dimensions and specifications may be changed without prior notice.

#### Characteristics

- Suitable for using in rough environs
- Suitable for normal movements
- Temperature range from -20°C to +60°C
- Transmission rate maximum 100 Mbit/s
- Transmission distance maximum 30m from the Hub to the receiver
- Suitable for the „Light-Duty“ range

#### Options

We also can deliver other cable length, cross-over cables or other types of plugs.



## Type

### Patch Cable RJ45 8P HARTING INDUSTRIAL IP20, LAN-Industry

## Cable

Designation: S/FTP 4x2xAWG 26/7 PUR, UL  
 Sheath material: PUR  
 Frequency: up to 600 MHz

## Plug

Push-on connector type 1: RJ45-connector IP20  
 Push-on connector type 2: RJ45-connector IP20  
 System type: Harting IP20 RJ Industrial 8P  
 Pin assignment: 1:1 acc. to TIA/EIA 568 B

## Flame proof

acc. to IEC 60332-1-2

## Oil-resistant

Acc. to EN60811-2-1

## Norms and standards

Components of HELUKAT® CONNECTING SYSTEMS® to 250 MHz acc. Categorie 6/ Class E, ISO 11801 1st Edition, EN 50173-1 and EIA/TIA 568 B. Plug according IEC 60603-7 and Category 6.

## Preferred types

Part no.	Sheath colour	Length in metres	Unit
<b>802389</b>	green	0,5	10
<b>802390</b>	green	1,0	10
<b>802391</b>	green	2,0	10
<b>802392</b>	green	3,0	10
<b>802393</b>	green	5,0	10
<b>802394</b>	green	10,0	10

Dimensions and specifications may be changed without prior notice.

## Characteristics

- Suitable for using in rough environs
- Suitable for normal movements
- Temperature range from -40°C to +80°C
- Transmission rate maximum 100 Mbit/s
- Transmission distance maximum 30m from the Hub to the receiver
- Suitable for the „Light-Duty“ range

## Options

We also can deliver other cable length, cross-over cables or other types of plugs.

# Rangierkabel PROFINet C



RJ45 4P INDUSTRIAL IP20



## Type

### Patch Cable RJ45 HARTING Industrial IP20, PROFINet C Drag Chain

#### Cable

Designation:  
Sheath material:  
Frequency:

PROFINet type C (SK)  
PUR  
up to 100 MHz

#### Plug

Push-on connector type 1:  
Push-on connector type 2:  
System type:  
Pin assignment:

RJ45-connector IP20  
RJ45-connector IP20  
Harting IP20 Industrial 4P  
1:1 acc. to TIA/EIA 568 B

#### Flame proof

acc. to IEC 60332-1-2

#### Oil-resistant

Acc. to EN60811-2-1

#### Norms and standards

Components of HELUKAT® CONNECTING SYSTEMS® to 100 MHz acc. Categorie 5, ISO 11801 1st Edition, EN 50173-1, EIA/TIA 568 B and EN 60603-7. Support the PROFINet guideline V 1.8.

#### Preferred types

Part no.	Sheath colour	Length in metres	Unit
<b>802432</b>	green	0,5	10
<b>802433</b>	green	1,0	10
<b>802434</b>	green	2,0	10
<b>802435</b>	green	3,0	10
<b>802436</b>	green	5,0	10
<b>802437</b>	green	10,0	10

Dimensions and specifications may be changed without prior notice.

#### Characteristics

- Drag Chain suitable
- Bending radius 7,5 x cable outerdiameter maximum
- Moving speed 240 m/min maximum
- Movement distance 10 m maximum
- Acceleration 4 m/s<sup>2</sup> maximum
- Cycles maximum 5 Mio.
- Temperature range from -40°C to +80°C
- Transmission rate maximum 100 Mbit/s
- Transmission distance maximum 100 m from the Hub to the receiver
- Suitable for the „Light-Duty“ range.

#### Options

We also can deliver other cable length, cross-over cables or other types of plugs.



## Type

### Cable

Designation:  
Sheath material:  
Frequency:

SF/UTP 4x1xAWG 24/19 PUR  
PUR  
up to 100 MHz

### Plug

Push-on connector type 1:  
Push-on connector type 2:  
System type:  
Pin assignment:

RJ45-connector IP20  
RJ45-connector IP20  
Harting IP20 Industrial 4P  
1:1 acc. to TIA/EIA 568 B

### Flame proof

acc. to IEC 60332-1-2

### Oil-resistant

Acc. to EN60811-2-1

### Norms and standards

Components of HELUKAT® CONNECTING SYSTEMS® to 100 MHz acc. Categorie 5, ISO 11801 1st Edition, EN 50173-3 and EIA/TIA 568 B. Support the ISO/IEC 24702 and IEC 61076-3-106.

### Preferred types

Part no.	Sheath colour	Length in metres	Unit
<b>800833</b>	green	0,5	10
<b>800834</b>	green	1,0	10
<b>800835</b>	green	2,0	10
<b>800836</b>	green	3,0	10
<b>800837</b>	green	5,0	10
<b>800838</b>	green	10,0	10

Dimensions and specifications may be changed without prior notice.

### Characteristics

- Drag Chain suitable
- Bending radius 7,5 x cable outerdiameter maximum
- Moving speed 180 m/min maximum
- Movement distance 6 m maximum
- Acceleration 5 m/s<sup>2</sup> maximum
- Cycles maximum 10 Mio.
- Temperature range from -40°C to +80°C
- Transmission rate maximum 100 Mbit/s
- Transmission distance maximum 50 m from the Hub to the receiver
- Suitable for the „Light-Duty“ range

### Options

We also can deliver other cable length, cross-over cables or other types of plugs.



## Type

## Patch Cable RJ45 LAN-Industry PHOENIX Variosub IP20, Drag Chain

### Cable

Designation:  
Sheath material:  
Frequency:

LAN industry 4x1x0,15  
PUR  
up to 100 MHz

### Plug

Push-on connector type 1:  
Push-on connector type 2:  
System type:  
Pin assignment:

RJ45-connector IP20  
RJ45-connector IP20  
Phoenix Variosub IP20  
1:1 acc. to TIA/EIA 568 B

### Flame proof

acc. to IEC 60332-1-2

### Oil-resistant

Acc. to EN60811-2-1

### Norms and standards

Components of HELUKAT® CONNECTING SYSTEMS® to 100 MHz acc. Categorie 5, ISO 11801 1st Edition, EN 50173-3 and EIA/TIA 568 B. Support the "IAONA Industrial Ethernet Guide" Release 4.0.

### Preferred types

Part no.	Sheath colour	Length in metres	Unit
<b>801326</b>	green	0,5	10
<b>801327</b>	green	1,0	10
<b>801328</b>	green	2,0	10
<b>801329</b>	green	3,0	10
<b>801330</b>	green	5,0	10
<b>801331</b>	green	10,0	10

Dimensions and specifications may be changed without prior notice.

### Characteristics

- Drag Chain suitable
- Bending radius 7,5 x cable outerdiameter maximum
- Moving speed 180 m/min maximum
- Movement distance 6 m maximum
- Acceleration 5 m/s<sup>2</sup> maximum
- Cycles maximum 10 Mio.
- Temperature range from -40°C to +80°C
- Transmission rate maximum 100 Mbit/s
- Transmission distance maximum 30 m from the Hub to the receiver
- Suitable for the „Light-Duty“ range.

### Options

We also can deliver other cable length, cross-over cables or other types of plugs.



## Type

**USB 2.0 A patch cable, industrial USB – Drag Chain application.**

## Cable

Designation: USB 2.0 shielded cable PUR, up to 5,0m  
Sheath material: PUR  
Frequency: up to 400 MHz

## Plug

Push-on connection 1: USB A  
Push-on connection 2: USB A

## Flame proof

Acc. to IEC 60332-1-2

## Norms and standards

HELUKABEL® CONNECTING SYSTEMS® system components to 400 MHz in compliance with USB 2.0 Standard. Suitable for applications such as image processing (e.g. surveillance cameras), metrology and control technology.

## Preferred types

Part no.	Sheath colour	Length in metres	Unit
<b>802464</b>	violet	0,5	10
<b>802465</b>	violet	1,0	10
<b>802466</b>	violet	2,0	10
<b>802467</b>	violet	3,0	10
<b>802468</b>	violet	5,0	10

Dimensions and specifications may be changed without prior notice.

## Characteristics

- Suitable for use as a patch cable in harsh environments
- Suitable for Drag Chain and other constantly moving applications
- Application temperature from -20°C to +60°C
- High-speed data transmission rate to max. 480 Mbit/s
- 5.0m maximum transmission distance to terminal device.
- Suitable for light duty applications.

## Options

Naturally, we also offer other lengths and connector types for IP applications on request.





## Type

### Cable

Designation:  
Sheath material:  
Frequency:

LAN industry 4x2x0,15  
PUR  
up to 100 MHz

### Plug

Push-on connector type 1:  
Push-on connector type 2:  
Pin assignment:

M12-Connector bush shielded  
M12-Buchse bush shielded  
D-coded according to DKE/IEC 61076-2-101

### Flame proof

acc. to IEC 60332-1-2

### Oil-resistant

Acc. to EN60811-2-1

### Norms and standards

Components of HELUKAT® CONNECTING SYSTEMS® to 100 MHz acc. Categorie 5, ISO 11801 1st Edition. Plug according IEC 61076-2-101-A1. Support the "IAONA Industrial Ethernet Guide" Release 4.0.

### Preferred types

Part no.	Sheath colour	Length in metres	Unit
<b>800800</b>	green	0,3	10
<b>800801</b>	green	1,0	10
<b>800802</b>	green	2,0	10
<b>800803</b>	green	3,0	10
<b>800804</b>	green	5,0	10
<b>800805</b>	green	10,0	10

Dimensions and specifications may be changed without prior notice.

### Characteristics

- Drag Chain suitable
- Bending radius 7,5 x cable outerdiameter maximum
- Moving speed 180 m/min maximum
- Movement distance 6 m maximum
- Acceleration 5 m/s<sup>2</sup> maximum
- Cycles maximum 10 Mio.
- Temperature range from -40°C to +80°C
- Transmission rate maximum 100 Mbit/s
- Transmission distance maximum 50 m from the Hub to the receiver
- PIN 1 = whog, PIN 3 = og, PIN 2 = whgn, PIN 4 = gn
- Suitable for the „Heavy-Duty“ range

### Options

We also can deliver other cable length, other pin codes or other types of plugs.



## Type

### Cable

Designation:  
Sheath material:  
Frequency:

LAN industry 4x2x0,15  
PUR  
up to 100 MHz

### Plug

Push-on connector type 1:  
Push-on connector type 2:  
Pin assignment:

M12-Connector bend shielded  
M12-Buchse bend shielded  
D-coded according to DKE/IEC 61076-2-101

### Flame proof

acc. to IEC 60332-1-2

### Oil-resistant

Acc. to EN60811-2-1

### Norms and standards

Components of HELUKAT® CONNECTING SYSTEMS® to 100 MHz acc. Categorie 5, ISO 11801 1st Edition. Plug according IEC 61076-2-101-A1. Support the "IAONA Industrial Ethernet Guide" Release 4.0.

### Preferred types

Part no.	Sheath colour	Length in metres	Unit
<b>800806</b>	green	0,3	10
<b>800807</b>	green	1,0	10
<b>800808</b>	green	2,0	10
<b>800809</b>	green	3,0	10
<b>800810</b>	green	5,0	10
<b>800811</b>	green	10,0	10

Dimensions and specifications may be changed without prior notice.

### Characteristics

- Drag Chain suitable
- Bending radius 7,5 x cable outerdiameter maximum
- Moving speed 180 m/min maximum
- Movement distance 6 m maximum
- Acceleration 5 m/s<sup>2</sup> maximum
- Cycles maximum 10 Mio.
- Temperature range from -40°C to +80°C
- Transmission rate maximum 100 Mbit/s
- Transmission distance maximum 50 m from the Hub to the receiver
- PIN 1 = whog, PIN 3 = og, PIN 2 = whgn, PIN 4 = gn
- Suitable for the „Heavy-Duty“ range

### Options

We also can deliver other cable length, other pin codes or other types of plugs.

# Patch Cables Profibus RS 485



M12/4-pole central IP67



## Type

## Patch Cable M12 for Profibus RS 485, Drag Chain

### Cable

Designation:  
Sheath material:  
Frequency:

Profibus 1x2x0,64 (strand) Drag Chain  
PUR  
up to 16 MHz

### Plug

Push-on connector type 1:  
Push-on connector type 2:  
Pin assignment:

M12-Connector bush shielded  
M12-Buchse bush shielded  
B-coded according to DKE/IEC 61076-2-101

### Oil-resistant

Acc. to EN60811-2-1

### Norms and standards

Components of HELUKABEL® CONNECTING SYSTEMS® for applications of Profibus RS 485. Plug according IEC 61076-2-101-A1. Support the EN50170.

### Preferred types

Part no.	Sheath colour	Length in metres	Unit
<b>800812</b>	violett similar RAL 4001	0,3	10
<b>800813</b>	violett similar RAL 4001	1,0	10
<b>800814</b>	violett similar RAL 4001	2,0	10
<b>800815</b>	violett similar RAL 4001	3,0	10
<b>800816</b>	violett similar RAL 4001	5,0	10
<b>800817</b>	violett similar RAL 4001	10,0	10

Dimensions and specifications may be changed without prior notice.

### Characteristics

- Drag Chain suitable
- Bending radius 10 x cable outerdiameter maximum
- Moving speed 200 m/min maximum
- Movement distance 5 m maximum
- Acceleration 5 m/s<sup>2</sup> maximum
- Cycles maximum 5 Mio.
- Temperature range from -25°C to +70°C
- Transmission rate maximum 3,6 re. 12 Mbit/s
- Segment distance maximum 100 m
- PIN 2 (A) = green, PIN 4 (B) = red, screen terminated on the nut and on PIN 5
- Suitable for the „Heavy-Duty“ range

### Options

We also can deliver other cable length, other pin codes or other types of plugs like SUB-D.

# Patch Cables Profibus RS 485



M12/4-pole angled IP67



## Type

### Cable

Designation:  
Sheath material:  
Frequency:

## Patch Cable M12W for Profibus RS 485, Drag Chain

Profibus 1x2x0,64 (strand) Drag Chain  
PUR  
up to 16 MHz

### Plug

Push-on connector type 1:  
Push-on connector type 2:  
Pin assignment:

M12-Connector bend shielded  
M12-Buchse bend shielded  
B-coded according to DKE/IEC 61076-2-101

### Oil-resistant

Acc. to EN60811-2-1

## Norms and standards

Components of HELUKABEL® CONNECTING SYSTEMS® for applications of Profibus RS 485. Plug according IEC 61076-2-101-A1. Support the EN50170.

## Preferred types

Part no.	Sheath colour	Length in metres	Unit
<b>800818</b>	violett similar RAL 4001	0,3	10
<b>800819</b>	violett similar RAL 4001	1,0	10
<b>800820</b>	violett similar RAL 4001	2,0	10
<b>800821</b>	violett similar RAL 4001	3,0	10
<b>800822</b>	violett similar RAL 4001	5,0	10
<b>800823</b>	violett similar RAL 4001	10,0	10

Dimensions and specifications may be changed without prior notice.

## Characteristics

- Drag Chain suitable
- Bending radius 10 x cable outerdiameter maximum
- Moving speed 200 m/min maximum
- Movement distance 5 m maximum
- Acceleration 5 m/s<sup>2</sup> maximum
- Cycles maximum 5 Mio.
- Temperature range from -25°C to +70°C
- Transmission rate maximum 3,6 re. 12 Mbit/s
- Segment distance maximum 100 m
- PIN 2 (A) = green, PIN 4 (B) = red, screen terminated on the nut and on PIN 5
- Suitable for the „Heavy-Duty“ range

## Options

We also can deliver other cable length, other pin codes or other types of plugs like SUB-D.



### Type

Protection classification (IP):  
System type:

Category:

20 Harting IP20 Industrial 4P	20 standard central	67 Phoenix Variosub IP67	20 standard angled
5	5	5	5

### Technical details

Connection type:  
core diameter:

cable diameter min.:  
cable diameter max.:  
Suitable for circular cable:  
Suitable for flat cable:  
Suitable for stranded conductor:  
Suitable for solid conductor:  
Operating temperature range min.:  
Operating temperature range max.:

Crimp AWG 22-24 (stranded) and AWG 22-23 (massive)	Crimp AWG 22 - 26 (stranded + massive)	Crimp AWG 24-26 (stranded)	Crimp AWG 22 - 26 (stranded + massive)
6,4	4,5	5,0	4,5
6,9	8,1	8,5	8,1
yes	yes	yes	yes
no	no	no	no
yes	yes	yes	yes
yes	yes	yes	yes
-40°C	-20°C	0°C	-20°C
+70°C	+70°C	+70°C	+70°C

Part no.:

<b>800986</b>	<b>802920</b>	<b>801318</b>	<b>804234</b>
---------------	---------------	---------------	---------------

Packing unit:

<b>10</b>	<b>10</b>	<b>10</b>	<b>10</b>
-----------	-----------	-----------	-----------

Dimensions and specifications may be changed without prior notice.

### Application

RJ45 plug connectors in accordance with EN50173-1 suitable for industrial Ethernet implementation. Available as IP20 or IP67/50 version. Technical details:

- Plug geometry: in accordance with IEC 60603-7 (RJ45).
- Suitable for light-duty or heavy-duty applications (depending on the plug type).

### Included in delivery

RJ45-plug/ M12-plug, housing and assembly instructions.

### Options

We also deliver other brandes or connector systems as M12 for industrial applications, on request.

NEW



### Type

Protection classification (IP):  
System type:

Category:

20 standard central 5	20 standard angled 5	20 standard central 5	20 standard angled 6	20 standard angled 5	20 standard central 6
--------------------------------	-------------------------------	--------------------------------	-------------------------------	-------------------------------	--------------------------------

### Technical details

Connection type:

core diameter:

cable diameter min.:

cable diameter max.:

Suitable for circular cable:

Suitable for flat cable:

Suitable for stranded conductor:

Suitable for solid conductor:

Operating temperature range min.:

Operating temperature range max.:

insulation displacement connector (IDC) AWG 22-24 (stranded)	insulation displacement connector (IDC) AWG 22-24 (stranded + solid)	insulation displacement connector (IDC) AWG 22-27 (stranded + solid)	insulation displacement connector (IDC) AWG 22-27 (stranded + solid)	insulation displacement connector (IDC) AWG 22-27 (stranded + solid)	insulation displacement connector (IDC) AWG 22-27 (stranded + solid)
6,3	6,3	4,5	4,5	4,5	4,5
6,7	6,7	9,0	8,0	8,0	9,5
yes	yes	yes	yes	yes	yes
no	no	no	no	no	no
yes	yes	yes	yes	yes	yes
yes	yes	yes	yes	yes	yes
-20°C	-20°C	-40°C	-40°C	-40°C	-40°C
+70°C	+70°C	+70°C	+70°C	+70°C	+70°C

Part no.:

<b>805401</b>	<b>805402</b>	<b>805781</b>	<b>805784</b>	<b>805782</b>	<b>805783</b>
---------------	---------------	---------------	---------------	---------------	---------------

Packing unit:

<b>1</b>	<b>1</b>	<b>1</b>	<b>1</b>	<b>1</b>	<b>1</b>
----------	----------	----------	----------	----------	----------

Dimensions and specifications may be changed without prior notice.

### Application

RJ45 IP and plug connectors in accordance with PROFinet suitable for industrial Ethernet implementation. Available as 90° or 180° version.

### Included in delivery

RJ45-plug and assembly instructions.

### Options

We also deliver other brandes or connector systems for industrial applications, on request.



### Type

### Cage

Model:  
Number of poles:  
Contact design:  
Housing material:

### PROFIBUS connectors

Plug  
9  
male  
metalized plastic

### Technical details

Protection classification (IP): 20  
Suitable for core diameter: 0,64 mm  
max. transmission rate: 12  
max. current drain: 0,0125 A  
terminating impedance: yes  
Operating temperature range min.: 0°C  
Operating temperature range max.: +60°C

### Plug types

Part no.	Out-going cable	Pro-gramming inter-face	Dia-gnos-tics mode	Connection type	Suitable for cable structure	Suitable for core type	Dimensions in mm	Unit
802401	90°	-	-	Screwing terminal	-	solid and flexible	64 x 40 x 17	10
803845	90°	-	yes	Screwing terminal	-	solid and flexible	64 x 40 x 17	10
802402	90°	yes	-	Screwing terminal	-	solid and flexible	64 x 40 x 17	10
803844	90°	yes	yes	Screwing terminal	-	solid and flexible	64 x 40 x 17	10
802406	90°	-	-	Crimp	SK/FC	solid and flexible	72 x 40 x 17	10
803195	90°	-	yes	Crimp	SK/FC	solid and flexible	64 x 40 x 17	10
802407	90°	yes	-	Crimp	SK/FC	solid and flexible	72 x 40 x 17	10
803194	90°	yes	yes	Crimp	SK/FC	solid and flexible	64 x 40 x 17	10
803356	45°	-	-	Crimp	SK/FC	solid	95 x 70 x 17	10
803576	45°	-	-	Crimp	SK/FC	flexible	72 x 40 x 17	10
803357	45°	yes	-	Crimp	SK/FC	solid	72 x 40 x 17	10
803577	45°	yes	-	Crimp	SK/FC	flexible	72 x 40 x 17	10
802403	35°	-	-	Screwing terminal	-	solid and flexible	54 x 40 x 17	10
802404	35°	yes	-	Screwing terminal	-	solid and flexible	54 x 40 x 17	10
802405	axial	-	-	Screwing terminal	-	solid and flexible	68 x 39,5 x 17	10
803208	axial	-	-	Crimp	SK/FC	solid and flexible	70 x 35 x 17	10

Dimensions and specifications may be changed without prior notice.

### Application

The compact design of the bus connectors from the series HELUKABEL® CONNECTING SYSTEMS makes them suitable for use in nearly all Siemens CPU types. A slide switch sets whether the connector will be used as a node or end of segment. The switch can also be operated when the connector is plugged. The switch setting is clearly visible.

### Included in delivery

SUB-D plug 9 poles, housing and assembly instructions.



## Type

### Cage

Model:  
Contact design:  
Housing material:

Adaptor  
Sub-D / M12  
metalized plastic

### Technical details

Protection classification (IP): 20  
max. transmission rate: 12  
max. current drain: 0,0125 A  
terminating impedance: yes  
Operating temperature range min.: -25°C  
Operating temperature range max.: +85°C

### Plug types

Part no.	Out-going cable	PG-Connection Jack	Diagnos-tics mode	Connection type	Dimensions in mm	Unit
<b>805194</b>	90°	-	-	M12	70 x 41 x 17	10
<b>805195</b>	90°	yes	-	M12 + Sub-D	70 x 41 x 17	10
<b>805709</b>	90°	yes	yes	M12 + Sub-D	70 x 41 x 17	10

Dimensions and specifications may be changed without prior notice.

## Application

PROFIBUS adaptor Sub-D / M12 will be used for interconnection with harnessed M12 cables. This will avoid interconnection failures and the time for installation is reduced to a minimum. This adaptor has two M12 interfaces and integrated termination resistors which can be selected under installed condition. The housing is metallized for an improved EMV resistance. Available with and without PG connector (Sub-D interface on the backside) and status LED's. orange = status of termination resistor  
green = activity of bus  
blue = participation on bus traffic  
The PROFIBUS adaptor has an enhanced temperature range of -25°C till +85°C (acc. UL test parameter +60°C)

## Included in delivery

Sub-D / M12 Adaptor

## Options

We also deliver connectors for other systems like CAN-Bus, DeviceNet or Interbus on request.





Fibre pigtails

Fibre optic wiring boxes

Multimode fibres

Industrial Ethernet SCdx-MM Outlets

DIN rail

HCS-fibre connection-cable

Splice boxes



# ■ FIBER OPTIC CONNECTION TECHNICS

Designation	Page
<b>Connection Technic - Office</b>	
Fibre optic Plug & Adapter overview	290
Pre-assembled fibre optic cables	292
MTP® / MPO – Plug and Play	296
19" splice boxes, telescope, full equipment	298
19" splice boxes, telescope partially configured with couplings	299
Mini-Wallmount Cabinet	300
Mini-Wallmount Cabinet splicing	301
Fibre-optic wiring boxes, in-wall installation	302
Fibre-optic plugs, fibre-optic couplings	303
Fibre pigtails	304
Fibre-optic connection-cable (jumper cable)	306
Fibre-optic Consumption material	308
Rubber cable reel with HELUCOM® fibre optic mobile cable	309
Fibre optic burial sleeves	310
Fibre optic Mast-Hood-Sleeves	311
Fittings for metal-free aerial cable (ADSS)	312
Suspension rods for span length <80m	313
Suspension rods for span length 80-150m	314
Suspension rods for span length 150-350m	316
<b>Connection Technic - Industry</b>	
POF/HCS connection technology	320
DIN rail distribution panels, modular	321
Fibre Optic DIN RAIL splicebox vertical	322
Industrial Ethernet outlet, metall IP67	323
Industrial Ethernet outlet plastic IP 65	324
Fibre optic top-hat rail installation data outlets	325
Plastic-fibre connection-cable (jumper cable), I-V2Y 1P 980/1000µm	326
HCS-fibre connection-cable (jumper cable), I-V(ZN)HH 2K 200/230µm	327
Industry fibre-optic plugs for POF, HCS and multimode fibres	328

# ■ FIBRE OPTIC PLUG & ADAPTER OVERVIEW

## ST plug



- Ceramic ferrule
- Available for single mode or multi-mode

## ST adapter



- Ceramic ferrule
- Available for single mode or multi-mode

## SC/SCdx plug



- Ceramic ferrule
- Normal cross section or 8° diagonal cross section (single mode only)
- Available for single mode or multi-mode

## SC/SCdx adapter



- Ceramic ferrule
- Normal cross section or 8° diagonal cross section (single mode only)
- Available for single mode or multi-mode

## LC plug



- Ceramic ferrule
- Available for single mode or multi-mode

## LC adapter



- Ceramic ferrule
- Available for single mode or multi-mode

## E-2000 plug



- Ceramic ferrule
- Normal cross section or 8° diagonal cross section (single mode only)
- Available for single mode or multi-mode

## E-2000 adapter

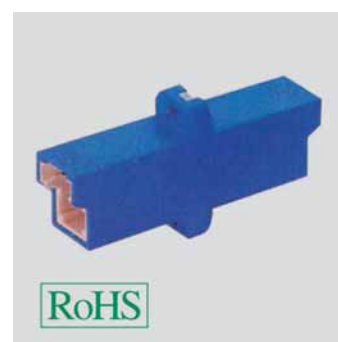

- Ceramic ferrule
- Normal cross section or 8° diagonal cross section (single mode only)
- Available for single mode or multi-mode

### DIN plug



RoHS

- Ceramic ferrule
- Available for single mode or multi-mode

### DIN adapter



RoHS

- Ceramic ferrule
- Available for single mode or multi-mode

### MTRJ Plug



RoHS

- Ceramic ferrule
- Available for single mode or multi-mode

### MTRJ adapter



RoHS

- Ceramic ferrule
- Available for single mode or multi-mode

### FC PC plug



RoHS

- Ceramic ferrule
- Normal cross section or 8° diagonal cross section (single mode only)
- Available for single mode or multi-mode

### FC PC adapter



RoHS

- Ceramic ferrule
- Normal cross section or 8° diagonal cross section (single mode only)
- Available for single mode or multi-mode

### F-SMA plug



RoHS

- Ceramic ferrule
- Available for single mode or multi-mode

### F-SMA adapter



RoHS

- Ceramic ferrule
- Available for single mode or multi-mode

## ■ PRE-ASSEMBLED FIBRE OPTIC CABLES

No special knowledge or tools are needed to install HELUCOM® pre-assembled fibre optic cables. The cable is pre-assembled and can be connected immediately after it has been laid. As a result, the installation process actually comprises nothing more than laying the cable itself. In the distributor bodies, the fibres from the loose-tube cable are conducted through the individual simplex cables without splicing. The simplex cables are terminated using pre-assembled plugs. Included in delivery is a plug

shield that protects the plugs, simplex cables and distributor body while the cable is being laid. The pulling aid is connected to the pull cable. As a result, it is possible to lay the cable together with the pre-assembled distributor just as you would lay a standard cable. The benefits of pre-assembled and pre-assembled cables are easy to see: The fibre optic cables are cut to the desired length, and the fibres are glued to different plug models in a clean and dust-free environment.

### Features:

#### Applications:

1. Outdoor wiring
2. Indoor wiring

#### Cable types:

- Zipcords with halogen-free outer jacket
- Breakout cables with halogen-free outer jacket
- Mini breakout cables with halogen-free outer jacket
- Fibre optic cables with central / stranded loose-tube cable
- Plastic fibre cables (POF)

#### Fibre types:

- E9/125 µm
- G50/125 µm
- G62,5/125 µm
- 200/230 µm
- 980/1000 µm

#### Plug systems:

- ST, SC, SCdx, LC, MTRJ, E-2000, DIN, FDDI, FC-PC and F-SMA

#### Additional pre-assembled kits:

- Pulling aid
- Pulling tube
- Core coding

### Pre-assembled fibre optic cables



**01** The pre-assembled loose-tube cable together with distributor body and pulling protection as it appears just before shipment. Depending on the length of the cable, the cable can be shipped as a ring or on a disposable shipping reel.



**02** Detailed view form the end of the cable with pulling aid.



**03** Detailed view of the robust cast distributor body. The distributor body is equipped with a compatible plastic gland for installation in splice boxes. In addition, the system can be reused in a new installation.

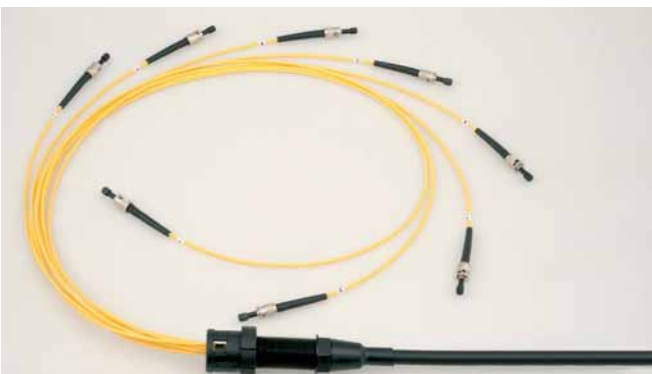

**04** Mini loose-tube cables designed to allow easy insertion into prepared splice boxes. In addition, the mini loose-tube cables are number-coded.



**05** Glass fibre splice box used as cable end enclosure for multi-core fibreoptic cables in 19" cabinets. The splice box is particularly suitable as a connecting unit for our pre-fabricated fibre-optic grooved cables.

# PRE-ASSEMBLED FIBRE OPTIC CABLES

Matrix Distributor bodies				
Designation	Figure	Top view		
		compact fibre	empty fibre	
<b>WKOM-01</b>				
<b>WKOM-02</b>				
<b>WKOM-03</b>				
<b>WKOM-04</b>				
<b>WKOM-05</b>				
Designation	Figure	Top view		
<b>WKOM-100</b>				
<b>WKOM-101</b>				
<b>WKOM-102-4</b>				
<b>WKOM-102-5</b>				
Cable allocation				
Designation	Figure	Top view		
<b>WKOM-105</b>				
<b>WKOM-106</b>				
<b>WKOM-107</b>				



	Compact fibre	Empty fibre	Thread	Fibre optic cable	Allocation table			
	max. number	max. number	type	max $\varnothing$ [mm]	length [mm]	D [mm]	d <sub>A</sub> [mm]	d <sub>I</sub> [mm]
	24	-	PG21	12	80	39	34	28
	12	-	PG16	12	80	34	28	23
	4	12	PG11	10	66	29	26	18,5
	4	12	-	10	35	17	-	-
	4	4	-	5	29	12	-	-
	Thread	Cable A	Cable B	Cable B	Allocation table			
	type	max $\varnothing$ [mm]	number	$\varnothing$ [mm]	Length [mm]	D [mm]	d <sub>A</sub> [mm]	d <sub>I</sub> [mm]
	PG16	12	2	6	80	34	28	23
	PG16	12	3	6	80	34	28	23
	PG21	12	4	8	80	39	34	28
	PG21	12	5	6	80	39	34	28
	Thread	Cable A	Cable B	Cable B	Allocation table			
	type	max $\varnothing$ [mm]	number	$\varnothing$ [mm]	Length [mm]	D [mm]	d <sub>A</sub> [mm]	d <sub>I</sub> [mm]
	-	14	2	12	110	-	18	14
	-	10	2	8	100	-	14	10
	-	8	2	6	100	-	12	8

## ■ MTP® / MPO – PLUG AND PLAY IN THE DATA PROCESSING CENTRE OF THE FUTURE

In data processing centres, height units in the rack as well as space along the cable routes are highly valuable. For fibre optic connections, the MTP® system (see IEC61754-7 and TIA/EIA 604-5) is an attractive option. With trunk cables, which bundle 12 to 24 fibres in a single connector, it is possible to implement a cabling structure that is flexible and future-proof.

(Refer to standard ISO11801 as well as EN50173-5). The trunk cable, which has a nominal diameter of 3.5 mm (4.5 mm in the case of 24 fibres), connects two modular inserts stowed in a 1 HE carrier frame. With push-pull technology, the plug of the

trunk cable is quickly and reliably connected with the module. The MTP® system from HELUKABEL® can be used to implement up to 96 fibres in a single height unit. In theory, this means that with 48 height units available, it is possible to manage up to 4608 fibres. With LC, SC, and ST connectivity, almost every connector preference can be met. MTP® products are factory pre-assembled and can be manufactured to order in any length. The fibre types OS1, OS2, and OM1 through 4 can be used for this system. Time-consuming, costly splicing work is a thing of the past with this plug and play system.



### MPO/MTP® module patch panel

- Carrier completely extractable
- 3 or 4 module slots
- up to 96 fibres per 1 HU possible
- 19" design, 1HU, 255 mm depth
- Colour RAL 9005



### MPO/MTP® cassette

- Available in 1HU or ½ HU.
- Lightweight aluminium housing
- with 12/24 LC, 12 SC, or 6 MTP® connections
- High packing density up to 12 LC duplex (24 fibres)
- Fibre types OS1(+APC), OM2, OM3, OM4



### Front panel 6x MPO/MTP®

- Lightweight aluminium front
- Painted in RAL 9005
- Push-Pull locking
- Fitted with 6 MTP® pass-thru connectors



### MPO/MTP® blanking plates

- for covering module slots not in use
- in 1 or ½ HU
- Fast push-pull locking

## ■ PRE-ASSEMBLED FIBRE OPTIC CABLES



### MPO/MTP®-trunk cables

- 12 or 24 fibres • Length to order
- Maximum performance due to factory quality assurance
- Diameter approx. 4.5mm (reinforced) or approx. 3.5mm
- Halogen-free
- Available as SM and OM3/4
- Fast, reliable push-pull locking
- MTP® male/female connectors possible



### MPO/MTP®-Fanout

- MTP® to LC/SC trunk cable
- 12 or 24 fibres • Pigtailed and total lengths to order
- Pigtail available as wire (0.9mm) or cable (2.0mm)
- Duplex clip possible
- Diameter 4.5 mm (reinforced) or 3.0 mm
- Halogen-free
- MTP® male/female connectors possible
- Fibre types OS1 (+APC), OM2, OM3, OM4

### MPO/MTP®-Fanout

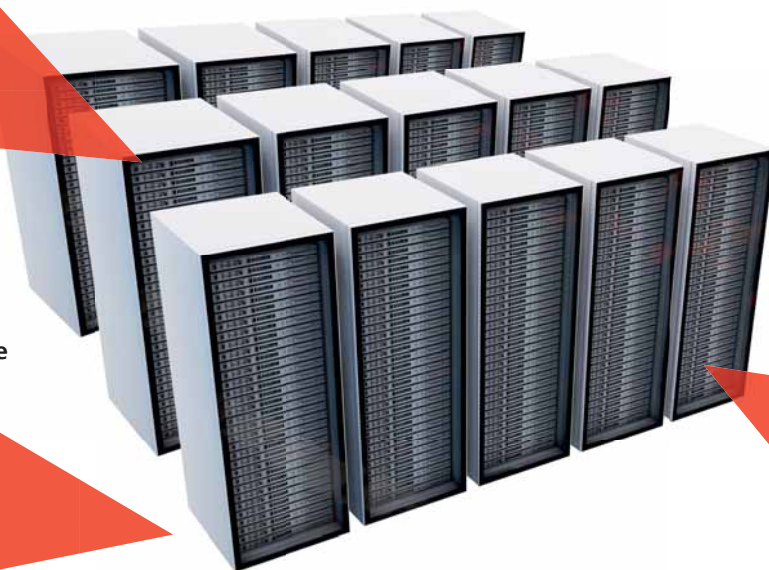

### MPO/MTP® Cassette



### MPO/MTP®-Trunk cable



### MPO/MTP® module patch panel



This is only a small excerpt from our product range in order to serve as a basis for planning. We will be happy to work with you to put together an offer based on your requirements.



## Type

## 19" splice boxes, telescope

### Cage

Housing material:  
Cover lock:  
Colour:

Steel sheet  
Fastening by means of screws  
Grey similar to RAL 7035

### Equipment

Full  
Couplers  
Pigtails

### Dimensions

Number of height modules (HM):  
Fastening dimensions:  
Width:

1  
19"  
225 mm

### Preferred types

Part no.	Number of couplers	Type of coupler	Fibre type	Unit
801164	4	ST	Multimode G50/125	1
802453	4	ST	Multimode G50/125 OM3	1
801165	8	ST	Multimode G50/125	1
802454	8	ST	Multimode G50/125 OM3	1
81354	12	ST	Multimode G50/125	1
802455	12	ST	Multimode G50/125 OM3	1
81355	12	ST	Multimode G62.5/125	1
82869	12	ST	Single-mode E9/125	1
81356	24	ST	Multimode G50/125	1
802456	24	ST	Multimode G50/125 OM3	1
81357	24	ST	Multimode G62.5/125	1
82870	24	ST	Single-mode E9/125	1
801166	2	SC duplex	Multimode G50/125	1
802457	2	SC duplex	Multimode G50/125 OM3	1
801167	4	SC duplex	Multimode G50/125	1
802458	4	SC duplex	Multimode G50/125 OM3	1
81358	6	SC duplex	Multimode G50/125	1
802459	6	SC duplex	Multimode G50/125 OM3	1
81359	6	SC duplex	Multimode G62.5/125	1
82871	6	SC duplex	Single-mode E9/125	1
81675	12	SC duplex	Multimode G50/125	1
802460	12	SC duplex	Multimode G50/125 OM3	1
81676	12	SC duplex	Multimode G62.5/125	1
82872	12	SC duplex	Single-mode E9/125	1
803145	2	LCdx	Multimode G50/125	1
803146	2	LCdx	Multimode G50/125 OM3	1
803147	4	LCdx	Multimode G50/125	1
803148	4	LCdx	Multimode G50/125 OM3	1
803149	6	LCdx	Multimode G50/125	1
803150	6	LCdx	Multimode G50/125 OM3	1
803151	6	LCdx	Multimode G62.5/125	1
803152	6	LCdx	Single-mode E9/125	1
803153	12	LCdx	Multimode G50/125	1
803154	12	LCdx	Multimode G50/125 OM3	1
803155	12	LCdx	Multimode G62.5/125	1
803156	12	LCdx	Single-mode E9/125	1
82873	12	E2000	Multimode G50/125	1
82874	12	E2000	Multimode G62.5/125	1
82875	12	E2000	Single-mode E9/125	1

Dimensions and specifications may be changed without prior notice.

### Application

Glass fibre splice boxes are used as cable end enclosures for multi-core fibre-optic cables in 19" cabinets.

Splice-Boxes partly equipped, Telescope



## Type

**19" splice boxes, telescope partially configured with couplings MM**

## Cage

Housing material:  
Cover lock:  
Colour:

Steel sheet  
Fastening by means of screws  
Grey similar to RAL 7035

## Equipment

Partially-configured  
Couplers

## Dimensions

Number of height modules (HM):  
Fastening dimensions:  
Width:

1  
19"  
225 mm

## Preferred types

Part no.	Number of couplers	Type of coupler	Unit
<b>801171</b>	4	ST	1
<b>801172</b>	8	ST	1
<b>801173</b>	12	ST	1
<b>801174</b>	24	ST	1
<b>801168</b>	2	SC duplex	1
<b>801169</b>	4	SC duplex	1
<b>801170</b>	6	SC duplex	1
<b>80996</b>	12	SC duplex	1
<b>803157</b>	2	LCdx	1
<b>803158</b>	4	LCdx	1
<b>803159</b>	6	LCdx	1
<b>803160</b>	12	LCdx	1

Dimensions and specifications may be changed without prior notice.

## Options

On request, different assembly variations, such as F-SMA, FC/PC, and DIN and/or diagonal cross section designs, are also available.

## Application

Glass fibre splice boxes are used as cable end enclosures for multi-core fibreoptic cables in 19" cabinets. The splice boxes described here are particularly suitable as a connecting unit for our pre-fabricated fibre-optic grooved cables.



### Type

### Cage

Housing material:  
Colour:

### Equipment

With front plate  
Maximum number of couplings/adapters:  
Number of couplings/adapters:  
With coupling/adapter:

### Dimensions

Width:

### Included in delivery

### Application

### Part no.

### Mini-Wallmount Cabinet

Steel sheet  
Grey similar to RAL 7035

8  
8  
Empty

54 mm

Housing with cover, lockable, 2 keys, 2 plastic expanding rivets, 4 openings with sealing strips for incoming and outgoing cables.

A maximum of 8 splice boxes or 4 splice boxes and one distributor plate can be installed. The distributor plate can be fastened using 2 plastic expanding rivets. Dimensions: W=320xH=280xD=54mm.

**802461**

Dimensions and specifications may be changed without prior notice.



### Type

### Mini-Wallmount Cabinet

### Cage

Housing material:  
Colour:

Steel sheet  
Grey similar to RAL 7035

### Equipment

With front plate  
Maximum number of couplings/adapters:  
Number of couplings/adapters:  
With coupling/adapter:

4  
4  
Empty

### Dimensions

Width:

55 mm

### Included in delivery

1 x distribution plate for 8 x ST or 8 x FC (D-hole) connectors and 1 x distribution plate for 4 x SC Duplex or 4 x LC 4-Way connectors

### Application

Cabinet with hinged cover, lockable, 2 keys, 2 dust-proof openings for incoming and outgoing cables that are fixed in place with cable ties. Space for a maximum of 4 splice trays or 1 splice tray and a distribution plate.  
Dimensions: Width = 265 x Height = 150 x Depth = 55mm.  
Included in delivery: 1 x distribution plate for 8 x ST or 8 x FC (D-hole) connectors and 1 x distribution plate for 4 x SC Duplex or 4 x LC 4-Way connectors.

### Part no.

**802462**

Dimensions and specifications may be changed without prior notice.



### Type

### Cage

Housing material:  
Colour:  
Outlet direction:  
Type of fastening:

### Fibre-optic wiring boxes, in-wall installation

Plastic  
Pure White similar to RAL 9010  
Angled  
Snap-in

### Equipment

Coupler  
Central plate  
Text box

### Dimension

50 x 50mm

### Preferred types

Part no.	Number of couplers	Type of coupler	Suitable for fibre type	Unit
<b>81072</b>	2	ST	Multi-mode	10
<b>81073</b>	4	ST	Multi-mode	10
<b>81074</b>	2	SC	Multi-mode	10
<b>81075</b>	4	SC	Multi-mode	10

Dimensions and specifications may be changed without prior notice.

### Options

On request, we also supply sockets in other configurations, such as three-way, to four-way, or six-way sockets. In addition, different codings can be supplied by means of colored identification buttons.

### Application

The fibre-optic wiring box forms the end element of the fibre-optic network at the workstation. From the wiring box, computers and peripheral devices are connected with cable connections (jumper cables). Depending on the version, the wiring box can be used in-wall mounting or top-mounting.





### Type

### Preferred types

### Fibre Optic connector

Part no.	Type	Suitable for fibre type	Unit
<b>80396</b>	ST	Multi-mode	50
<b>81062</b>	SC	Multi-mode	50
<b>81063</b>	SC duplex	Multi-mode	50
<b>800728</b>	SC duplex	Single-mode	50
<b>800725</b>	F-SMA	Multi-mode	50
<b>800727</b>	F-SMA	Single-mode	50
<b>800723</b>	LC	Multi-mode	50
<b>800726</b>	LC	Single-mode	50
<b>82025</b>	MT-RJ	Multi-mode	50
<b>800724</b>	FC	Multi-mode	50
<b>800720</b>	E2000	Single-mode	50
<b>800721</b>	DIN	Multi-mode	50

Dimensions and specifications may be changed without prior notice.

### Included in delivery

### Application

Fibre-optic plug

Fibre-optic plugs and couplings serve as links or removable connections for equipment outputs or distribution centers.

### Type

### Preferred types

### LWL-coupler

Part no.	Type	Suitable for fibre type	Unit
<b>800729</b>	SC / ST	Single-mode	50
<b>802252</b>	ST / ST	Multi-mode	50
<b>80605</b>	ST / ST	Single-mode	50
<b>81069</b>	SC / ST	Multi-mode	50
<b>805112</b>	SC / SC	Multi-mode	50
<b>81065</b>	SC / SC	Multi-mode	50
<b>800731</b>	SC / SC	Single-mode	50
<b>805111</b>	SC / SC	Single-mode	50
<b>81070</b>	SC duplex / ST	Multi-mode	50
<b>800730</b>	SC duplex / ST	Single-mode	50
<b>81066</b>	SC duplex / SC duplex	Multi-mode	50
<b>800732</b>	SC duplex / SC duplex	Single-mode	50
<b>82026</b>	MT-RJ / MT-RJ	Multi-mode	50
<b>800735</b>	LC / LC	Multi-mode	50
<b>800736</b>	LC / LC	Single-mode	50
<b>800733</b>	E2000 / E2000	Single-mode	50
<b>800737</b>	FC/PC / FC/PC	Multi-mode	50
<b>800738</b>	F-SMA / F-SMA	Multi-mode	50
<b>800734</b>	DIN / DIN	Multi-mode	50

Dimensions and specifications may be changed without prior notice.

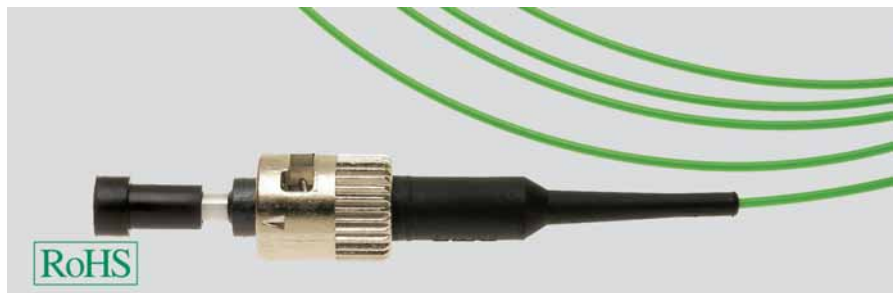

**Type**  
**Standard length**  
**Preferred types**

Plug type: ST



**Fibre pigtails**  
**2,0m**

Part no.	Fibre type	Sheath colour	Unit
<b>80457</b>	Multimode G50/125 OM2	Green	12
<b>80606</b>	Multimode G62.5/125	Blue	12
<b>81041</b>	Single-mode E9/125	Yellow	12

Plug type: SC



Part no.	Fibre type	Sheath colour	Unit
<b>81044</b>	Multimode G50/125 OM2	Green	12
<b>81045</b>	Multimode G62.5/125	Blue	12
<b>81046</b>	Single-mode E9/125	Yellow	12

Plug type: ST

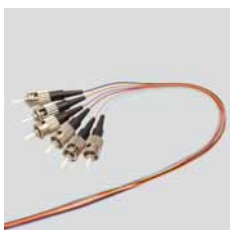

Part no.	Fibre type	Sheath colour	Unit
<b>805718</b>	Multimode G50/125 OM2	color coded	12
<b>805719</b>	Multimode G50/125 OM3	color coded	12
<b>805720</b>	Multimode G50/125 OM4	color coded	12
<b>805722</b>	Multimode G62.5/125	color coded	12
<b>805721</b>	Single-mode E9/125	color coded	12

Plug type: SC



Part no.	Fibre type	Sheath colour	Unit
<b>805723</b>	Multimode G50/125 OM2	color coded	12
<b>805080</b>	Multimode G50/125 OM3	color coded	12
<b>805724</b>	Multimode G50/125 OM4	color coded	12
<b>805725</b>	Multimode G62.5/125	color coded	12
<b>805110</b>	Single-mode E9/125	color coded	12

Continuation▶

Plug type:

LC

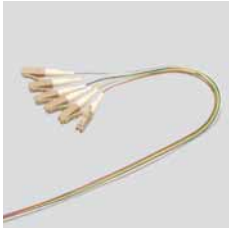

Part no.	Fibre type	Sheath colour	Unit
<b>805726</b>	Multimode G50/125 OM2	color coded	12
<b>805727</b>	Multimode G50/125 OM3	color coded	12
<b>805728</b>	Multimode G50/125 OM4	color coded	12
<b>805730</b>	Multimode G62.5/125	color coded	12
<b>805729</b>	Single-mode E9/125	color coded	12

Dimensions and specifications may be changed without prior notice.

## Application

Pigtails are used in glass fibre sets, such as splice boxes. 12 pigtails with fibrecoatings 900µ in a packing unit. Every packing unit contains an individual measurement protocol.

## Options

On request, different assembly variations, such as E2000, FC/PC, F-SMA or DIN, are also available. 8° or 9° diagonal cross sections are also manufactured with the corresponding plug types.

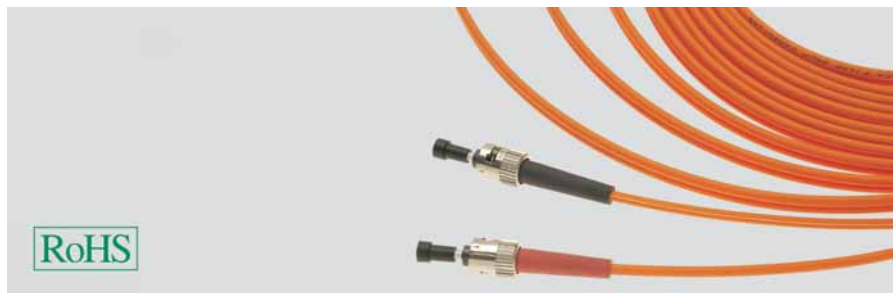

## Type Preferred types

Plug type: ST / ST



### Jumper cable I-VH 2x1 (glas fibre)

Part no.	Fibre type	Length in metres	Sheath colour	Unit
803161	Multimode G50/125 OM2	1	Orange	10
80983	Multimode G50/125 OM2	2	Orange	10
801175	Multimode G50/125 OM2	3	Orange	10
801176	Multimode G50/125 OM2	5	Orange	10
805796	Multimode G50/125 OM3	1	turquoise	10
802442	Multimode G50/125 OM3	2	turquoise	10
805797	Multimode G50/125 OM3	3	turquoise	10
805798	Multimode G50/125 OM3	5	turquoise	10
80636	Multimode G62.5/125	2	Orange	10
805799	Single-mode E9/125	1	Yellow	10
81043	Single-mode E9/125	2	Yellow	10
805800	Single-mode E9/125	3	Yellow	10
805801	Single-mode E9/125	5	Yellow	10

Plug type: SC duplex / ST



Part no.	Fibre type	Length in metres	Sheath colour	Unit
803163	Multimode G50/125 OM2	1	Orange	10
81053	Multimode G50/125 OM2	2	Orange	10
803164	Multimode G50/125 OM2	3	Orange	10
803165	Multimode G50/125 OM2	5	Orange	10
805790	Multimode G50/125 OM3	1	turquoise	10
802444	Multimode G50/125 OM3	2	turquoise	10
805791	Multimode G50/125 OM3	3	turquoise	10
805792	Multimode G50/125 OM3	5	turquoise	10
81054	Multimode G62.5/125	2	Orange	10
805793	Single-mode E9/125	1	Yellow	10
81055	Single-mode E9/125	2	Yellow	10
805794	Single-mode E9/125	3	Yellow	10
805795	Single-mode E9/125	5	Yellow	10

Plug type: SC duplex / SC duplex



Part no.	Fibre type	Length in metres	Sheath colour	Unit
803162	Multimode G50/125 OM2	1	Orange	10
81050	Multimode G50/125 OM2	2	Orange	10
801177	Multimode G50/125 OM2	3	Orange	10
801178	Multimode G50/125 OM2	5	Orange	10
805078	Multimode G50/125 OM3	1	turquoise	10
802443	Multimode G50/125 OM3	2	turquoise	10
805079	Multimode G50/125 OM3	3	turquoise	10
805712	Multimode G50/125 OM3	5	turquoise	10
81051	Multimode G62.5/125	2	Orange	10
800423	Single-mode E9/125	1	Yellow	10
81052	Single-mode E9/125	2	Yellow	10
800424	Single-mode E9/125	3	Yellow	10
805715	Single-mode E9/125	5	Yellow	10

Continuation▶

Plug type:

LC duplex / LC duplex

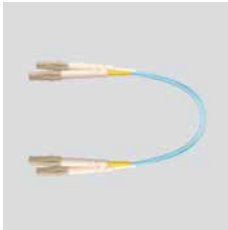

Part no.	Fibre type	Length in metres	Sheath colour	Unit
803166	Multimode G50/125 OM2	1	Orange	10
802447	Multimode G50/125 OM2	2	Orange	10
803167	Multimode G50/125 OM2	3	Orange	10
803168	Multimode G50/125 OM2	5	Orange	10
805076	Multimode G50/125 OM3	1	turquoise	10
802445	Multimode G50/125 OM3	2	turquoise	10
805077	Multimode G50/125 OM3	3	turquoise	10
805714	Multimode G50/125 OM3	5	turquoise	10
802449	Multimode G62.5/125	2	Orange	10
805045	Single-mode E9/125	1	Yellow	10
802451	Single-mode E9/125	2	Yellow	10
805046	Single-mode E9/125	3	Yellow	10
805717	Single-mode E9/125	5	Yellow	10

Plug type:

LC duplex / ST



Part no.	Fibre type	Length in metres	Sheath colour	Unit
803171	Multimode G50/125 OM2	1	Orange	10
802543	Multimode G50/125 OM2	2	Orange	10
803172	Multimode G50/125 OM2	3	Orange	10
803173	Multimode G50/125 OM2	5	Orange	10
805802	Multimode G50/125 OM3	1	turquoise	10
803174	Multimode G50/125 OM3	2	turquoise	10
805804	Multimode G50/125 OM3	3	turquoise	10
805803	Multimode G50/125 OM3	5	turquoise	10
803175	Multimode G62.5/125	2	Orange	10
805805	Single-mode E9/125	1	Yellow	10
803176	Single-mode E9/125	2	Yellow	10
805807	Single-mode E9/125	3	Yellow	10
805806	Single-mode E9/125	5	Yellow	10

Plug type:

LC duplex / SC duplex

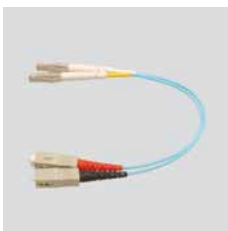

Part no.	Fibre type	Length in metres	Sheath colour	Unit
803169	Multimode G50/125 OM2	1	Orange	10
802448	Multimode G50/125 OM2	2	Orange	10
802545	Multimode G50/125 OM2	3	Orange	10
803170	Multimode G50/125 OM2	5	Orange	10
805074	Multimode G50/125 OM3	1	turquoise	10
802446	Multimode G50/125 OM3	2	turquoise	10
805075	Multimode G50/125 OM3	3	turquoise	10
805713	Multimode G50/125 OM3	5	turquoise	10
802450	Multimode G62.5/125	2	Orange	10
802482	Single-mode E9/125	1	Yellow	10
802452	Single-mode E9/125	2	Yellow	10
801836	Single-mode E9/125	3	Yellow	10
805716	Single-mode E9/125	5	Yellow	10

Dimensions and specifications may be changed without prior notice.

## Application

### Options

Cable connections by HELUCOM® are used for wiring terminals.

On request, different assembly variations, such as E2000, FC/PC, F-SMA or DIN, are also available. 8° or 9° diagonal cross sections are also manufactured with the corresponding plug types.



## Preferred types

Part no.	Type	Unit
<b>80307</b>	SPLICING CASSETTE	10
<b>81365</b>	SPLICE HOLDER "SHRINK"	100
<b>81364</b>	SPLICE HOLDER "CRIMP"	100
<b>81363</b>	CASSETTE COVER	10
<b>81362</b>	SHRINK-ON SPLICE PROTECTOR	100
<b>80309</b>	CRIMP SPLICE PROTECTOR	100

Dimensions and specifications may be changed without prior notice.

## Options

On request, we also supply special consumables that are not covered by our high-quality types.



## Type

**Rubber cable reel with HELUCOM® fibre optic mobile cable**

## Drum

Equipment:

## Rubber

with supporting frame

## Cable

Description:  
sheath colour:

Fibre-optic cable, mobile, trailing  
Orange

Flame proof

VDE 0482-332-1-2

## Plug

System type:  
Protective grommet:  
APC version:

office connector  
Plugged  
no

## Norms and standards

Components of HELUCOM CONNECTING SYSTEMS® according actual standards. Meet the standard IEC 60794-1-2 F5 and E6. Also they realize the optical data acc. OM1, OM2 and ITU-T G.652.

## Preferred types

Part no.	Fibre category	Fibre count	Plug 1	Plug 2	Cable length m
<b>802223</b>	Multimode G50/125	4	ST	ST	500,0
<b>802226</b>	Multimode G62,5/125	4	ST	ST	500,0
<b>802229</b>	Single-Mode E9/125	4	ST	ST	500,0
<b>802224</b>	Multimode G50/125	4	SC duplex	SC duplex	500,0
<b>802227</b>	Multimode G62,5/125	4	SC duplex	SC duplex	500,0
<b>802230</b>	Single-Mode E9/125	4	SC duplex	SC duplex	500,0
<b>802225</b>	Multimode G50/125	4	LC duplex	LC duplex	500,0
<b>802228</b>	Multimode G62,5/125	4	LC duplex	LC duplex	500,0
<b>802231</b>	Single-Mode E9/125	4	LC duplex	LC duplex	500,0

Dimensions and specifications may be changed without prior notice.

## Characteristics

Rubber cable reel with 4 fibre optic jacks and fibre optic plugs. Suitable for mobile use on site, for example for meetings, TV-Transmissions, Fairs, etc.. Everywhere when there is a need for a removable cable connection. Usable for flexible and fixed installation cabling.

## Options

We also can deliver other cable length, other fibre types or other types of plugs.

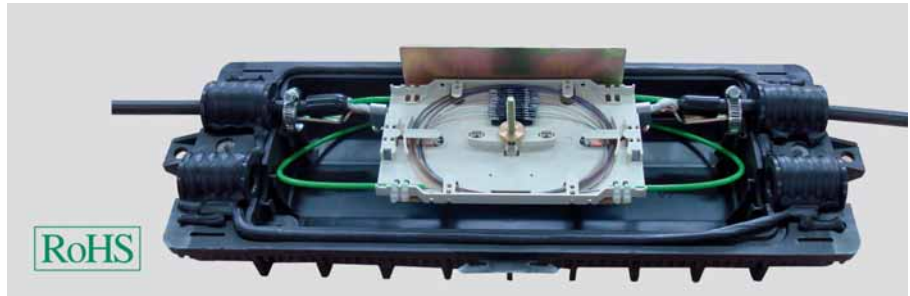

## Preferred types

Part no.	Type	Unit
<b>802936</b>	Fibre Optic Burial Sleeve 24 Fibre capacity	1
<b>804300</b>	Fibre Optic Burial Sleeve 48 Fibre capacity	1

Dimensions and specifications may be changed without prior notice.

## Application

This fiber optic sleeve is suitable for use with up to 48 fibers and is therefore suitable for most applications in optical distribution networks. The fiber optic sleeve is to chemical and mechanical influences in all fields of optical crosslinked, resistant. In the sleeve set are all included for the complete assembly of the sleeve parts required. The type and number of splice trays are selected according to the particular application. The joint consists of two plastic parts and mastic sealants. The wedge slide closure enables easy and fast closing the outdoor sleeve. Through the closure mechanism short installation times and simple open and closed again be made possible.





## Preferred types

Part no.	Type	Unit
<b>804301</b>	Mast- Hood-Sleeves 48 Fibre capacity	1
<b>804302</b>	Mast- Hood-Sleeves 144 Fibre capacity	1

Dimensions and specifications may be changed without prior notice.

## Application

Mast-, tower or hood sleeves are designed for underground laying and mounting in stacks and on masts. These types of sleeves are used in a vertical position – all ingoing and outgoing cables are feeded at the bottom. The special construction ensures a maximal protection against environmental conditions. The family of hood sleeves contains 24 to 144 shrinking splices in which max. 12 fiber optic splices lead to a hinged splice cassette. These sleeves are used in long distance data transmission and in the backbone-area of big companies. Access to single fibers is possible trough operation by the hinged splice cassettes, which ensures an undisturbed function of the cables.

## ■ FITTINGS FOR METAL-FREE AERIAL CABLE

HELUCOM® ADSS fittings are designed to meet the special requirements of optical fibre aerial cable. Our customers, such as electricity supply companies, erection firms, railway and telecommunication companies, receive with the beginning of the planning technical solutions with optimized fittings and the best technical solutions from the planning stage through to optimized fittings and state-of-the-art damping concepts for durable and reliable operation of their transmission lines.

HELUCOM® ADSS fittings are designed to meet the increased demands on optical fibre aerial cables. Especially the helical fittings even exceed the necessary mechanical requirements. The range of HELUCOM® ADSS helical fittings includes a suitable solution for every application.

The method of operation of helical fittings has been adapted from nature and is based on the principle of a cable puller. The inside diameter of the unloaded helical rods is slightly smaller than the outside diameter of the optical fibre aerial cable.

Installing these preformed helical rods creates a spring tension and sets up the mechanical preloaded contact. A special feature of this design is that the helical fitting distributes the forces acting on the cable uniformly over a large area of the cable, which avoids mechanical loads on the optical fibres.

The advantages of HELUCOM® ADSS helical fittings include easy installation and low load on the cable. The helical rods can be installed without tools and installation faults are impossible. The installation can be inspected visually from the ground level.

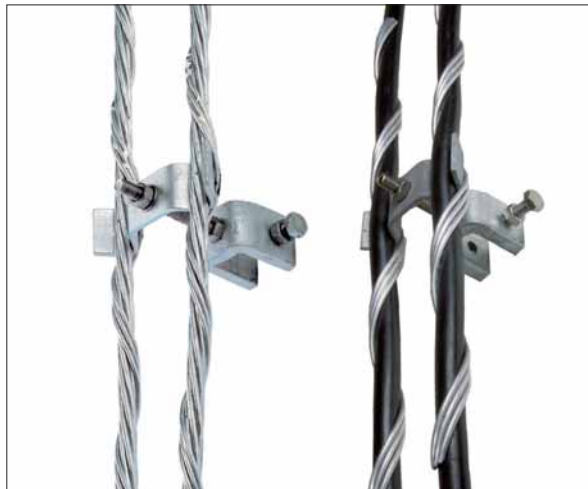
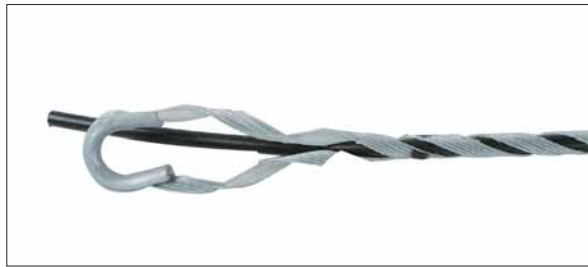

# Fittings for metal-free optical fibre aerial cables (ADSS)

Span length < 80 m

HELUCOM®

## Suspension Fittings



### Suspension rods

#### Application

HELUCOM® ADSS Suspension rods consisting of thimble, LG- and TG-helical rods are designed for vertical loads up to 1kN. They are used for span lengths up to 80 m approximately. The TG-suspension rods with the preformed loop is the supporting accessory. The shorter and straight LG-supporting rods are only used for stiffening the area round the suspension point. The loop of the fitting is stabilized and protected against abrasion with a ring type thimble.

#### Details

Designation	Material	Part no.	Unit
Suspension rod (TG) 80m/ ADSS 6L	Steel	<b>805731</b>	1
Supporting rod (LG) 80m/ ADSS 6L	Steel	<b>805732</b>	1
Thimble 80m/ ADSS 6L	Steel	<b>805733</b>	1

Dimensions and specifications may be changed without prior notice.

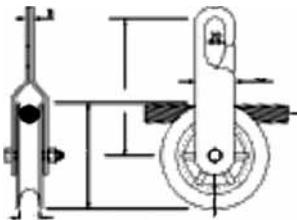

### Suspension pulleys with/ without protection rods

#### Application

HELUCOM® ADSS Suspension pulleys are used for suspension of ADSS cables. The suspension pulleys benefit from the fact that in case of a tree falling in the span length the ADSS cable is not destroyed. This has no influence on the communication line. To avoid high compression forces at the point of contact between cable and suspension pulleys the use of protection rods is recommended.

#### Details

Designation	Material	Part no.	Unit
Suspension pulley ADSS 6L/ 9L	Steel	<b>805747</b>	1
Protection rod ADSS 6L/ 9L	Steel	<b>805748</b>	1

Dimensions and specifications may be changed without prior notice.

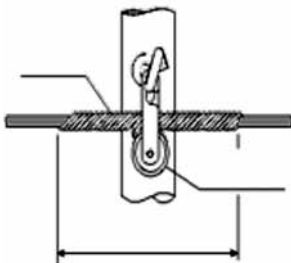

### Suspension pulley with helical rod

#### Application

HELUCOM® ADSS Suspension pulleys with helical rods are used for suspension of ADSS cables. They are designed for span lengths up to 150 m approximately and tensile forces up to 2,5 kN.

#### Details

Designation	Material	Part no.	Unit
Suspension pulley with helical rod ADSS 6L/9L	Steel	<b>805749</b>	1

Dimensions and specifications may be changed without prior notice.

## Tension Fittings

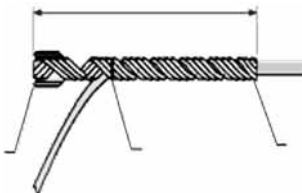

### Helical Dead Ends

#### Application

HELUCOM® ADSS Helical dead ends are designed for the full tensioning of ADSS cables in short span lengths up to 80 m/ 150m. The loop of the dead end can be protected against abrasion by a thimble. For short spans (up to approx. 80m) and small forces: The dead end is mounted on the cable starting at the black crossing mark. This leads to a long cable loop and a large bending radius of the cable. A thimble can be used in the loop of the dead end.

#### Details

Designation	Material	Part no.	Unit
Helical dead end (AG) ADSS 6L/9L	Steel	<b>805751</b>	1
Thimble ADSS 6L/9L	Steel	<b>805752</b>	1

Dimensions and specifications may be changed without prior notice.

# Fittings for metal-free optical fibre aerial cables (ADSS)

Span length 80 - 150 m

HELUCOM®

## Suspension Fittings



### Suspension rods

#### Application

HELUCOM® ADSS Suspension rods consisting of thimble, TG- and UTA-helical rods are designed for vertical loads up to 5kN. They are used for span lengths from 80m up to 150 m. The loop of the TG-suspension rods is stabilized and protected against abrasion by a ring type thimble. Protection rods are mounted under the suspension rods to protect the ADSS cable. They reduce radial forces in the cable and increase - due to the increased bending stiffness - the bending radius of the ADSS cable.

#### Details

Designation	Material	Part no.	Unit
Suspension rod (TG) 150m/ ADSS 9L	Steel	<b>805734</b>	1
Supporting rod (UTA) 150m/ ADSS 9L	Steel	<b>805735</b>	1
Thimble 150m/ ADSS 9L	Steel	<b>805736</b>	1

Dimensions and specifications may be changed without prior notice.

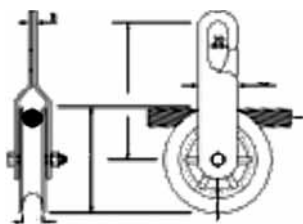

### Suspension pulleys with/ without protection rods

#### Application

HELUCOM® ADSS Suspension pulleys are used for suspension of ADSS cables. The suspension pulleys benefit from the fact that in case of a tree falling in the span length the ADSS cable is not destroyed. This has no influence on the communication line. To avoid high compression forces at the point of contact between cable and suspension pulleys the use of protection rods is recommended.

#### Details

Designation	Material	Part no.	Unit
Suspension pulley ADSS 6L/ 9L	Steel	<b>805747</b>	1
Protection rod ADSS 6L/ 9L	Steel	<b>805748</b>	1

Dimensions and specifications may be changed without prior notice.

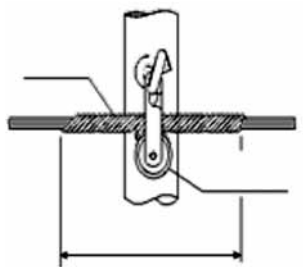

### Suspension pulley with helical rod

#### Application

HELUCOM® ADSS Suspension pulleys with helical rods are used for suspension of ADSS cables. They are designed for span lengths up to 150 m approximately and tensile forces up to 2,5 kN.

#### Details

Designation	Material	Part no.	Unit
Suspension pulley with helical rod ADSS 6L/9L	Steel	<b>805749</b>	1

Dimensions and specifications may be changed without prior notice.



### Vibration damper (AVIBRA)

#### Application

The purpose of HELUCOM® ADSS Avibra vibration dampers is to dissipate partly the wind power input on the ADSS cable to prevent critical cable stresses. The Avibra vibration damper is composed of a helically formed plastic rod. About one fifth of the overall length of the helix is of smaller diameter. This section is used to attach the damper and provides a completely reliable grip on the ADSS cable so that the damper will not slip even on slopes. The remaining length of the helix has no close contact to the cable. Due to differential motions between ADSS cable and Avibra damper, the ADSS cable vibrations are eliminated.

#### Details

Designation	Material	Part no.	Unit
Vibration damper (AVIBRA) 150m/ ADSS 9L	Plastic	<b>805753</b>	1

Dimensions and specifications may be changed without prior notice.

Continuation▶

# Fittings for metal-free optical fibre aerial cables (ADSS)

Span length 80 - 150 m

HELUCOM®

## Tension Fittings

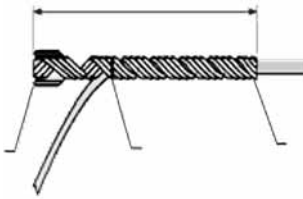

### Helical Dead Ends

#### Application

HELUCOM® ADSS Helical dead ends are designed for the full tensioning of ADSS cables in short span lengths up to 80 m/ 150m. The loop of the dead end can be protected against abrasion by a thimble.

For short spans (up to approx. 80m) and small forces: The dead end is mounted on the cable starting at the black crossing mark. This leads to a long cable loop and a large bending radius of the cable. A thimble can be used in the loop of the dead end.

#### Details

Designation	Material	Part no.	Unit
Helical dead end (AG) ADSS 6L/9L	Steel	<b>805751</b>	1
Thimble ADSS 6L/9L	Steel	<b>805752</b>	1

Dimensions and specifications may be changed without prior notice.

# Fittings for metal-free optical fibre aerial cables (ADSS)

Span length > 150 m

HELUCOM®

## Suspension Fittings



### LTA - Armour grip suspensions

#### Application

HELUCOM® ADSS armour grip suspension is used for the movable suspension of conductors and optical fibre aerial cables on suspension towers. The armour grip suspension is composed of a certain number of helically formed rods, a concave Neoprene insert consisting of two halves and a clamp body. The helical rods are placed on the Neoprene insert at the suspension point. This centre assembly is fixed by the clamp body which due to positive locking prevents axial displacement of the conductor.

#### Details

Designation	Material	Part no.	Unit
Armour grip suspension (LTA) 350m/ ADSS 16L	Aluminum alloy	<b>805756</b>	1
Shakle (for LTA) 350m/ ADSS 16L	Steel	<b>805757</b>	1

Dimensions and specifications may be changed without prior notice.

#### Characteristics

Other Materials:

Straps: Steel, h.d.g.

Bolt: Steel, h.d.g.

Insert: Neoprene



### Vibration damper (AVIBRA)

#### Application

The purpose of HELUCOM® ADSS Avibra vibration dampers is to dissipate partly the wind power input on the ADSS cable to prevent critical cable stresses. The Avibra vibration damper is composed of a helically formed plastic rod. About one fifth of the overall length of the helix is of smaller diameter. This section is used to attach the damper and provides a completely reliable grip on the ADSS cable so that the damper will not slip even on slopes. The remaining length of the helix has no close contact to the cable. Due to differential motions between ADSS cable and Avibra damper, the ADSS cable vibrations are eliminated.

#### Details

Designation	Material	Part no.	Unit
Vibration damper (AVIBRA) 350m/ ADSS 16L	Plastic	<b>805758</b>	1

Dimensions and specifications may be changed without prior notice.

## Tension Fittings



### Helical dead ends

#### Application

HELUCOM® ADSS helical dead ends are particularly designed for the full tensioning of metal-free optical fibre aerial cable in medium and long spans.

For long spans and high forces: The dead end is mounted on the cable starting at the red crossing mark. This leads to a short cable loop. Additional intermediate fittings for installation at the tower and a thimble are necessary. The use of protection rods is recommended. When selecting the helical dead ends the total diameter resulting out of the cable diameter plus two times the rod diameter of protection rods has to be taken into account.

#### Details

Designation	Material	Part no.	Unit
Helical dead end (AG) 350m/ ADSS 16L	Steel	<b>805775</b>	1
Thimble for helical dead end ADSS 16L	other	<b>805776</b>	1
Shakle (for AG) 350m/ ADSS 16L	Steel	<b>805777</b>	1

Dimensions and specifications may be changed without prior notice.

Continuation▶

# Fittings for metal-free optical fibre aerial cables (ADSS)

Span length > 150 m

HELUCOM®

## Protection rods

### Application

HELUCOM® ADSS URG-Protection rods are preferably made of steel, h.d.g. and shall protect the self supporting fibre optical aerial cables at tension sets. They are mounted beneath the helical dead end and spread the radial forces on the cable uniformly along the zone of contact. Especially on the cable at the loop-side of the helical dead end radial forces (depending on the tension force) can stress the optical part of the cable inadmissibly. This will cause high damping which results in a reduced data transmission or in the worst case an interruption.

### Details

Designation	Material	Part no.	Unit
Protection rod (URG) 350m/ ADSS 16L	Steel	<b>805778</b>	1

Dimensions and specifications may be changed without prior notice.

Industry Plugs POF / HCS / MM

Patch-Panels

POF/HCS F-SMA

HCS-fibre connection cable

Machine outlet IP65





# ■ FIBRE OPTICS CONNECTION COMPONENTS - INDUSTRY

<b>Designation</b>	<b>Page</b>
<b>Fiber optic connection Technic - Industry</b>	
POF/HCS connection technology	<b>320</b>
DIN rail distribution panels, modular	<b>321</b>
Fibre Optic DIN RAIL splicebox vertical	<b>322</b>
Industrial Ethernet outlet, metall IP67	<b>323</b>
Industrial Ethernet outlet plastic IP 65	<b>324</b>
Fibre optic top-hat rail installation data outlets	<b>325</b>
Plastic-fibre connection-cable (jumper cable), I-V2Y 1P 980/1000µm	<b>326</b>
HCS-fibre connection-cable (jumper cable), I-V(ZN)HH 2K 200/230µm	<b>327</b>
Industry fibre-optic plugs for POF, HCS and multimode fibres	<b>328</b>

# POF/HCS CONNECTION TECHNOLOGY

## POF-HFBR 4501/4511 HCS-HFBR 4521



- Simplex connector
- Plastic enclosure
- For POF and HCS
- Processing: crimping, grinding, polishing

## POF-TOCP 155/F05 HCS-TOCP/F05



- Simplex connector
- Plastic enclosure
- For POF and HCS
- Processing: crimping, grinding, polishing or hotplate

## POF-HFBR 4503/4513



- Simplex connector
- Plastic enclosure
- For POF
- Processing: crimp /latch

## POF-TOCP 255/F07 HCS-TOCP 255/F07



- Duplex connector
- Plastic enclosure
- For POF and HCS
- Processing: crimping, grinding, polishing or hotplate

## POF-HFBR 4533/4531



- Simplex connector
- Plastic enclosure
- For POF
- Processing: crimping, grinding, polishing

## POF/HCS F-SMA



- Simplex connector
- Metal enclosure
- For POF and HCS (2.2/3.6/6.0 mm)
- Processing: crimping, grinding, polishing

## POF-HFBR 4506



- Duplex connector
- Plastic enclosure
- For POF
- Processing: crimping, grinding, polishing

## POF/HCS ST



- Simplex connector
- Metal / plastic enclosure
- For POF and HCS (2.2/3.6 mm)
- Processing: crimping, grinding, polishing

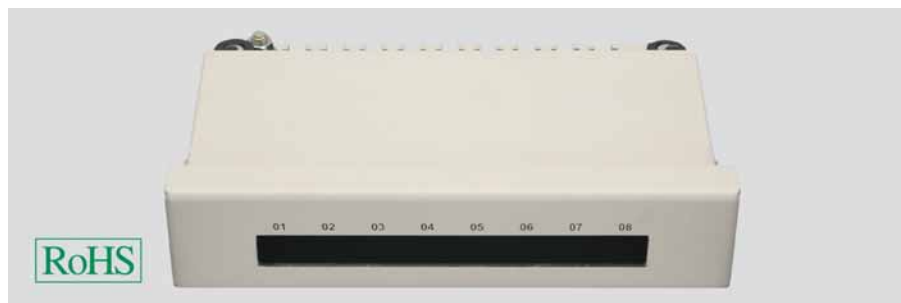

## Type

### Configuration

Housing material:  
Colour:  
Max. number of modules:  
Screen removal:  
Strain relief:  
Cover lock:

### Dimension

Width:  
Depth:  
Number of height modules (HM):

### Part no.:

### Packing unit:

With coupling/adaptor  
Connection type, exterior  
Connection type, internal  
Number of couplers  
Fibre type  
APC version  
Type:

### Part no.:

### Packing unit:

### Norms and standards

### Application

## Basic Panel

Steel plate, solid	Steel plate, solid
Grey similar to RAL 7035	Grey similar to RAL 7035
8	16
via continuous screening tape	via continuous screening tape
by means of cable straps	by means of cable straps
Quick-action twist lock	Quick-action twist lock

195 mm	195 mm
150 mm	150 mm
1	2

<b>801311</b>	<b>801304</b>
---------------	---------------

5	5
---	---

## Module

yes	yes	
ST	SC-Duplex	
ST	SC-Duplex	
1	1	
Multimode	Multimode	
N	N	
Modul for top-hat rail	Modul for top-hat rail	Modul for top-hat rail
installation patch panel, 2xST	installation patch panel, 2xSC	installation patch panel, blind
MM	MM	2ME

<b>801314</b>	<b>801315</b>	<b>801316</b>
---------------	---------------	---------------

10	1	10
----	---	----

HELUKAT® CONNECTING SYSTEMS® INDUSTRY individual system components, category 6 de-embedded (IEC 60603-7-5), ISO 11801 2nd Edition, EN 50173-1 2nd Edition, EIA/TIA 568-B.2-1 and EN 55022 (EMV).

As connection distribution unit for DIN rail installation e.g. in the switch cabinet, for applications involving digital and analog image, data and voice transmission. Can be combined (also with fibre optic components) thanks to the modular structure. Tool-free turn latches enable simple closing and opening of the housing.

Dimensions and specifications may be changed without prior notice.



### Type

### Fibre Optic DIN RAIL splicebox vertical, telescope partially configured with couplings MM

### Cage

Housing material:  
Cover lock:  
Colour:

Steel sheet  
Fastening by means of screws  
Grey

### Equipment

Partially-configured  
Couplers

### Dimensions

Number of height modules (HM):  
Width:

3  
133 mm

### Preferred types

Part no.	Number of couplers	Type of coupler	Unit
<b>804303</b>	2	SC duplex	1
<b>804305</b>	4	ST	1
<b>804307</b>	2	LCdx	1

Dimensions and specifications may be changed without prior notice.

### Options

On request, different assembly variations, such as F-SMA, FC/PC, and DIN and/or diagonal cross section designs, are also available.

### Application

The Fibre Optic DIN rails are used for installing preassembled Breakout cables with cable splitter WKOM-03. The compact and robust construction and handsome design make them suitable for applications in the industry. The panels consist of a metal housing with integrated coupling heads are built in at the front. Breakout cables are inserted up and down. Modern components provide for excellent attenuation and low reflection losses.

# Machine outlet IP67

INDUSTRIAL ETHERNET



SC MM, IP67



## Type

**Industrial Ethernet, SCdx multimode outlets IP67**

## Configuration

Housing material:  
Colour:  
Outlet direction:  
Type of fastening:  
Dust protection:  
Protection classification (IP):

Aluminium die-cast  
Grey  
Straight  
Screw  
Hinged cover  
67

## Equipment

Type:  
Number of couplings:  
Suitable for fibre type:

Coupler  
SC  
2  
Multi-mode

## Dimension

175 x 110 x 45mm

## Area of application

Industrial environment

## Part no.

**801354**

Dimensions and specifications may be changed without prior notice.

## Packing unit

**5**

## Norms and standards

HELUCOM CONNECTING SYSTEMS® INDUSTRY component suitable for multimode fibre applications (G50/125µm and G62.5/125µm). Moreover it satisfies the MICE specifications (class 3), EMC requirements in accordance with DIN EN 6100, and the requirements of the IP 67 housing protection class.

## Application

Robust data connection socket (shielded) for the extreme implementation. Robust aluminum die-cast housing; meets all mechanical requirements like vibration, shock, and transverse forces. The socket is used either on the machine distributor (MD) or wall mounted directly on the machine (MC) as connection unit.

# Machine outlet IP65

INDUSTRIAL ETHERNET



SC MM, IP65



## Type

**Industrial Ethernet outlet plastic IP 65, SCdx POF/HCS/MM**

## Configuration

Housing material:  
Colour:  
Outlet direction:  
Type of fastening:  
Dust protection:  
Protection classification (IP):

Aluminium die-cast  
Grey similar to RAL 7032  
Straight  
Screw  
Hinged cover  
65

## Equipment

Type:  
Number of couplings:  
Suitable for fibre type:

Coupler  
SC  
2  
POF/HCS/MM

## Dimension

125 x 80 x 57mm

## Area of application

Industrial environment

## Part no.

**801421**

Dimensions and specifications may be changed without prior notice.

## Packing unit

**5**

## Norms and standards

HELUCOM CONNECTING SYSTEMS® INDUSTRY component suitable for POF, HCS and multimode fibre applications (980/1000µm, 200/230µm, 50/125µm and 62.5/125µm). More they satisfy the MICE specifications, EMC requirements in accordance with DIN EN 61000, and the IP65 housing protection class requirements. The socket can be used in a temperature range of 0°C to +70°C.

## Application

Robust data connection socket (shielded) for extreme implementation. Robust plastic housing, and satisfies all mechanical requirements like vibration, shock, and transverse forces. The socket is used either on the machine distributor (MD) or wall mounted directly on the machine (MC) as connection unit.

# Machine outlet top-hat rail

INDUSTRIAL ETHERNET



ST, SC, LCdx



## Type

### Configuration

Housing material:  
Colour:

Outlet direction:  
Type of fastening:  
Dust protection:

### Equipment

Type:  
Number of couplings:  
Suitable for fibre type:

### Dimension

### Area of application

### Part no.

### Packing unit

### Norms and standards

### Application

## Fibre optic top-hat rail installation data outlets

Plastic Pure White similar to RAL 9010 Angled Snap-in Hinged cover	Plastic Pure White similar to RAL 9010 Angled Snap-in Hinged cover	Plastic Pure White similar to RAL 9010 Angled Snap-in Hinged cover
---	---	---

Coupler ST 2 Multi-mode	Coupler LC 4 Multi-mode	Coupler SC 2 Multi-mode
----------------------------------	----------------------------------	----------------------------------

80 x 80 x 46mm	80 x 80 x 46mm	80 x 80 x 46mm
----------------	----------------	----------------

Industrial environment	Industrial environment	Industrial environment
------------------------	------------------------	------------------------

<b>801355</b>	<b>801357</b>	<b>801356</b>
---------------	---------------	---------------

Dimensions and specifications may be changed without prior notice.

<b>10</b>	<b>10</b>	<b>10</b>
-----------	-----------	-----------

HELUCOM CONNECTING SYSTEM INDUSTRY® system component suitable for multimode fibre applications (G50/125µm and G62.5/125µm).

As connection unit for DIN rail installation e.g. in the switch cabinet, for applications involving digital and analog image, data and voice transmission.

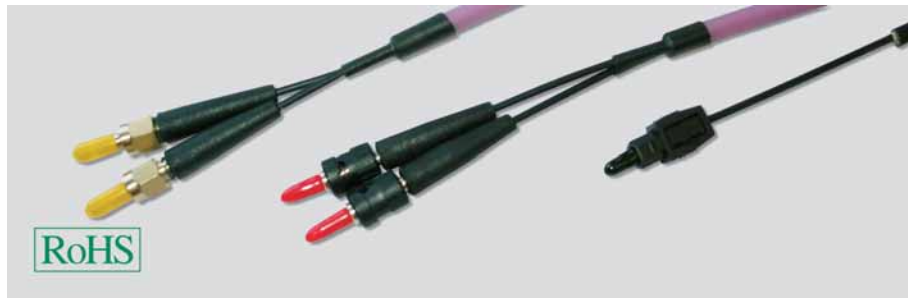

## Type

## Version

## Preferred types

### Jumper cable I-V2Y 1P 980/ 1000µm (POF)

Simplex

Part no.	End 1	End 2	Fibre type	Length	Unit
<b>801411</b>	ST	ST	POF 980/1000	2	10
<b>801413</b>	HFBR 4533 blau, simplex	HFBR 4533 blau, simplex	POF 980/1000	2	10
<b>801410</b>	F-SMA	F-SMA	POF 980/1000	2	10
<b>801472</b>	HFBR 4511 blue, simplex	HFBR 4511 blue, simplex	POF 980/1000	2	10
<b>801473</b>	HFBR 4503 grey, simplex	HFBR 4503 grey, simplex	POF 980/1000	2	10
<b>801474</b>	HFBR 4513 blue, simplex	HFBR 4513 blue, simplex	POF 980/1000	2	10
<b>801412</b>	HFBR 4531 black, simplex	HFBR 4531 black, simplex	POF 980/1000	2	10
<b>801471</b>	HFBR 4531 black, simplex	HFBR 4531 black, simplex	POF 980/1000	2	10
<b>801475</b>	F05 simplex	F05 simplex	POF 980/1000	2	10

Dimensions and specifications may be changed without prior notice.

## Options

These connecting cables are also available in other lengths and with other plug types, on request. We also supply jumper cable with PUR sheath reinforcement for implementation in extreme industrial environments.

## Application

POF (Polymer Optical Fibre) connection cable from HELUCOM® are particularly used in applications involving machine tools and industrial equipment, e.g. for connecting controller and drive. Systems such as SERCOS rely on POF fibre. POF jumper cables are characterized by a significantly more robust structure compared to traditional glass fibre lines. The version with PE coating is designed for normal implementation.





## Type

## Version

## Preferred types

### Jumper cable I-V(ZN)HH 2K 200/230µm (HCS)

Duplex

Part no.	End 1	End 2	Fibre type	Length m	Unit
<b>801415</b>	ST	ST	HCS 200/230	2	10
<b>801416</b>	HFBR 4521 simplex	HFBR 4521 simplex	HCS 200/230	2	10
<b>801414</b>	F-SMA	F-SMA	HCS 200/230	2	10
<b>801476</b>	F07 duplex	F07 duplex	HCS 200/230	2	10

Dimensions and specifications may be changed without prior notice.

## Options

These connecting cables are also available in other lengths and with other plug types, on request. We also supply jumper cable with PUR or PE sheath reinforcement for implementation in extreme industrial environments.

## Application

HCS (Hard Clad Silica) connection cables from HELUCOM® are particularly used in applications involving machine tools and industrial equipment, e.g. for connecting controller and drive. Systems such as LIGHTBUS rely on HCS fibre. HCS jumper cables are characterized by a significantly more robust structure compared to traditional glass fibre lines. The version with FRNC sheathing is designed for normal mobile implementation.



## Type

### Preferred types

## Fibre Optic connector

Part no.	Type	Suitable for fibre type	Unit
<b>801378</b>	HFBR 4501 grey, simplex	POF 980/1000	50
<b>801379</b>	HFBR 4511 blue, simplex	POF 980/1000	50
<b>801380</b>	HFBR 4503 grey, simplex	POF 980/1000	50
<b>801381</b>	HFBR 4513 blue, simplex	POF 980/1000	50
<b>801382</b>	HFBR 4516 latch, duplex	POF 980/1000	50
<b>800713</b>	HFBR 4533 blue, simplex	POF 980/1000	50
<b>800714</b>	HFBR 4531 black, simplex	POF 980/1000	50
<b>801387</b>	HFBR 4506 grey, duplex	POF 980/1000	50
<b>801388</b>	HFBR 4516 latch, duplex	POF 980/1000	50
<b>801383</b>	F05 simplex, grind and polish	POF 980/1000	50
<b>801384</b>	F05 simplex, hotplate	POF 980/1000	50
<b>801386</b>	TOCP 255 duplex	POF 980/1000	50
<b>801385</b>	F07 duplex, hotplate	POF 980/1000	50
<b>801390</b>	ST	POF 980/1000	50
<b>801420</b>	SC duplex	POF 980/1000	50
<b>82821</b>	F-SMA 2,2mm	POF 980/1000	50
<b>801389</b>	F-SMA 6,0mm	POF 980/1000	50
<b>801832</b>	HFBR 4521 blue simplex, for 2,2mm	HCS 200/230	50
<b>801392</b>	HFBR 4521 black simplex, for 2,2mm	HCS 200/230	50
<b>801393</b>	F05 simplex, für 2,2mm	HCS 200/230	50
<b>801394</b>	F07 duplex, für 2,2mm	HCS 200/230	50
<b>801396</b>	ST	HCS 200/230	50
<b>801419</b>	SC duplex	HCS 200/230	50
<b>801395</b>	F-SMA 2,2mm	HCS 200/230	50
<b>801418</b>	SC duplex	Multi-mode	50

Dimensions and specifications may be changed without prior notice.

## Options

### Included in delivery

### Application

On request, we also supply other plug connector types.

Fibre-optic plug (partly with housing, crimping)

Fibre optic plugs and couplings serve as links or removable connections for equipment outputs or distribution centers. The types designed have been especially designed for industrial use (light-duty or heavy-duty). They can be assembled in the field and, depending on the type, they are available in a clamp, crimp, adhesive, or hot plate version. According to IAONA the ST or the F-SMA plug is specified as standard.



Server

Fan Unit data cabinet

Distribution cabinets



# ■ NETWORK SYSTEM CABINETS

<b>Designation</b>	<b>Page</b>
Network cabinet 19"	<b>332</b>
Features - Distribution cabinet	<b>333</b>
Construction - Distribution cabinet	<b>334</b>
Wall distribution box	<b>335</b>
Features - Wall distribution box	<b>336</b>
19" connector strips HELU Line	<b>337</b>
Rack socket	<b>338</b>
General accessories	<b>339</b>
Shelf	<b>340</b>
Fan Unit data cabinet	<b>341</b>
Fastening set	<b>342</b>
Illumination of distribution boxes	<b>343</b>

# Network Distribution Rack

## Network Cabinet

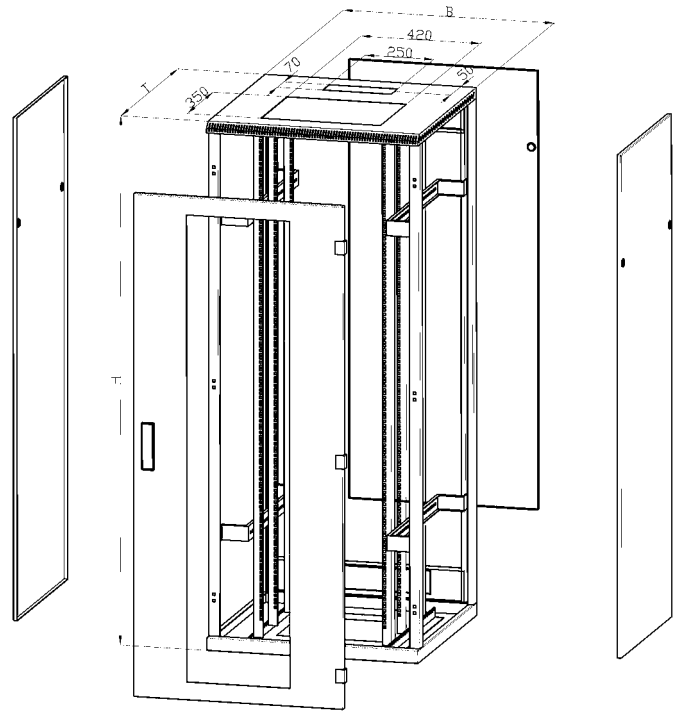

### Details

- sheet steel case pre -assembled, self ventilated
- Light gray RAL 7035
- Cable feeding possible from the ground or top
- Earthing set pre -installed
- Protection class IP20
- Accessories: 1x strip, 1x cage nut set (20 pieces), 4 levelling feet M10, 2x keys

### Heat dissipation

- Energy dissipation via cabinet surface up to 450 W (at a temperature differential of 15°C)

### Preferred types

Width mm	Height mm	Depth mm	Number of height modules (HM)	Design	Unit	Part no.
800	1980	800	42	Steel door, rear, Glass door, front	1	<b>801425</b>
600	1980	600	42	Steel door, rear, Glass door, front	1	<b>804051</b>
600	1980	800	42	Steel door, rear, Glass door, front	1	<b>803480</b>

Dimensions and specifications may be changed without prior notice.

# ■ FEATURES

## Vario distributor cabinet

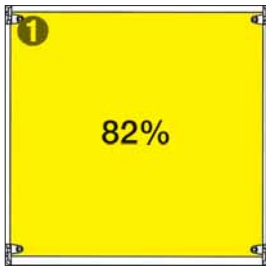

**01** Space-saving construction makes it possible to utilise 82% of the area occupied by the product for installation of component parts and/ or cable.



**06** If desired, doors and side compartments can be equipped with locks to prevent unauthorised access.



**02** Cable in/ out using tailor-made cover plates / panels that can be removed on all sides at the base.



**07** After disengaging the quick-release connectors, it is possible to remove side and rear parts in only seconds to permit rapid installation of components.



**03** Use of the Miracel multi-function brace makes it much easier to save space and maintain order when installing cables. Even cabinets with a width of 600 mm are designed with lateral compartment space for continuous cable or ventilation installation.



**08** Decorative profiles on the door / cabinet allow you to choose the colours that suit you best.

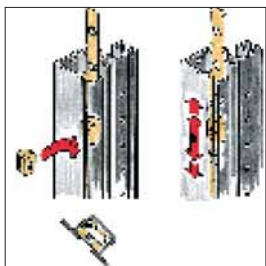

**04** Raster rails utilising the proven T-slot and spring-nut construction make it easy to install component parts with continuous adjustment or with a 19" or 25-mm raster.



**09** A wide adjustable base foot reduces floor load and makes it possible to compensate for uneven surfaces.



**05** Front and rear doors open at an angle of 180 degrees, increasing the accessibility of components for installation and repair, especially on cabinets arranged in rows.

# ■ CONSTRUCTION

Vario distributor cabinet

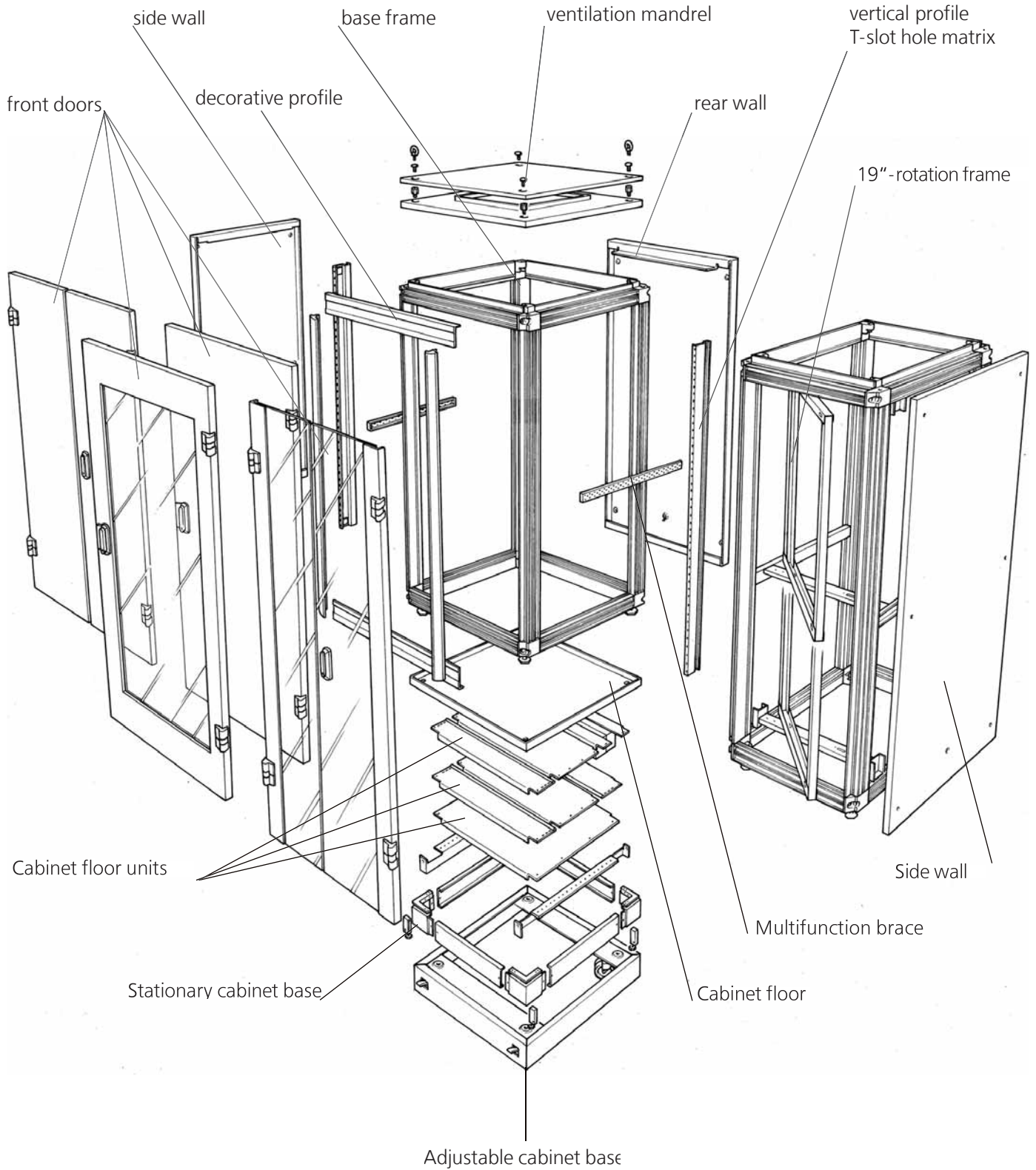



# Network Distribution Rack

## Wall mounting Rack



### Details:

- Steel sheet housing
- preassembled, self ventilated
- Door with security glass
- Cabling from top or bottom
- Protection class IP20
- Wall fastening
- Color:light grey RAL7035
- housing totally grounded
- Accessories inclusive: 2xkeys, 1x set cage nut and screws , 1x cable strip

### Preferred types

Width mm	Height mm	Depth mm	Number of height modules (HM)	Design	Unit	Part no.
600	330	500	6	Glass door, front	1	<b>801687</b>
600	330	400	6	Glass door, front	1	<b>804055</b>
600	465	400	9	Glass door, front	1	<b>804056</b>
600	465	500	9	Glass door, front	1	<b>801688</b>
600	600	500	12	Glass door, front	1	<b>801689</b>
600	600	400	12	Glass door, front	1	<b>804057</b>
600	730	500	15	Glass door, front	1	<b>801690</b>
600	730	400	15	Glass door, front	1	<b>804058</b>
600	860	500	18	Glass door, front	1	<b>801691</b>
600	860	400	18	Glass door, front	1	<b>804059</b>

Dimensions and specifications may be changed without prior notice.

# ■ FEATURES

## Wall housing



**01** Up to 50% of the transport volume is reduced using „flat-pack“ packaging. Spacesaving packaging facilitates transport until installation.



**04** Large switch area on side and cable clamping rails (available as accessories) enable well ordered cable installation.



**02** Easy installation thanks to: Pre-fabricated keyholes on the back side Quick-insert support rails and cover pieces Symmetrical housing construction



**05** 19" or metric installation possible, Sliding bolt construction makes it easy to replace door stops. Ventilation design can be expanded at a later date using the optional active ventilation unit.



**03** Accessibility from all sides makes installation of component parts easier. Open-plan construction facilitates on-site connection of already existent cable strands.



**06** Pre-drilled holes on the vertical profile and back side make it easy to attach accessories such as socket strips.

# Network Distribution Rack

## Socket Strips

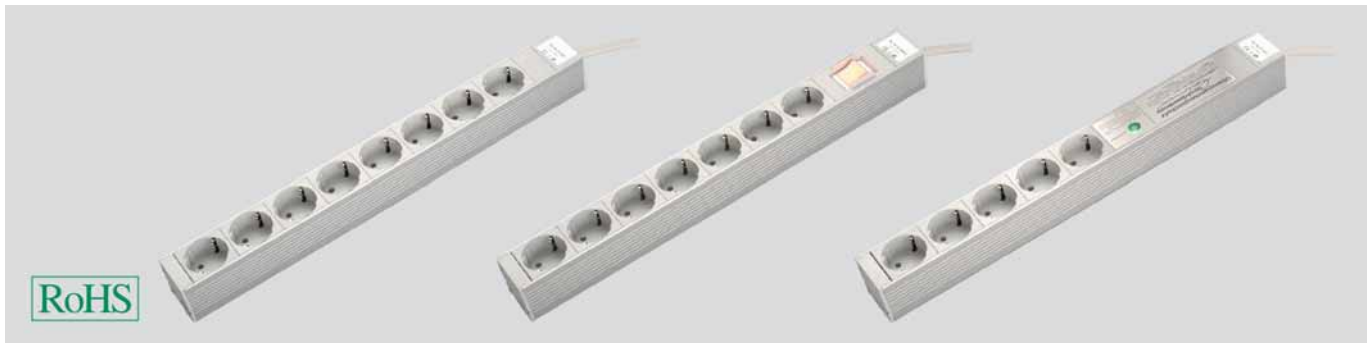

### Characteristics

Housing made of sturdy aluminium U housing, socket inserts made of PA, modular design and rotated 45°. Mounting angle rotatable in 900 steps. Inlet HO5VV-F 3G1.5 mm<sup>2</sup> (250 V/16 A), length: 2.0m: Manufactured according to DIN VDE 0620/05.92-DIN 49440 (sockets), E DIN VDE 0675 part 6 (overvoltage protection) and EN 133200:1994 (filter). Color of the plastic components grey similar to RAL 7035.

### Preferred types

#### Series HELU Line

Socket type	Part no.	Unit
HELU Line 19" 8x without switch	<b>82904</b>	1
HELU Line 19" 7x with switch	<b>82905</b>	1
HELU Line 19" 5x without switch, thermistor-type equipment protection	<b>82906</b>	1
HELU Line 19" 5x residual-current personnel protection system, 2-pin, 30 mA/30mS	<b>82908</b>	1
HELU Line 19" 5x circuit-breaker, 2-pin, 16A/B	<b>82909</b>	1

Dimensions and specifications may be changed without prior notice.

# Network Distribution Rack

Socket DV



## Characteristics

Socket for network cabinets inclusive mounting screws  
M6x8mm  
Material: Steel plate  
Paint Finish: RAL 7035, light grey  
Enlargement for network rack to install cables from socket easier

## Preferred types

Description	Suitable for ventilation/venting	Material	Height mm	For cabinet width mm	For cabinet depth mm	Part no.	Unit
Rack Socket	yes	Steel plate, light grey, Ral 7035	100	600	600	<b>801876</b>	1
Rack Socket	yes	Steel plate, light grey, Ral 7035	100	600	800	<b>801881</b>	1
Rack Socket	yes	Steel plate, light grey, Ral 7035	100	800	800	<b>801674</b>	1

Dimensions and specifications may be changed without prior notice.

# Network Distribution Rack

## Accessories



### Characteristics

#### **19-inch hole matrix**

Elements to reinforce or to enlarge the network rack. Help to mount active components or heavy duty lower shelf in existing cabinets. 19-inch hole matrix included. Rack mount nuts mounting possible.

### Preferred types

#### **19" profiles**

Description	Material	Surface	Number of height modules (HM)	Suitable for	Part no.	Unit
19-inch hole matrix	Stainless steel	Galvanised	12	Wall box	<b>82052</b>	1
19-inch hole matrix	Stainless steel	Galvanised	15	Floor box	<b>82097</b>	1
19-inch hole matrix	Stainless steel	Galvanised	21	Floor box	<b>82040</b>	1
19-inch hole matrix	Stainless steel	Galvanised	41	Floor cabinet	<b>82047</b>	1

Dimensions and specifications may be changed without prior notice.

# Network Distribution Rack

## Accessoires



### Characteristics

Shelf, adjustable  
For installation in all networking and server cabinets and rack frames, mouting with screws and cage nut  
Material: steel sheet  
Finish: RAL7035, light grey

### Preferred types

#### Shelf

Description	Width mm	Depth mm	Extractable	Load rating N	Suitable for	Part no.	Unit
Shelf 1U	432	380	no	100	Floor cabinet	<b>801754</b>	1
Pullout shelf 1U	432	380	yes	150	Floor cabinet	<b>801697</b>	1
Pullout shelf 1U	440	350	yes	10	Floor cabinet	<b>801849</b>	1
Pullout shelf 1U	440	500	yes	50	Floor cabinet	<b>801878</b>	1
Pullout shelf 1U	440	500	yes	50	Floor cabinet	<b>801805</b>	1
Shelf 2U	432	380	no	20	Floor cabinet	<b>82043</b>	1
Pullout shelf 2U	445	300	no	15	Floor cabinet	<b>801701</b>	1
Shelf 2U	445	400	no	25	Floor cabinet	<b>802716</b>	1

Dimensions and specifications may be changed without prior notice.

# Network Distribution Rack

## Fan units



### Characteristics

#### Fan unit

Roof fan, 1U, Weight 3.9 kg  
 Fan, capacity 160 cbm/h  
 For installation in all networking and server cab.  
 Control via connected thermostat  
 Thermostat and mounting material included  
 Rear sided mains connection via non-heating appliance socket (connection cable not included)  
 Rated voltage 230 V, 50 Hz  
 Illuminated switch ON/OFF  
 Material: steel sheet  
 Finish: RAL7035, light grey  
 Fan features:  
 Rated voltage 230 V, Frequency 50 Hz, Rated power 22 W, Speed 2700 r/min, Noise level 44 dB(A), Air capacity 160 m<sup>3</sup>/h, Temperature range -10 to +70 °C, Dimensions 119 x 199 x 38 mm

#### Other Accessories

Mounting equipment and other passiv elements for data racks for orderly and clearly cable routing please find on page number 89.

### Preferred types

#### Fan units

Description	Number of fans	With thermostat	Installation location	Suitable for	Part no.	Unit
Fan Unit data cabinet, 2-fan	2	yes	top area	Floor box	<b>82055</b>	1
Fan plate, 4-fan	4	yes	top area	Floor cabinet	<b>82039</b>	1

Dimensions and specifications may be changed without prior notice.

# Network Distribution Rack

## Mounting materials



### Preferred types

### Mounting materials

Description	Number of elements which can be installed	For fastening of	Suitable for	Part no.	Unit
Set of captive nuts	20	19-inch components	Floor cabinet	<b>82058</b>	1
Cable Routing Bracket	20	19-inch components	Floor cabinet	<b>801699</b>	1
Fastening set screen-profile	50	Louvered profile	Wall box	<b>82053</b>	1
Cable routing panel 19"	42	Cables	Floor cabinet	<b>802764</b>	1
Cable tidy rail 19"	2	Cables	Floor cabinet	<b>804244</b>	1

Dimensions and specifications may be changed without prior notice.



# Network Distribution Rack

## Lighting



### Preferred types

### Lighting

Description	Material	Length mm	Suitable for	Part no.	Unit
Cabinet light, Luminestra	Plastic	365	Floor cabinet	<b>800455</b>	1
Cabinet light, compact	Plastic	365	Universal	<b>80305</b>	1

Dimensions and specifications may be changed without prior notice.

Measuring instrument toolbox

HELUCUT

ASSEMBLY CASE

Crimping tool



## ■ MEASUREMENT & PROCESSING TECHNICS

<b>Designation</b>	<b>Page</b>
OTDR OV 1000 QUAD MDSD-SC	346
DTX Compact-OTDR QUAD Kit	347
Measuring instrument toolbox POF /TOCP 255/F07	348
Measuring instrument toolbox HCS , FSMA	349
Fibre-optic toolbox	350
Cut start tools fibre-optic, HELUCUT I 0,9-4,2	351
Cut start tools fibre-optic, HELUCUT II 4,2-10,5	351
POF plug manufacture toolbox ST	352
POF plug manufacture toolbox F-SMA	352
Tools for POF processing I HELUCUT'n STRIPP	353
Tools for POF processing I HELUCUT'n STRIPP Multi	353
Tools for POF processing II Multi Stripper Tool	354
Tools for POF processing HELUcrimp	354
HCS plug manufacture toolbox ST	355
HCS plug manufacture toolbox F-SMA	355
Test device for PROFIBUS systems	356
RJ45 crimping tool HELUCRIMP45	357
Crimping tool for Harting Industrial RJ45 8 - poles	357
Stripper for Bus cables, SKABI I	358
Stripper for LAN cables HELU-LAN 12	358
Stripper for PROFINet™ cables, SKABI II	359



## Characteristics

Roof fan, 1U, Weight 7 kg  
4 Fans, capacity 640 cbm/h  
For installation in all networking and server cab.  
Control via connected thermostat  
Thermostat and mounting material included  
Rear sided mains connection via non-heating appliance socket (connection cable not included)  
Rated voltage 230 V, 50 Hz  
Illuminated switch ON/OFF  
Material: steel sheet  
Finish: RAL7035, light grey  
Fan features:  
Rated voltage 230 V, Frequency 50 Hz, Rated power 22 W, Speed 2700 r/min, Noise level 44 dB(A), Air capacity 160 m<sup>3</sup>/h, Temperature range -10 to +70 °C, Dimensions 119 x 199 x 38 mm

## Application

- Test and collect data up to four wavelengths by pressing only one button
- Very fast acquisition time
- Fast ready-to-measure boot-up time of 4 seconds

## Details

- Simultaneous use of touch screen, short-cut keys and tracking knob for high user convenience
- Maximum 256,000 data points for highest resolution
- Loss resolution of 0.001 dB
- 6.4" full VGA touch screen
- Three test modes (auto, advanced and template) fit best to user skills and applications for maximum measurement convenience
- Possible configurations cover all typical fiber applications from long-haul and WDM to metro networks, FTTx as well as LAN
- Easy-to-use post-processing software OSTView with professional report generation function including bidirectional analysis and quick print function
- Powerful Li-Ion battery provide mains independent operation time of 8 hours (Bellcore TR-NWT-001138)
- Diverse storage options (in addition to 80 MB builtin flash memory, two USB ports<sup>2</sup>) and a CF card slot
- Internal memory sufficient for up to 1,500 typical traces
- Numerous connection ports for easy connectivity for convenient download and upgrade
- 10/100 Mb/s Ethernet RJ-45 network interface
- Rugged and waterproof housing for long life time

## Designation

OTDR OV 1000 QUAD MDSD-SC

## Part no.

**802495**

Dimensions and specifications may be changed without prior notice.



## Characteristics

The DTX Compact OTDR is a revolutionary enhancement to the DTX CableAnalyzer. The DTX Compact OTDR is a full featured Optical Time Domain Reflectometer (OTDR) module that snaps onto a DTX CableAnalyzer. In addition to copper testing, it makes this powerful certification tool a complete, easy-to-use OTDR that shoots and analyzes traces on singlemode and multimode fiber. With the DTX Compact OTDR, the DTX CableAnalyzer becomes the only cable tester that can completely certify copper and fiber cabling according to all industry standards. The DTX Compact OTDR makes every technician a fiber expert with unparalleled ease of use, automatic OTDR settings, loss limits for events and fiber links, launch fiber compensation, automatic event analysis, and results management, all with the familiar user interface of the DTX CableAnalyzer.

## Application

- Acceptance and test measurements of all common single- and multi-mode fibre optics (1310/1550nm and 850/1300nm)
- With its compact design, the DTX Compact-OTDR is outstanding for field applications

## Details

- Expanding installation revenue without expanding staff
- Shortening technicians learning curve for fiber testing
- Performing Basic (Tier 1) and Extended (Tier 2) fiber certification with a single tool
- Accelerating troubleshooting with a powerful, single-ended OTDR for fiber and extensive DTX diagnostics for copper
- Delivering integrated copper and fiber reports using LinkWare™ Results Management Software

## Designation

DTX Compact OTDR QUAD

## Part no.

**802496**

Dimensions and specifications may be changed without prior notice.



## Characteristics

The output of the signal generator is a modulatable power source, which creates a stabilized optical power output by means of an LED adapter. With the micro process technology used, the measuring instrument permits the measurement of two wavelengths as well as the display of the absolute power in 5W or dBm. For relative power measurements, the measured value is displayed in dB. A change adapter system permits connecting all common fibre-optic cable plug connectors. Systems like TCOP 155, F-SMA, ST, HFBR, F05/ F07 or SC are available.

## Application

The good characteristics and the precise coupling to ready-made fibre-optic cables with the exchangeable adapter system allow using the signal generators and receiver in a variety of applications, such as installation control, quality control, attenuation measurements of fibre-optic cables, laboratory tests, or testing visual transmitters and receivers.

## Details

Measuring instrument OPM1:

- Optical power measuring instrument
- 660nm and 850nm calibrated wavelengths
- M12 change adapter connector
- 25mm x 50mm LC display
- Plastic housing
- sturdy plastic sleeve
- simple operation

Signal generator MS100HU:

- Stabilized power source
- 1, 10, 20 kHz modulating frequency
- BNC female connector
- 9V battery operation or ext. power pack
- 25mm x 50mm LC display
- Plastic housing
- sturdy plastic sleeve
- simple operation

## Designation

Measuring instrument case POF/ TOCP 255/F07

## Part no.

**800597**

Dimensions and specifications may be changed without prior notice.



## Characteristics

The output of the signal generator is a modulatable power source, which creates a stabilized optical power output by means of an LED adapter.

With the micro process technology used, the measuring instrument permits the measurement of two wavelengths as well as the display of the absolute power in 5W or dBm. For relative power measurements, the measured value is displayed in dB. A change adapter system permits connecting all common fibre-optic cable plug connectors. Following systems are available:

SC Adapter  
FST Adapter  
HFBR Adapter  
TOPCP Adapter

## Application

The good characteristics and the precise coupling to ready-made fibre-optic cables with the exchangeable adapter system allow using the signal generators and receiver in a variety of applications, such as installation control, quality control, attenuation measurements of fibre-optic cables, laboratory tests, or testing visual transmitters and receivers.

## Details

Measuring instrument OPM1:

- Optical power measuring instrument
- 660nm and 850nm calibrated wavelengths
- M12 change adapter connector
- 25mm x 50mm LC display
- Plastic housing
- sturdy plastic sleeve
- simple operation

Signal generator MS100HU:

- Stabilized power source
- 1, 10, 20 kHz modulating frequency
- BNC female connector
- 9V battery operation or ext. power pack
- 25mm x 50mm LC display
- Plastic housing
- sturdy plastic sleeve
- simple operation

## Designation

Measuring instrument toolbox HCS

## Part no.

**801465**

Dimensions and specifications may be changed without prior notice.



## Application

When assembling fibre-optic cables and cores, special tools are required. The high-quality tools are put together in the fibre-optic toolbox.

## Details

Generally, the toolbox is equipped with two removable, double-sided tool plates, a covering tool plate, and a document compartment. The essential components are a hot air blower, cross head screw drivers, Miller stand-off pliers, Claus stand-off, tube socket wrench, bolt cutter as well as consumption materials.

## Designation

Fibre-optic tool case

## Part no.

**800378**

Dimensions and specifications may be changed without prior notice.

## Equipment of fibre optical tool case







## Application

Tool for damage-free stripping of fibre optics, cut or uncut mini grooved cable. Also for suitable for rough grooved cables as well as inside of stranding.

## Details

- Multifibre buffer tube diameters to 1.8mm to 4.2mm can be cut by means of replaceable multifibre buffer tube guides
- Tool made of burnished special tool steel with plastic handle
- Simple time and cost-saving operation

## Included in delivery

Cut start tool, core guide set, spatula, hexagon key, and spare knife, supplied in a plastic case

## Designation

HELUCUT I 0.9-4.2

## Part no.

**800380**

Dimensions and specifications may be changed without prior notice.



## Application

Tool for damage-free stripping of fibre optics, cut or uncut maxi grooved cable. This avoids fibre separation when creating of branches.

## Details

- The application area is grooved cables with a diameter of 4.0 - 10,0 mm (expandable to 14.0mm)
- Interchangeable grooved cable guide (5.0/6.0/7.0/8.0/9.0/10.0)
- Diametric cutting technique (with cable supply)
- High continuous cutting performance
- Simple time and cost-saving operation

## Included in delivery

Cut start tool, cutting set, cable shears, toggle and hexagon key, supplied in a plastic case

## Designation

HELUCUT II 4.2-10.5

## Part no.

**800381**

Dimensions and specifications may be changed without prior notice.



## Application

This box can be used for both, mobile applications on site and stationary applications.

**Type for ST (BFOC) connector**

## Details

The assembly toolbox contains all necessary processing tools for professional POF 980/1000µm plug assembly for ST plugs. Essential components are: Crimping pliers 4-notch, positioning sleeve, crimping pliers 5-edge, sheath stripping tool, fibre stripper, Kevlar scissors, cutter, buffing wheels, polishing paper (grain 1000) and aluminum case.

## Options

Naturally, we can also supply toolboxes for processing HP and Toshiba plug systems.

## Designation

POF Connector Assembly Case ST

## Part no.

**801186**

Dimensions and specifications may be changed without prior notice.



## Application

This box can be used for both, mobile applications on site and stationary applications.

**Type for F-SMA connector**

## Details

The assembly toolbox contains all necessary processing tools for professional POF 980/1000µm plug assembly for F-SMA plugs. Essential components are: Crimping pliers 4-notch, positioning sleeve, crimping pliers 5-edge, sheath stripping tool, fibre stripper, Kevlar scissors, cutter, buffing wheels, polishing paper (grain 1000) and aluminum case.

## Options

Naturally, we can also supply toolboxes for processing HP and Toshiba plug systems.

## Designation

POF Connector Assembly Case F-SMA

## Part no.

**801400**

Dimensions and specifications may be changed without prior notice.



## Application

Tool for damage-free cutting and crimping of 2.2 mm synthetic fibres (POF). Repolishing is no longer necessary.

## Details

- The application area is POF fibres with 2.2 mm diameter
- Interchangeable cutting device
- Stripping length of 4.0 - 20.0 mm
- Tool made of burnished special tool steel with plastic handle
- Simple time and cost-saving operation

## Included in delivery

Pliers made from special tool steel with cutting device and stripping knife

## Designation

HELUCUT`n STRIPP

## Part no.

**800382**

Dimensions and specifications may be changed without prior notice.



## Application

Tool for damage-free cutting, stripping and crimping of 2.2 mm synthetic fibres (POF). Repolishing is no longer necessary.

## Details

- The application area is POF fibres with 2.2 mm diameter
- Adaptable to different contacts
- Optimal crimping quality due to safety interlock
- Tool made of burnished special tool steel with plastic handle
- Simple time and cost-saving operation

## Included in delivery

Pliers made from special tool steel with cutting device

## Designation

HELUCUT`n STRIPP Multi

## Part no.

**800383**

Dimensions and specifications may be changed without prior notice.



## Application

Tool for damage-free cutting and stripping of synthetic fibre lines (POF).

## Details

- Field of application are POF fibres with 2.2 mm in diameter and PUR-encased POF fibres (simplex, duplex, quattro), Make: HELUKABEL® art. no. 81611, 81882, 80629, 80630
- Interchangeable cutting device
- Stripping length of 4.0 - 20.0 mm
- Tool made of burnished special tool steel with plastic handle
- Simple time and cost-saving operation

## Included in delivery

Pliers made from special tool steel with cutting device and stripping knife set.

## Designation

POF MULTI STRIPPER TOOL

## Part no.

**81320**

Dimensions and specifications may be changed without prior notice.



## Application

Tool for trouble-free crimping of 2.2 mm synthetic fibres (POF).

## Details

- The application area is POF fibres with 2.2 mm diameter
- Suitable for different contacts (4.85mm diameter + 3.15mm key width)
- Optimal crimping quality due to safety interlock
- Unblocking possibilities in case of possible faulty operation
- Tool made from durable special tool steel with plastic handle
- Very simple operation

## Included in delivery

Tool made from special tool steel

## Designation

HELUcrimp

## Part no.

**800385**

Dimensions and specifications may be changed without prior notice.



## Application

This box can be used for both, mobile applications on site and stationary applications.

## Details

The assembly toolbox contains all necessary processing tools for professional HCS 200/230 $\mu$ m plug assembly "adhesive technique" for ST plugs. Essential components are: Crimping pliers, 3 x fibre strippers (0,6, 0,3, 0,18mm), scoring pin, hardening oven, manual microscope (100x), change adapter ST, polishing paper (grain 0.3 $\mu$ m, 5 $\mu$ m), polishing plate, cutter, polishing disk, epoxy adhesive, syringe and aluminum case.

## Options

Naturally, we can also supply toolboxes for processing HP and Toshiba plug systems.

## Designation

HCS Connector Assembly Case for ST

## Part no.

**801403**

Dimensions and specifications may be changed without prior notice.



## Application

This box can be used for both, mobile applications on site and stationary applications.

## Details

The assembly toolbox contains all necessary processing tools for professional HCS 200/230 $\mu$ m plug assembly "adhesive technique" for F-SMA plugs. Essential components are: Crimping pliers, 3 x fibre strippers (0,6, 0,3, 0,18mm), scoring pin, hardening oven, manual microscope (100x), change adapter ST, polishing paper (grain 0.3 $\mu$ m, 5 $\mu$ m), polishing plate, cutter, polishing disk, epoxy adhesive, syringe and aluminum case.

## Options

Naturally, we can also supply toolboxes for processing HP and Toshiba plug systems.

## Designation

HCS CONNECTOR ASSEMBLY CASE FOR F-SMA PLUG

## Part no.

**801404**

Dimensions and specifications may be changed without prior notice.



## Application

The test equipment is suitable for the error analysis of PROFIBUS DP segments. With its possibility to test these segments systematically without large effort, time-consuming individual tests are unnecessary.

## Details

- Connector PROFESSIONAL BUS RS485 (DB9 socket strip) and RS232 (DB9 socket strip)
- Power supply with rechargeable battery pack 4.8V/1.500 mAh NIMH
- Error detection in 3 steps: without closure, with one closure and with two closure
- Short-circuit display A-B core with distance reading in meters
- Short-circuit display A-B shield with distance reading in meters
- Line and shield break display with distance reading in meters
- Display for interchanged signal lines A-B
- Display for incorrect or missing bus closures
- Display for incorrect position of the bus connectors
- Error due to inadmissible line length
- Error in characteristic impedance
- Incorrectly used cable type
- Reflections
- Error in sending and reception levels
- Error due to use of inadmissible branch lines

## Included in delivery

Basic equipment in the sturdy service toolbox: 2 rechargeable batteries, international charging station, RS232 cable, PROFIBUS branch line, PROFIBUS T line, bus cutter, gender changer (3), documentation

## Designation

Measuring instrument for PROFIBUS NetTEST II

## Part no.

**800657**

Dimensions and specifications may be changed without prior notice.





## Application

Pliers for crimping of shielded modular RJ45 plug connectors.

## Details

- Crimping pliers for shielded RJ45 TYPE Hirose TM11, TM21, TM31
- Crimps the strain relief in the same work step
- particularly suited for manufacturing "on site"

## Included in delivery

RJ45 pliers

## Designation

HELUCRIMP45

## Part no.

**82493**

Dimensions and specifications may be changed without prior notice.



## Application

Tool for crimping Harting Industrial IP20 RJ45 8 - poles (HELUKABEL® type 802258 and 802259).

## Details

- Straight action principle with ratchet release
- Contact positioning with locator
- Ergonomic soft grips

## Included in delivery

Crimping tool made of special steel.

## Designation

Crimping tool for Harting Industrial RJ45 8 - poles

## Part no.

**802375**

Dimensions and specifications may be changed without prior notice.



## Application

Dismantling and stripping the special Profibus SK types.

## Details

- Triple-stage stand-off of sheath, screen, and filler
- Knife block can be inserted on both sides
- Standard port for SK bus lines with outside diameter of 8.0 mm
- Variable tool use thanks to adjustable screw holders or replacement of the knife block for other line types as well, e.g. coaxial cables

## Included in delivery

Stripping tools with brown knife block and adjustment block. As an option, other knife blocks for other diameters are available.

## Options

Knife cartridges for other cable types or constructions

## Designation

Stripper for SK bus cables

## Part no.

**81233**

Dimensions and specifications may be changed without prior notice.



## Application

Dismantling tool for unshielded and shielded data cables.

## Details

- Can cut UTP and STP data cables and other cables of up to 4 mm<sup>2</sup>
- Dismantling of the outer insulation of UTP and STP data cables, as well as other round cables from 0.5 - 12.5 mm
- No damage to shielding or conductor due to stripping knife adjustable to different insulation thicknesses
- Length stop for repeatable cutting and stripping lengths

## Included in delivery

Dismantling tool with length stop

## Designation

HELU-LAN 12

## Part no.

**82902**

Dimensions and specifications may be changed without prior notice.





## Application

Dismantling and stripping the special PROFInet™ types A, B, C.

## Details

- Triple-stage stand-off of sheath, screen, and filler
- Knife block can be inserted on both sides
- Standard port for PROFInet™ lines with outside diameter of 6.5 mm
- Variable tool use thanks to adjustable screw holders or replacement of the knife block for other line types as well, e.g. coaxial cables

## Included in delivery

Stripping tools with green knife block and adjustment block. As an option, other knife blocks for other diameters are available.

## Options

Knife cartridges for other cable types or constructions

## Designation

Stripper for PROFInet cables

## Part no.

**801497**

Dimensions and specifications may be changed without prior notice.

# Switche

## Converter



## ■ ACTIVE COMPONENTS

<b>Designation</b>	<b>Page</b>
Active Components – Switches for top DIN Rails	<b>362</b>
Active Components – Power supply for DIN Rails	<b>363</b>

# Active Components

## Switches for top DIN Rails



## Switches for top DIN Rails

### Description

Entry level Industrial ETHERNET rail switch with store and forward switching mode and speeds of 10/100 and 1000Mbit/s. All devices are maintenance-free and automatically adapt to your requirements. Switch with copper RJ45 and fibre optic port. Ideal for using as media converters. Plug and play.

All devices have the following features:

- Autocrossing (crossover adaption, straight or crossed)
- Autonegotiation (speed adaption 10/100/1000)
- Autopolarity (pin correction on RJ 45 connector)
- Redundant power supply (2x DC In: 9.6 V to 32 V)
- Proliferation of options for all applications (e.g. ship building, vehicle construction, automation)

Compact design and low weight

### Technical Data

- Voltage: 9,6 V DC-32 V DC
- Max. power consumption: 130 mA
- Humidity: 10-95%
- Protection class: IP30
- cUL 508
- Accessories: Exclusive 19" mounting frame 802793 and power unit (e.g. RPS15 Part No. 803178) available to order.

Type	Description	Operating temperature	Speed	Ports	Part No.
Spider 1Tx/1Fx	1x TP RJ45, 1x Fx SC duplex	0°C bis +60°C	10/100 Mbit/s	2	802851
Spider 4Tx/1Fx	4x TP RJ45, 1x Fx SC duplex	0°C bis +60°C	10/100 Mbit/s	5	803177
Spider 5 Tx	5x TP RJ45	0°C bis +60°C	10/100 Mbit/s	5	803323
Spider 8TX	8x TP RJ45	0°C bis +60°C	10/100 Mbit/s	8	803324
Spider II Giga 5T/2S EEC	5x TP RJ45, 2x GE-SFP slots	-40°C bis +70°C	10/100/1000 Mbit/s	7	803326
Spider II Giga 5T EEC	5x TP RJ45	-40°C bis +70°C	10/100/1000 Mbit/s	5	803325

Other versions on request.

Dimensions and specifications may be changed without prior notice.

# Active Components

## Power supply for DIN Rails



### Description

For quick and safe installation just use our power supplies or the 19" mounting frame for data rack integration. 24 V DC power supply for the redundant power to DIN Rail components with one terminal block 3-pin 230 V (100 V - 240 V AC In) and one terminal block 5-pin, 2x24 V DC Out. Output current up to 5 A. With LED diagnostic: green Power and DC ON. Power units can be switched parallel!

### Technical Data

- Diagnostic: LED (Power, DC ON)
- Redundancy function: Power supply can be switched parallel
- Humidity (non-condensing): Max. 95%
- Weight: 130 - 500 g
- Protection class: IP 20
- EMC, interference immunity: EN 50082-1: EN 61000-6-2 (encompasses EN 55024)  
EN 50082-2: EN 61000-6-2 (encompasses EN 55024)
- EMC, emitted interference: EN 50081-1  
EN 50081-2
- Safety of industrial control equipment: cUL 508
- Safety of information technology equipment: cUL 60950 (E 137006)
- Hazardous locations cUL 1604 class 1 Div. 2
- Scope of delivery: Rail power supply, description and operating manual

Type	Description	Operating temperature	Out	In	Part No.
RPS 15	DIN Rail power pack	-10°C bis 70°C	24, 5 V DC/30W max. 1,3 A	100 V - 240 AC max. 0,6 A	803178
RPS 80 EEC	DIN Rail power pack	-25°C bis 70°C	24, 5 V DC/80W max. 3,3 A	100 V - 240 V AC max. 1,6 A	803331

Dimensions and specifications may be changed without prior notice.

Other versions on request.

## 19" mounting frame for top hat rail components

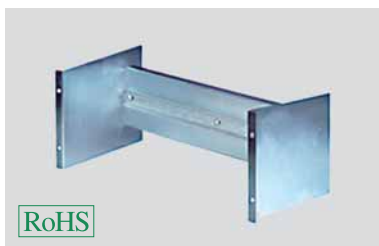

### Description

Frame for mounting DIN Rail components for fixed installation in data and network cabinets with 19" frames. Mounting to 19" rail using cage nuts.

Type	Description	Dimensions	Assembly	Weight	Part No.
DIN rail rdapter	Mounting frame for 19" cabinets	BxHxT 481 mm (435mm usable) x177mmx275mm	19" rack or switch cabinet	1 kg	802793



## ■ SERVICES

<b>Designation</b>	<b>Page</b>
Expert planning and project development	366
Working to meet all your business needs	366
Providing you with high-quality services you can rely on	367
Practical training	367

## ■ SERVICES

### Expert planning and project development

For each and every network, the right planning is crucial, regardless of whether you're considering installation of a new network, inter-networking between existing islands or expansion and optimisation of an already present network. When investing in a network, it is essential to choose your products carefully to ensure the quality and security of your investment well into the future.

Here, HELUKABEL® provides you with a proven and well-structured concept that maintains an optimum infrastructure during all stages of planning while focusing on finding the best possible technical solutions.

Taken into account are not only the company's development and its communication targets, but also the need to protect investments made for existing solutions.

Other important factors that must be considered when planning are the investment security and reliability of the network infrastructure of the future. The reliability and efficiency of a network in the future all depends on how well the network was initially planned. At HELUKABEL®, planning is carried out by experts in the field, so you can be sure that your investment is secure.

### Working to meet all your business needs

HELUKABEL® offers a wide array of network solutions to meet your every need. Regardless of your network structure or technology, we can provide you with a turnkey system that meets your individual requirements – from delivery of the cable and on-site installation all the way to final transfer of the system.

Careful and correct installation is essential for reliable and efficient operation of the network. This is especially important in an age of high-speed networks, which place great demands on the quality of the traffic networks that carry the data. To achieve these goals, you need the help of highly qualified experts who are there for you on a daily basis. After installation is complete, the entire network together with all installed components is checked carefully from top to bottom. The result of the measurements and checks are recorded in protocol form. This information is just as important for your documentation as the network-specific plans and component lists.

HELUKABEL® is certified to ISO 9000. For you, this means you can rely on a well-structured work method that guides the project through every stage to completion.







## Providing you with high-quality services

In addition to supplying network components, HELUKABEL® offers a complete line of services, making us your one stop provider complete, turnkey network solutions and comprehensive service. Our employees have extensive experience working with network components. They are constantly being trained to ensure that they are always informed of the latest developments in this innovative field.

We use high-quality equipment ranging from fibre optic splicing devices to LAN analysers to ensure the best possible performance of your network.

We only use the best components available today. Our collaboration with numerous well-known manufactures of IT components makes it possible for us to provide you with the right selection of components for proper installation of your network.

After installation is complete, the entire network together with all installed components is checked with care. The result of the measurements and checks are recorded in protocol form. This information is just as important for your documentation as the network-specific plans and adresses and component lists.

## Practical training

We provide continuing education and training specially designed to meet the growing demands of the market. Our seminars and workshops provide you with the latest information in the field, giving you the edge you need to succeed in your daily works.

As cable specialist, we are interested in sharing with you the extensive knowledge and expertise we have gained in the field.

We offer seminars covering all theoretical and practical questions concerning copper and fibre optic cables. In the courses, we familiarise you with the installation and correct application of our products to ensure reliable and lasting operation.

In addition, the course provide useful background information for customer-specific solutions as well as practical exercises.

We offer the following standard training courses: Category 5 / 6 / 7 measuring techniques, The basic of fibre optics, Arc lamp splicing devices, OTDR measuring techniques

If you do not find the course you need, we are happy to provide you with a tailored solution to meet your requirements.



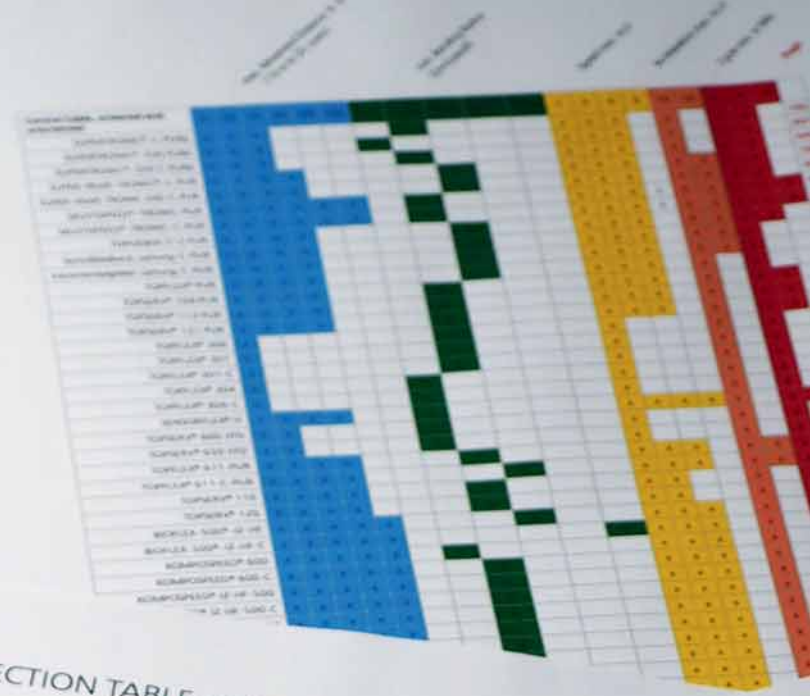
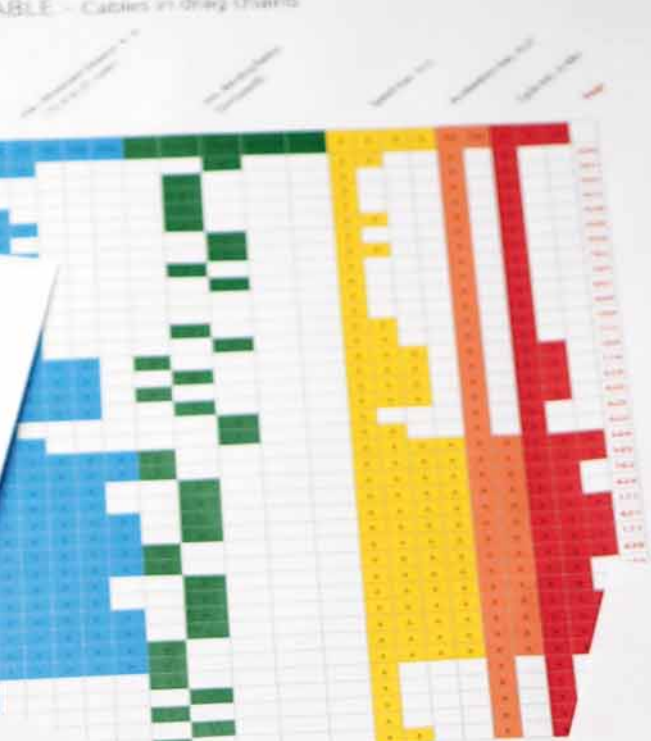

SELECTION TABLE - Cables in drag chains

Index

Part no.	Page	Part no.	Page
11494	50	12328	65
11495 - 11497	52	12345 - 12371	378
11498	60	12372 - 12405	379
11499 - 11500	52	12410 - 12436	378
1501	60	12437 - 12470	379
11502 - 11503	52	12471 - 12517	384
11519	60	12518 - 12543	385
	52	12550 - 12620	389
	60	12630 - 12671	430
	52	12680 - 12722	
	60	12723 - 12746	
		12747 - 12804	
		12805 - 12846	
		12850 - 12877	
		12907	101
			426
			435



SELECTION TABLE - CABLES & WIRES

Torsion cables	UL 10678 / 21179 CE	UL 10269 2570, DRUSA, CE	UL 10269 2570, DRUSA, CE	UL 10269 2570, DRUSA, CE	UL 10553 20234, DRUSA, CE, VDE	UL 10553 20234, DRUSA, CE, VDE	UL 10553 20234, DRUSA, CE, VDE
Wk 103w-T	1000 v	1000 v	1000 v	1000 v	60332-3	60332-3	60332-3
Wk 103w EMV D-T							
Wk 103k-T							
Wk 103k EMV D-Torsion							
Wk 135-T							
Wk 135 EMV D-T							
Wk 137-T FT4							
Wk 137 EMV D-T							
Wk 300w-T							
Wk 305-T							
Wk 7014-T WIND-T							
Wk 101-T							
Wk fire alarm cable-T							
Wk NISICERWOLU-T							
Wk DIO 2-T							
Wk Powerline-T							
Wk THERMIFLEX-T							
Wk (T)							
Tower & Infrastructure							



Questionnaire for energy drag chains

Company \_\_\_\_\_

First name, Name \_\_\_\_\_

Street, No \_\_\_\_\_

Postal Code, Place \_\_\_\_\_

Phone / Fax \_\_\_\_\_

E-Mail \_\_\_\_\_

Installation site \_\_\_\_\_

Kind of machine \_\_\_\_\_

In operation since \_\_\_\_\_

Sender \_\_\_\_\_

**1. Drag Chain-Parameter**

1. Chain length/chain width \_\_\_\_\_ m/mm

2. Chain pitch \_\_\_\_\_ mm

3. Bending radius \_\_\_\_\_ mm

4. Guide stays existing  yes  no

5. Frame stays existing  yes  no

6. layout/installation  horizontal  vertical

**2. Installation and Movement-Parameter**

1. Movement distance (max.) \_\_\_\_\_ m

2. Speeds \_\_\_\_\_ m/s

3. Acceleration \_\_\_\_\_ m/s<sup>2</sup>

4. Frequency per time unit \_\_\_\_\_ x/h

5. Average movement distance/cycle \_\_\_\_\_ h

6. Daily working duration \_\_\_\_\_ h

7. Feeding at mid of moving distance  yes  no

8. Additional weight/chain \_\_\_\_\_ kg

**3. Cable-Parameter**

Cable length (total) \_\_\_\_\_

Enquiry Special Cable

Phone +49 7150 9209-0  
 Fax +49 7150 81786  
 E-Mail: anfrage-spezialkabel@helukabel.de

Enquiry \_\_\_\_\_

yearly requirement approx. \_\_\_\_\_ m

Delivery required \_\_\_\_\_

Size \_\_\_\_\_

Application

a)  indoor  outdoor

b)  stationary  for flexing

c)  Drag chain  speed \_\_\_\_\_ m/s

Temperatures ambient \_\_\_\_\_ °C

Make-up Type of Cable

with reversed bending

Acceleration \_\_\_\_\_ m/s<sup>2</sup>

cyclic  non-cyclic

continuous \_\_\_\_\_ °C

# ■ TECHNICAL INFORMATION

Designation	Page
<b>Basics</b>	
OSI reference model	370
Basics of structured cabling (EN 50173)	371
Structured wiring	372
Wiring topology of industrial application	374
Network topologies in the industrial environment	376
Planning and installation instructions Copper Data Cables	377
Optical transmission characteristics	378
Recommendations for installaing and working with fibre optic cables	379
Installation Guidlines for HCS + POF Cables	382
Patchcables	384
Requirements for office and industrial networks	385
The MICE concept	386
IAONA-classification	387
Characteristics* of insulating and sheath materials	388
Essential cable parameters	390
EN (European) Standards	392
Classification of fibre optic cables / transmission ranges	394
Fibrespecifications	395
Networks and field buses	396
<b>Fibre optics</b>	
Fibre-optic cables-Code	398
Cross-Sections of fibre optics and cores	399
Spectral attenuation characteristic of glass	400
The Electromagnetic Spectrum	401
Fibre optic Drawing Tower-Design	402
<b>Copper</b>	
Code-designation-explanations for cables and insulated wire	403
AWG-Wires and AWG-stranded conductors	404
AWG-Wires (Solid-Conductor)	405
Stranded make-up	406
US-american and british units	407
Copper and Alu-price calculation	408
LAN-Cable designation	409
<b>Plug coding</b>	
RJ45 connector pin assignment for ethernet applikations	410
RJ45 wiring options	411
M12 connector pin assignment	412
<b>Standards</b>	
Standards overview	413
IP-Code (protection classes)	414
Fire performance and fire propagation in accordance with	415
Capacity of KTG-Pool drums	416
UL-Listed or UL-Recognized for data cables?	417
Norm-Glossary	418
<b>Glossary</b>	
Glossary	421
<b>General information</b>	
Part No. Index	438

# ■ OSI REFERENCE MODEL

The communication between systems (devices, computers) in an open network architecture is specified schematically and standardised by the OSI reference model. The individual functions for communication between an application process in one system and any other application in another system are classified in seven functional layers. The complex communication process is simplified by this abstraction and divided into logical units.

A further benefit of this modularisation of the individual function tasks is also the possibility of being able to simply replace the technical implementation of one layer independently from the other layers. For example, it is possible to easily change the transmission medium. The functionality of the other layers is maintained without modification.

## Layer 7 Application layer

(also called: processing layer, application level). The application layer is at the top of the seven hierarchical layers. It provides the applications with a multitude of functionalities (for example, data transmission, email, Virtual Terminal or Remote Login etc.).

## Layer 6 Presentation layer

(also called: data presentation layer, data provision level). The presentation layer converts the system-dependent presentation of the data (for example, ASCII, EBCDIC) to an independent form and thus enables syntactically correct data exchange between different systems. Tasks such as data compression and encryption also belong to Layer 6.

## Layer 5 Session layer

(control of logical connections, session level). The session layer provides services for an organised and synchronised data exchange in order to resolve session crashes and similar problems. For this purpose, restart points, so-called tokens, are implemented, using which the session can be resynchronised after a transport connection failure without having to restart the transmission from the beginning.

## Layer 4 Transport layer

(also called: end-to-end control, transport control). The tasks of the transport layer include the segmentation of data packets and congestion control. The transport layer is the bottom layer which provides a complete end-to-end communication between sender and recipient. It provides standard access to the application-oriented layers 5 - 7 so that these do not need to take account of the characteristics of the communication network. Five differentiated service classes of different quality are defined in Layer 4 and can be used by the upper layers, from the simplest to the most convenient service with multiplexing mechanisms, error protection and error correction methods.

## Layer 3 Network layer

(also called: packet level:). The network layer ensures control of connections for connection-oriented services and the forwarding of data packets for packet-oriented services. In both cases, the data transmission passes over the complete communication network and includes the routing between the network nodes. As a direct connection between the sender and destination is not always possible, packets must be forwarded from nodes which are on the path.

## Layer 2 Data link layer

(also called: connection link layer, connection level, procedure level). The role of the data link layer is to ensure a safe, i.e. transmission as error-free as possible and to control the access to the transmission medium. Splitting the bit data stream into blocks and the insertion of sequence numbers and check numbers are provided for this. Incorrect or lost blocks caused by errors can be requested again by the recipient using acknowledgement and repetition mechanisms. The blocks are also called frames. A so-called flow control makes it possible for a recipient to dynamically control the speed at which the other side is allowed to send blocks.

## Layer 1 Physical layer

(also called: bit transmission layer, physical level). The physical layer is the bottom layer. The specifications for Layer 1 mainly include the mechanical (plug connectors, etc.), electrical (level, type of pulse, etc.) and optical (wavelength) characteristics of the transmission medium (cable, fibre optics, wireless technology etc.).

### OSI reference model

- 7: Application Layer
- 6: Presentation Layer
- 5: Session Layer

#### Application oriented layers

- 4: Transport Layer
- 3: Network Layer

#### Transport Infrastructure

- 2: (Data Link Layer) Logical Link Control (LLC)  
Media Access Control (MAC)
- 1: (Physical Layer)

#### Network hardware

# ■ BASICS OF STRUCTURED CABLING (EN 50173)

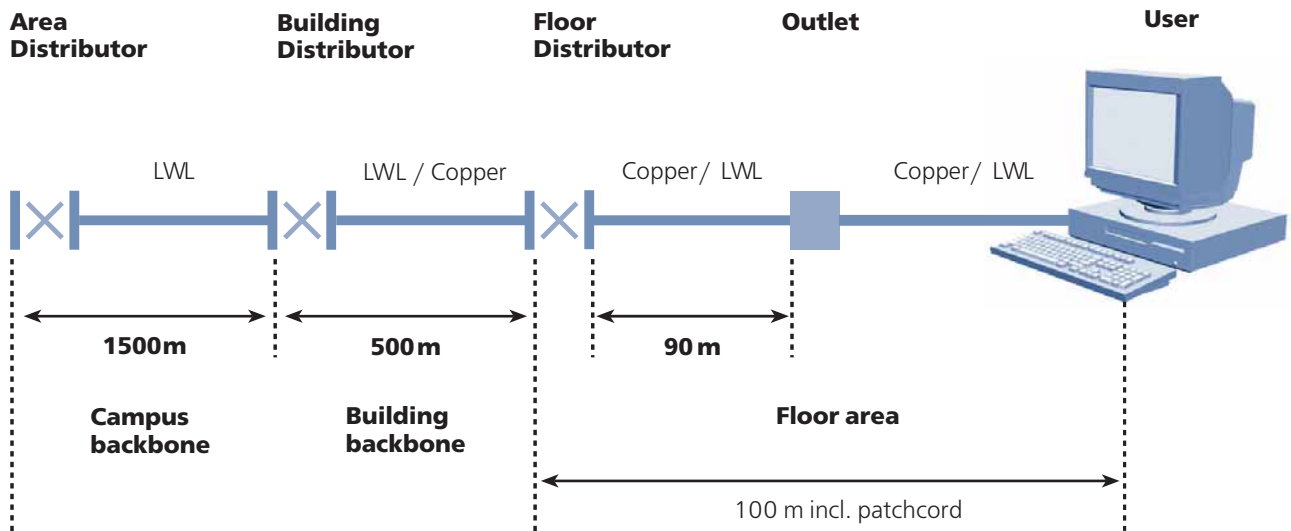

The permanent link and the transmission path (channel) are defined as follows in the ISO/IEC 11801 and EN 50173 standards:

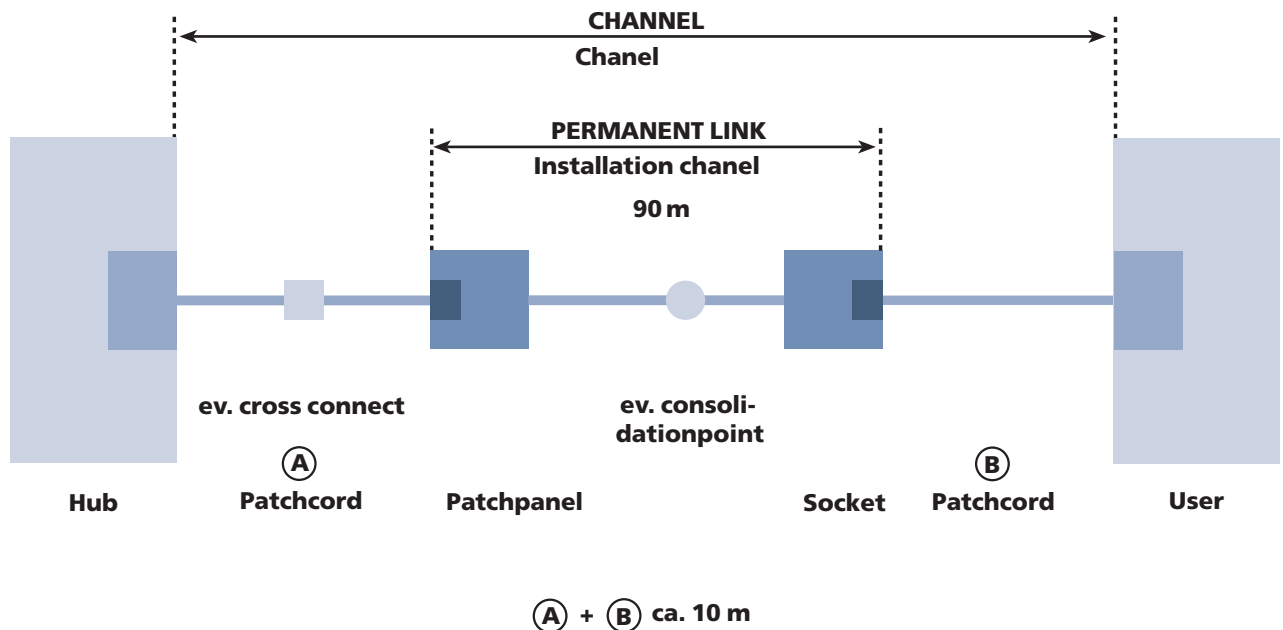

# ■ STRUCTURED WIRING

## Device wiring / Work Area

- **Copper data cables**  
(Chapter 2 HELUKAT®)
  1. U/UTP (UTP\*)
  2. F/UTP (FTP\*)
  3. SF/UTP (S-FTP\*)
  4. S/FTP (S-STP\*)
- **Glas fibre cables**  
(Chapter 1 HELUCOM®)
  1. Installation cables/Zipcord (I-VH)

## Floor Wiring / Horizontal Cables

- **Copper data cables**  
(Chapter 2 HELUKAT®)
  1. U/UTP (UTP\*)
  2. F/UTP (FTP\*)
  3. SF/UTP (S-FTP\*)
  4. S/FTP (S-STP\*)
- **Glass fibre cables**  
(Chapter 1 HELUCOM®)
  1. Breakout-Kabel (z.B. I-V(ZN)HH)
  2. Minibreakout-Kabel (z.B. A/I-VQ(ZN)BH)

## Building backbone/Vertical Cables

- **Copper data cables**  
(Chapter 2 HELUKAT®)
  1. U/UTP (UTP\*)
  2. F/UTP (FTP\*)
  3. SF/UTP (S-FTP\*)
  4. S/FTP (S-STP\*)
- **Glass fibre cables**  
(Chapter 1 HELUCOM®)
  1. Breakout-Cable (z.B. I-V(ZN)HH)
  2. Minibreakout-Cable (z.B. A/I-VQ(ZN)BH)
  3. Loose-tube cable with or without rodent protection (z.B. A/I-DQ(ZN)BH)

\* old description

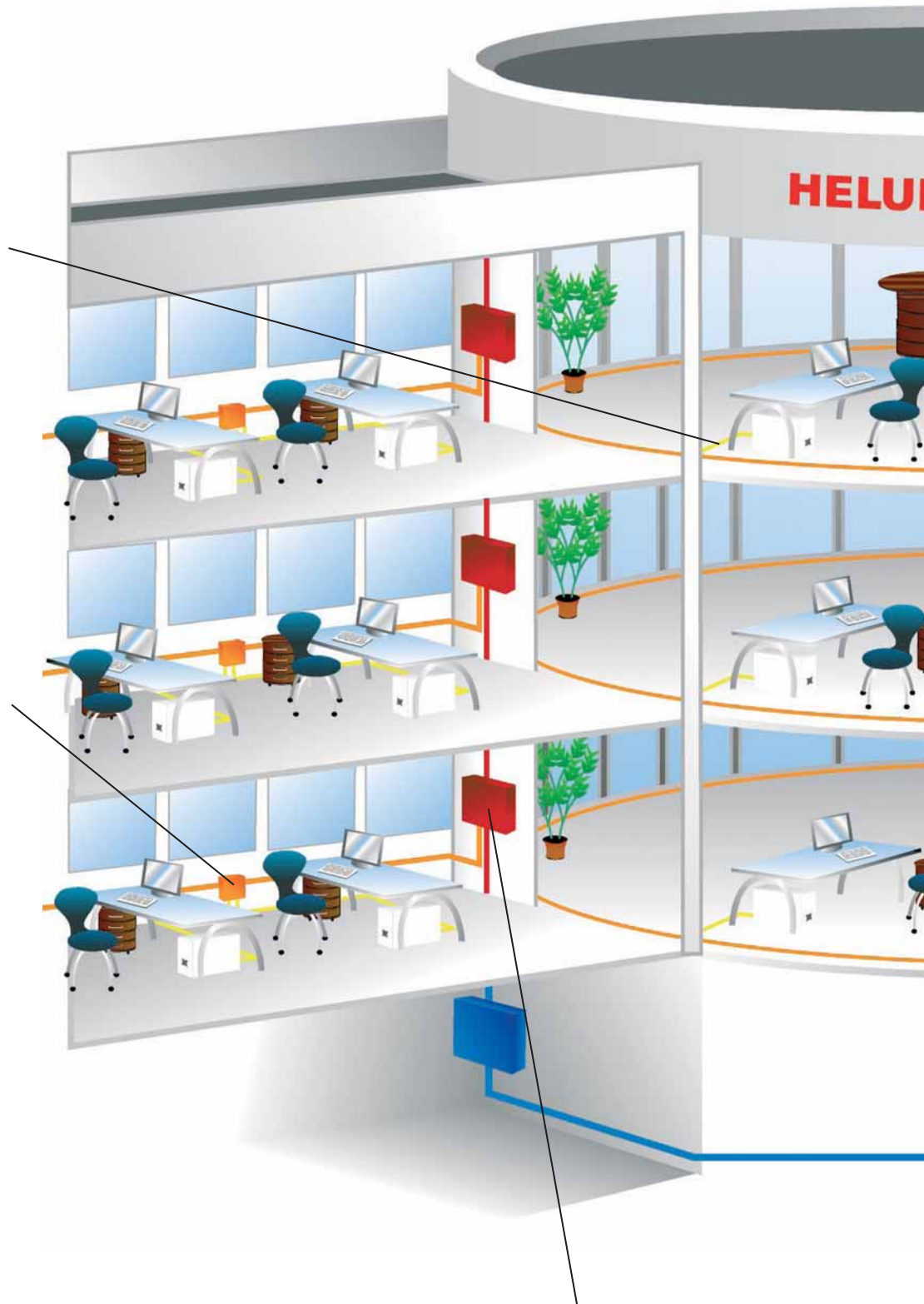

**KABEL**

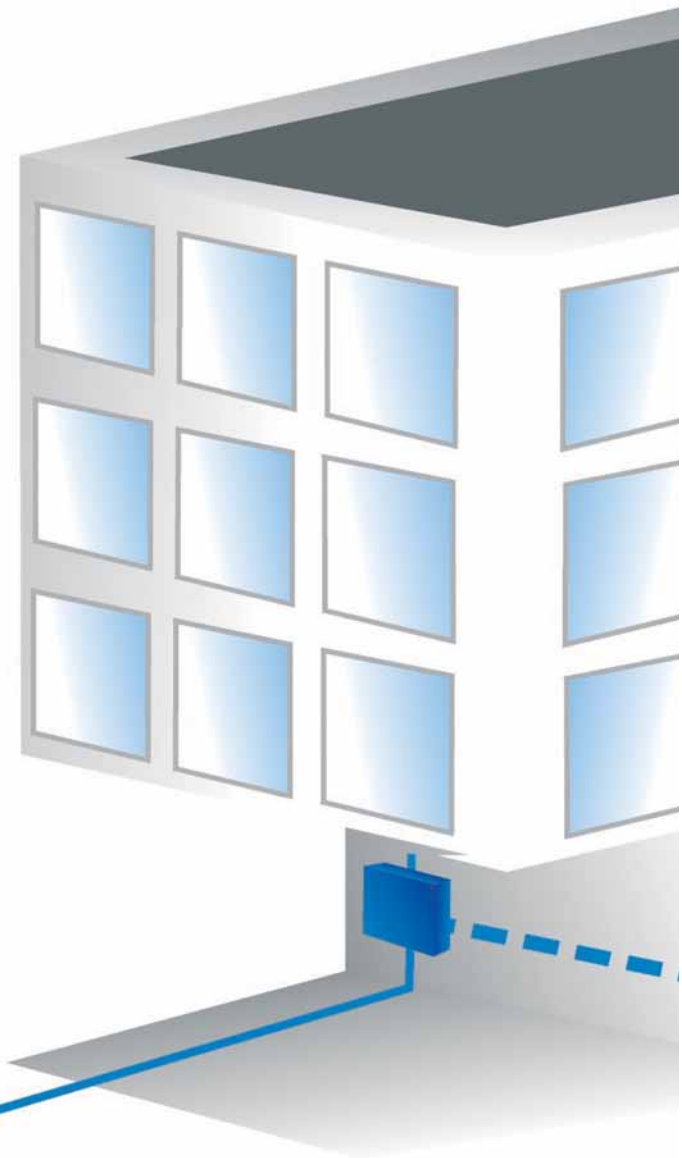
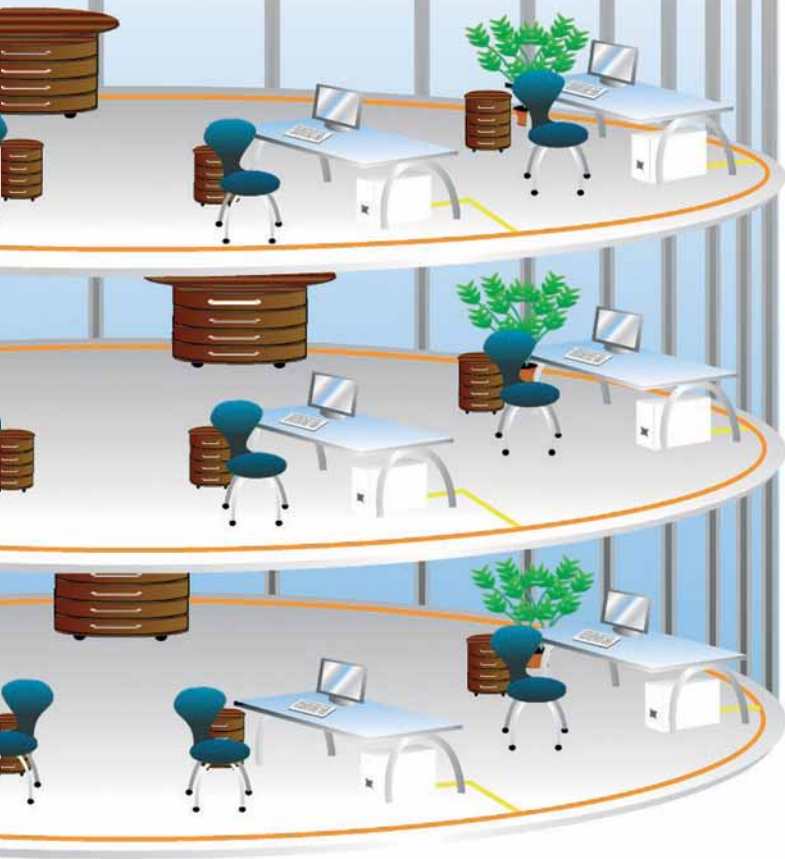

## Campus Cables

### • Glass fibre cables

(Chapter 1 HELUCOM®)

1. Breakout with rodent protection (z.B. AT-V(ZN)HH(BN)2Y)
2. Loose-tube cable with rodent protection (z.B. A-DQ(ZN)B2Y)

### Application:

**These cables are suitable for use with the following LAN standards:**

Ethernet	10 Mb/s
Token Ring	10 Mb/s
Fast Ethernet	100 Mb/s
FDDI-CDDI	100 Mb/s
ATM	155 Mb/s
ATM	622 Mb/s
Gigabit Ethernet	1 Gb/s
10 Gigabit Ethernet	10 Gb/s

# ■ WIRING TOPOLOGY OF INDUSTRIAL APPLICATION

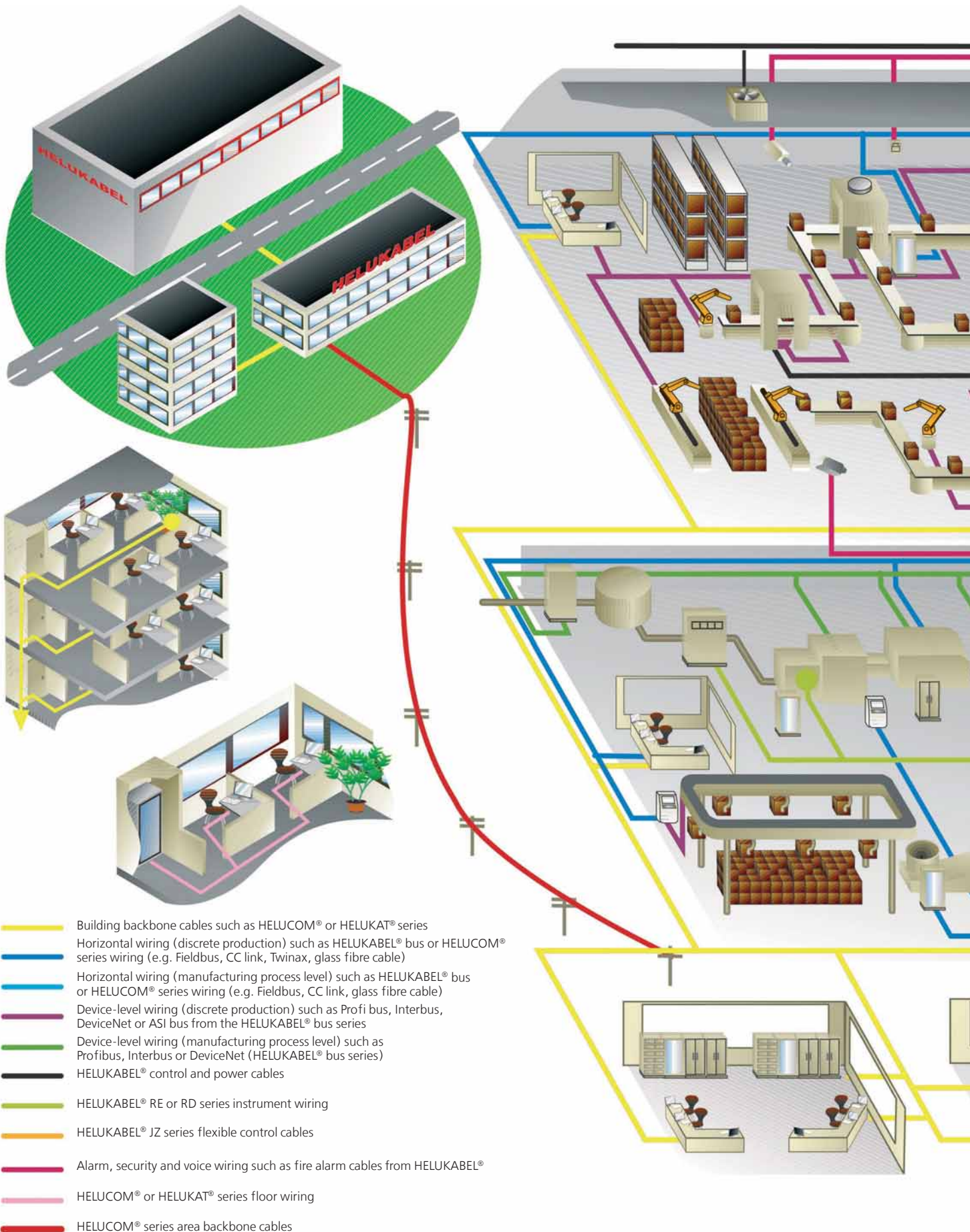



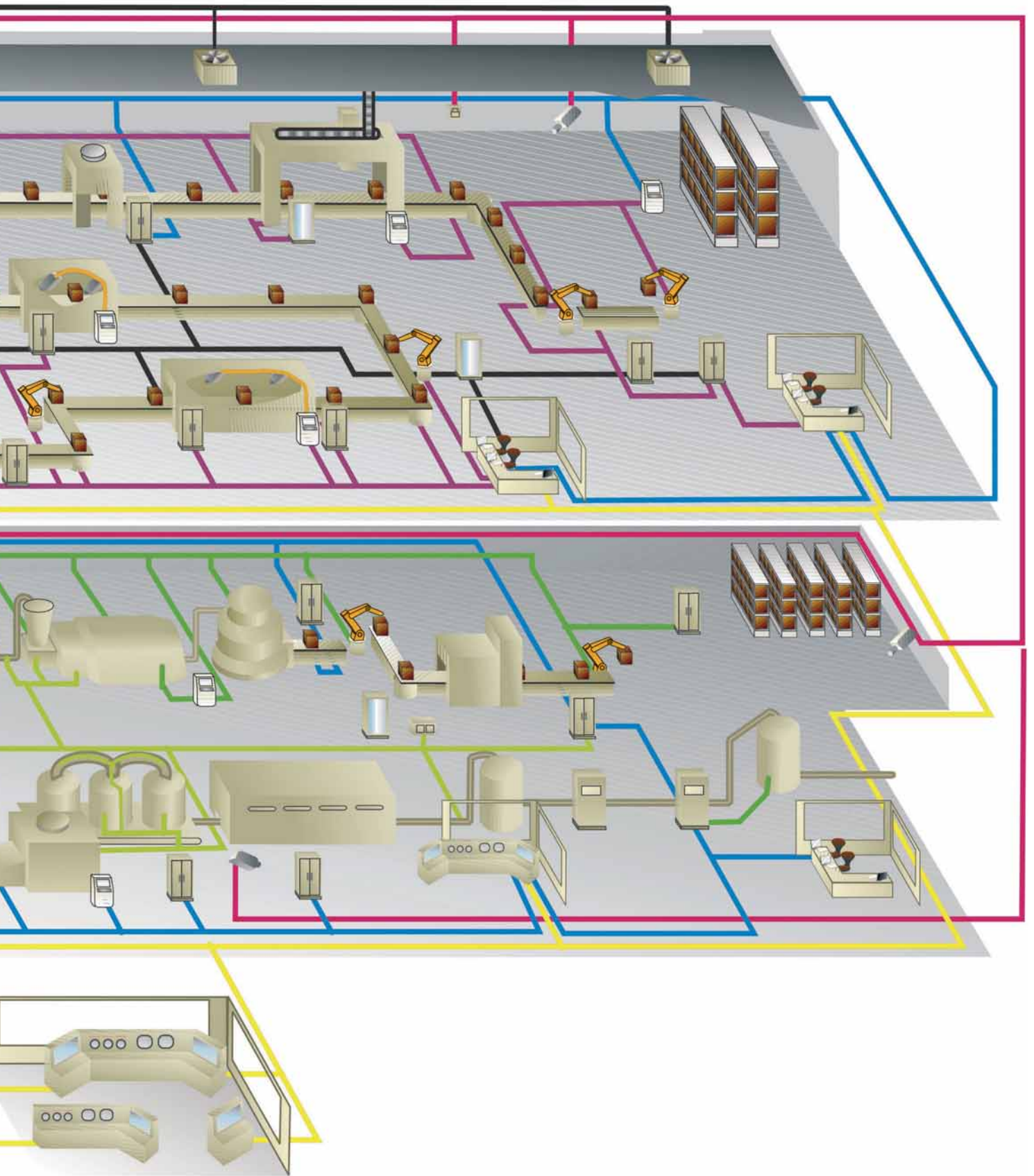

# NETWORK TOPOLOGIES IN THE INDUSTRIAL ENVIRONMENT

The network topologies for Ethernet networks are oriented towards the requirements of the equipment to be networked. The most frequently used are star, point-to-point, tree and ring structures. In practice, a real system often consists of a mixture of the structures considered below.

## Star

The characteristic of the star structure is a central switch with individual connects to all nodes of the network. Applications for star network structures are areas with high node density and low thermal expansion, e.g. small production cells or a single production machine.

SW = Switch  
TE = Terminal Equipment (data terminal)

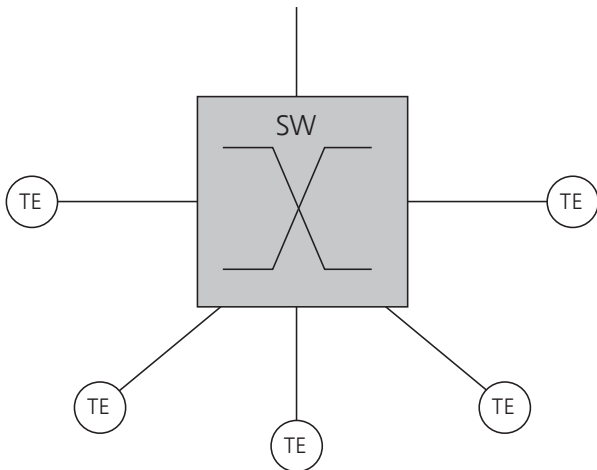

## Tree

The tree topology results from the connection of several stars to a network. It is used for dividing complex systems into subsystems.

## Point-to-point

The point-to-point structure can be realised by a switch in the vicinity of the integrated switch in the node to be connected. The point-to-point structure is preferred for use in systems with remote structure, e.g. conveyor systems and for connecting production cells.

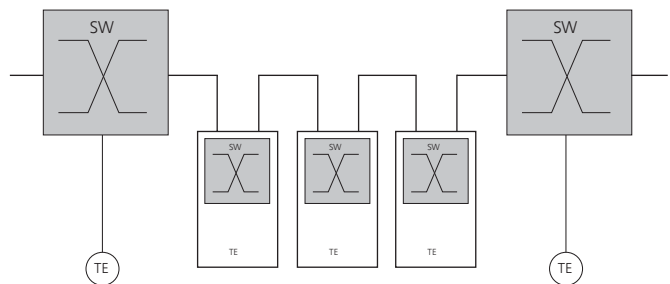

Point-to-point structure  
SW = Switch  
TE = Terminal Equipment

## Ring (redundancy)

A ring structure is produced if the ends of a line are closed with an additional connection. Ring topologies are used in systems with increased availability requirements for protection against cable breaks or failure of network components.

## Example configuration

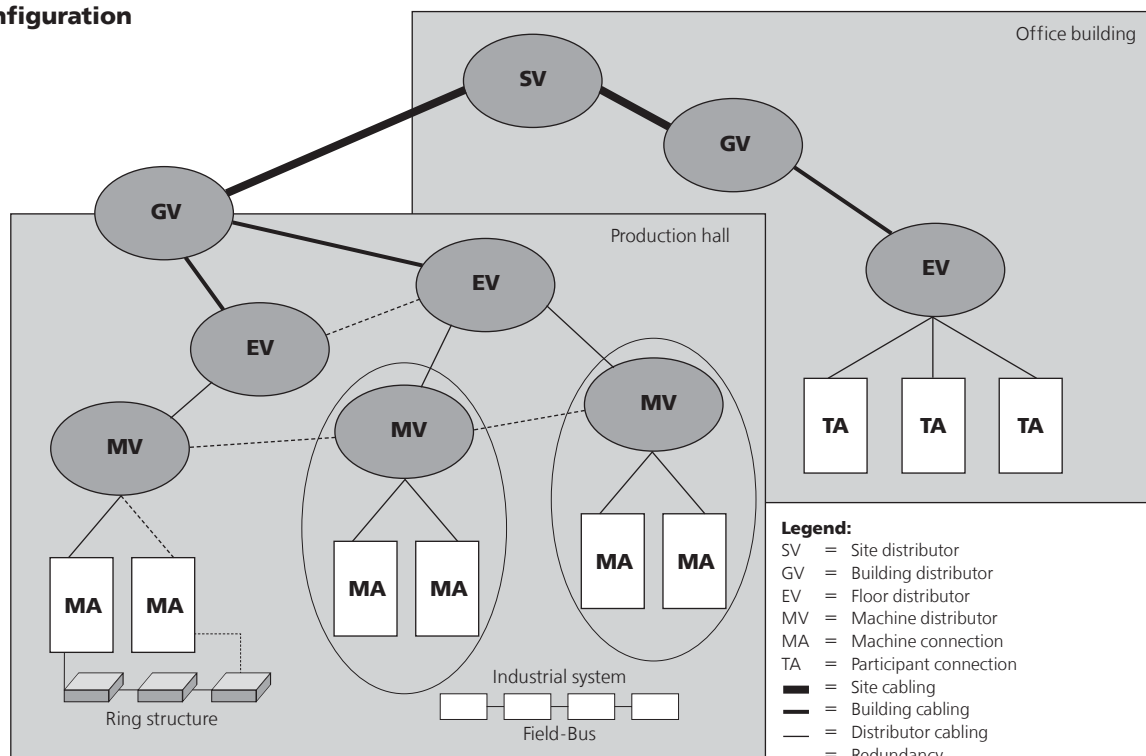

# ■ PLANNING AND INSTALLATION INSTRUCTIONS COPPER DATA CABLES

Fibre optic cable is recommended for execution of the PRIMARY area, whereby the site distributor is usually connected to the individual building distributors in a star configuration.

The SECONDARY area can be laid out with fibre optic, as well as with copper cable, (fibre optic is recommended and the structure can be either a star configuration or a ring configuration).

The TERTIARY area is executed in a star configuration with copper cable.

The minimum cable structure recommendation is 4 pair with a conductor cross-section of 0.51 mm that is covered with foil shielding. However cable with foil shielding for each pair, and overall braid screening is preferred in order to also handle future applications and requirements. (Higher near-end crosstalk attenuation and better EMC behaviour).

Halogen-free cable is recommended for buildings with higher concentration of material assets or personnel. The system reserves in the type selection should be specified for a service life of 10-15 years. Ensure that all components contained are either screened or non-screened. Existing standards facilitate execution and increase security, and they should be strictly complied with. Due to the high cable density in the tertiary area, sufficiently dimensioned cable routes must be planned.

## Installation instructions

Note that in the tertiary area, the max. cable length between floor distributors and the workstation wiring box is 90 m. (Ethernet according to 802.3, Copper).

Ensure that earthing is carefully equalised. The earth potential difference between any earthing points should not exceed 1 volt.

Ensure that power cables and data cables are separated by a metallic centre web if laid in shared cable routes.

Ensure that the cables are used in enclosed and dry areas and that the cable routes are protected from aggressive chemicals and rodents.

An adjacent fire barrier is required for floor penetrations for the riser line.

## Cable installation guidelines

Never take cable and lines from a reel against their original run direction (Fig. 1); turn around (Fig. 2) is also not permitted. When installing cable, the reel should always be horizontal (Fig. 3), preferably it should be placed on a roll dispenser. This is the only way to ensure that the cable is laid on the ground without incurring damage due to mechanical stress.

In order to avoid a crossover effect with cable rings, they should always be positioned vertically (Fig. 4) and unrolled onto the ground. If cable cannot be unrolled in the required length due to a lack of space, then you must maintain a bend of sufficient dimensions when running back. If, for example, multiple cables are routed parallel in the same channel, then we recommend bundling them using cable ties or insulation tape. The bundle should always be laid out straight to avoid possible jamming when installing.

## Tensile stress during and after the installation

Data lines should only be exposed to low level mechanical stress. In the relevant guidelines, 5daN/qmm Cu-conductor is specified as maximum permissible tensile force. This results in the following permissible tensile stress values depending on number of pairs and execution of the overall screen:

Conductor	Ø	without screened braiding		with screened braiding	
		2 pair	4 pair	2 pair	4 pair
AWG26/7	7 x 0.16	3 daN	6 daN	7 daN	10 daN
AWG24	0.51	5 daN	9 daN	9 daN	15 daN
AWG23	0.55	-	-	13 daN	19 daN
Ø 0.6	0.60	7 daN	12 daN	16 daN	24 daN
AWG22	0.64	8 daN	15 daN	17 daN	25 daN

(1daN corresponds to approximately 1kg)

Ensure that the cable is not pulled too forcefully when bending around sharp corners or edges. Excessive mechanical stress can influence the transmissions properties. The **bend radius** must not exceed **8 times** the cable diameter while subject to tensile stress. In installed condition this value can be reduced to **4 times** the cable diameter.

In the design as well as in the production of HELUKAT® lines, care has been taken to achieve cable structure that is as solid and compact as possible, so that no essential losses occur in the transmission parameters if these installation guidelines cannot be complied with due to local conditions.

## Patch cable

The calculation of the maximum. Patch Cable Length = flexible printed circuit, calculated using the formula below. It follows with optimal conditions, a max. 80 m flexible Section (AWG 22, 7-wiry, FM45 industrial connectors, Profinet-B). This patch cable is a channel for a complete route. After installation, it is absolutely necessary to carry out a measurement.

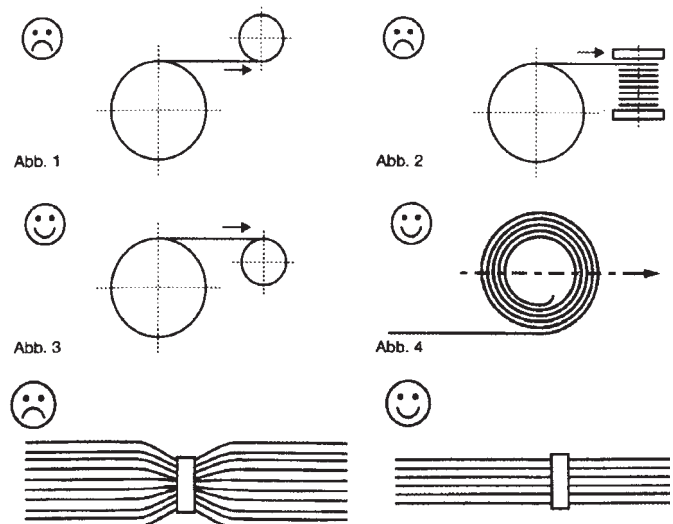

# ■ OPTICAL TRANSMISSION CHARACTERISTICS

## Optical transmission characteristics

**There are two main factors which determine the optical quality of the fibre optic cable: attenuation and bandwidth**

These transmission parameters are always specified for two operating wave lengths (optical windows):

**Multimode G50 and G62.5/125  $\mu\text{m}$  -> 850 and 1300 nm**  
**Singlemode E9/125  $\mu\text{m}$  -> 1310 and 1550 nm**

The attenuation characteristic describes the loss in intensity of the light signal sent via the fibre and is specified as fibre attenuation in dB/km. The bandwidth is a unit of measurement for the dispersion characteristic of the fibre optic cable and is expressed in MHz\*km; for singlemode fibres it is the dispersion coefficient in ps/nm\*km.

A fibre optic cable with a bandwidth-length product of 1200 MHz\*km features an impressive usable bandwidth of 2.4 GHz over 500 m. Unlike transmission via copper, transmission via glass does not involve any compromising of the digital signals. As a result, bandwidth and transmission speed are the same: Hz = bit/s.

In addition to the bandwidth-length product, the beginning of the Gigabit age has also made an additional characteristic of multimode fibres important. The guaranteed Gigabit length in m is measured using a special method defined in the standard FOTP 204.

When planning the lengths of fibre optic cables, it is important to consider these three important transmission parameters for the calculations. Of course, it's not always necessary for the fibres to meet the highest standards in terms of optical transmission parameters. In secondary and tertiary cabling, in particular, it is uncommon to exceed lengths of 400 m. In these cases, it is often possible to settle for a lower specification without sacrificing performance or investment security. When it comes to pigtailed or patch cables, the bandwidth and attenuation no longer play a role for the optical quality. At lengths of up to 10 m, these cables have almost unlimited bandwidth, and the attenuation is limited by the connectors – not the fibre between them.

With the incredible rate of progress in IT, the question of "which fibre type?" and, by extension, "what transmission capacities?" has grown in importance. In the multimode range, the answer is clear. The 50  $\mu\text{m}$  fibre is technically far superior to the 62.5  $\mu\text{m}$  in every respect. In the smaller optical core, far fewer discrete modes propagate, with the result of less attenuation, higher bandwidths, and higher Gigabit distances. When it comes to costs, the meter price of 50  $\mu\text{m}$  cable is actually lower. With the latest development, transmission of up to 10 Gbit/s by means of wavelength multiplexing, singlemode fibre is becoming increasingly important. With just a single mode, great distances and almost unlimited bandwidths are possible. The manufacture of the E9/125 is less complex, and as a result more affordable than that of a multimode fibre.

## Jacket materials

There are two materials that are in widespread use for jacketing fibre optic cables: polyethylene PE and halogen-free, flame resistant material (Flame Retardant Non Corrosive).

The only real difference between universal cables and outdoor cables is the halogen-free, flame resistant jacket of the universal cables. The great advantage with universal cables is that there is no need for an interface between outdoor cables and indoor cables where the cables enter the building. This eliminates the need for time consuming, costly splicing work. However, when laying universal cables it should be kept in mind that these must be pulled into HDPE conduits which have been sealed against moisture ingress on both sides of the building. This is because there is one clear difference between the FRNC jacket and the PE jacket. The halogen-free, flame-resistant jacket does not come close to providing the level of protection offered by PE against lateral diffusion of water.

## Armouring

Rodents can pose a hazard in easily accessed conduits or shafts. In these environments, the cables must be provided with armour, to protect them against the rodents' natural gnawing instinct. If the cables happen to block the path of the rodent, the rodents will attempt to gnaw through the problem cable. In general, there are two options: a metallic or non-metallic armour against rodents. The first is a corrugated steel jacket, and the second is a glass roving wrap.

Tests on the rodent-resistance of fibre optic cables have shown that the two types of armour are not equally effective. Cables with a glass roving armour had clear signs of damage after some time, indicating that there would be a negative effect on the transmission performance in the long term. The corrugated steel jacket, on the other hand, was unaffected by the rats. Based on these test results from an independent institute, it is essential to inspect the cable routes when planning the installation of fibre optic cable systems.

An additional important criterion when selecting fibre optic cables is the whether the cable is free of metal. If there is metal in a dielectric cable, it must be completely electrically insulated: i.e. in accordance with DIN VDE 0800, one end of the metal armouring, always in the direction of the main distributor, must be laid on the earthing bar in the distribution cabinet. This additional work can be eliminated if the metal layer is sealed off at the mouth of the cable, for instance with a shrink sleeve. This ensures that in the case of contact, electrostatic discharge would not pose any health hazard for humans.

# RECOMMENDATIONS FOR INSTALLING AND WORKING WITH FIBRE OPTIC CABLES

## Introduction

Cable configuration has the purpose of protecting the fibre optic cable during transport, storage, installation and operation. During each of these stages, the cable is exposed to different influences, such as mechanical stress, different temperatures, humidity, and sunlight.

The cable will function reliably in the environment for which it was designed. For example, a cable for underground installation is not suitable for use as an aerial cable. The cable configuration and the materials have been specially selected to ensure that the specified transmission characteristics continue to be fulfilled throughout the service life of the cable. In addition to the cable configuration, the quality of the professional installation or assembly of the cables also is an important factor for ensuring the transmission characteristics over the long term.

## General information

Cables which are stored in unsupervised areas should be protected against vandalism and other potential sources of damage. If there is an interruption during installation, e.g. a break is taken overnight, be sure to protect the cable ends against moisture ingress. Corresponding warning tape should be integrated as part of the installation work. Comply with local ordinances and customer specifications.

## Transport and storage

Cable drums should be handled with care during loading and unloading. Always use a suitable forklift or crane to load the drums. Check the drums for any damage (e.g. broken flange, protruding nails, etc.) to prevent later cable damage during the installation.

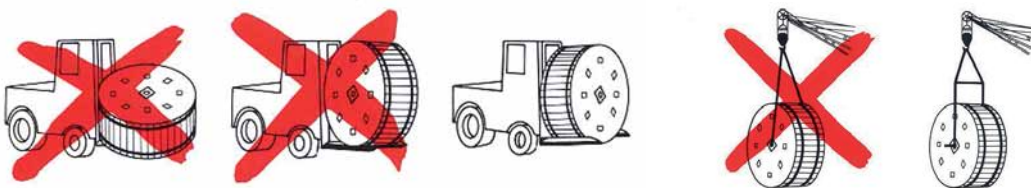

Drums of fibre optic cable must always be kept upright during transport. Check that the roll direction is correct (arrow on the drum) to prevent the reel of cable from loosening. Secure the cables during transport. (loading safety)

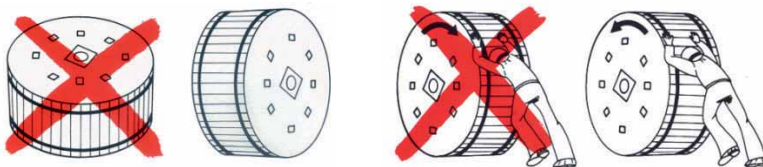

If the cable will be stored for a longer period, we recommend protecting the cable against continuous sun exposure. Use suitable caps to protect the cable ends from moisture ingress.

## Installation instructions

Observe the cable specification sheets. These contain all of the important information for the installation:

- Minimum bending radius with and without tensile load
- Maximum tensile force
- Minimum and maximum installation temperature
- Maximum transverse pressure

The permissible bending radius depends on the cable configuration. Compliance with the minimum bending radii protects the cable configuration against damage from excessively tight bends during installation and during later operation, ensuring long-term operating reliability.

**Important,** when using wheels to redirect the cable, each individual wheel must meet the specified minimum bending radius.

# RECOMMENDATIONS FOR INSTALLING AND WORKING WITH FIBRE OPTIC CABLES

The maximum permissible tensile force is defined by the strain relief elements in the cable, and is specified so that below this maximum force, the fibres are not subjected to any continuous elongation, which could damage the fibres.

The specifications for the minimum and maximum installation temperature refer to the temperature of the cable and not to the ambient temperature. This means that at low ambient temperatures, the cable can be heated in advance, or in the case of excessive ambient temperatures, be cooled in advance. The heating or cooling phase can range from a few hours up to 24 hours, depending on the cable type, cable length, and the size of the drum. Excessive transverse pressure can damage the cable core and negatively affect the service life of the fibres.

## Laying the cable directly in the ground

When laying cable directly in the ground, without a conduit, make sure that the cables are lying in sand bed, free of stones. Make sure that the cable is at the correct distance from other supply lines and cables.

## Ploughing

Fibre optic cables that are ploughed in must be suitable for this installation method.

## Drawing cable into conduits

If the cable will be drawn in, make sure that all strain relief elements are equally subjected to the tensile load. The pulling grips must be designed for the respective cable type (tensile force, diameter). For stranded cables without glass or Aramid fibre roving over the cable core, it is important that the central strength member takes part in the pulling. We offer high tensile strength capping as an option.

**Important**, the pulling equipment must be equipped with a tensile force limiter, which stops the pulling process if the maximum tensile force is exceeded. The tensile forces must be documented over the entire pulling process. To avoid torsion, use anti-twist ropes and swivel shackles.

If the cables will not be directly pulled from the cable, the cable must be laid out in a figure-eight configuration. Take care to comply with the permissible bending radii.



Wrong



Correct

When using lubricants, make sure that these have been approved by Deutsche Telekom (ZTV-TKNetz, Part 40) or are of equal or higher quality. The use of mechanical "figure eight machines" is often problematic, as many of these machines do not monitor the bending radius.

# ■ RECOMMENDATIONS FOR INSTALLING AND WORKING WITH FIBRE OPTIC CABLES

## **Blowing**

The alternative to the pulling method is to install the cable using the air blown method. Keep in mind that not every duct is suitable for every cable type. The tube and cable diameters must be designed for each other.

Due to their design, microduct cables are only suitable for use in microduct tubes.

With the blowing method, it is possible to blow a second or even a third cable into standard ducts that already contain a cable. However, for the second and third cable, the blowing distance will be shorter. With modern blowing equipment, depending on the routing, it is possible to blow in cable of up to several kilometres in length. The blowing result depends on correctly matching all elements of the blowing equipment (blowing jets, post-cooler, compressor) to the cable to be installed, and is also highly dependent on the qualifications of the operating personnel. For this reason, we recommend having the personnel trained by the respective device manufacturer.

Before starting the blowing process:

- Check the conduit system with a gauge
- Blow a foam carrier through the conduit to clean and pre-lubricate it. Make sure that the lubricant is dosed correctly (see manufacturer specifications)
- Perform the crash test The crash test determines the maximum contact pressure of the blowing machine.

**Important:** The simultaneous introduction of lubricant during the process should only take place downstream from the drive (worm gear, drive wheel) of the blowing machine.

For each cable diameter, there are blowing caps for rounding off the cable end. The use of these caps is obligatory.

Blowing central loose tube cables into conduits is a special case. For the wide conduit diameter, these cables are not really stiff enough to achieve acceptable blowing lengths. To improve the blowing performance, it is necessary to use aids. End caps are available in various sizes for the different tube diameters. With the use of end caps, blowing lengths of 2 km can be achieved, even with central loose tube cables.

## **Aerial cables**

Aerial cables are specially designed to be suspended from poles. The design takes into account the increased tensile forces as well as additional loads such as those from wind and ice. Aerial cables are always specially designed for the given project, as conditions will vary depending on the site of operation. For aerial cables, the strain relief elements must be made of Aramid yarns. Glass rovings should not be used. When laying the aerial cables, take care to comply with the maximum tensile forces as well as the specified minimum bending radii. This is especially important for multiple rolls. Each individual roll must meet the specified minimum bending radius.

Furthermore, the fixtures in use must be designed for the cable. Fixtures that are not seated correctly can reduce the service life of the cable and also result in hazards due to excessive sagging or even falling cable. Preformed spiral fixtures are recommended, as these provide a secure hold with only minimal load on the cable.

## **Tools ideal for processing cables and fibre optics**

When further processing the cables, be sure to use suitable tools, such as: Bevel type cable cutter, fibre optic cleaver, coating stripper, tube splitter

# ■ INSTALLATION GUIDELINES FOR HCS + POF CABLES

## Installation Guidelines for Polymer Fiber Cables (980/1000µm)

### Do Not Exceed Maximum Cable Lengths

- When installing polymer fiber cables, the maximum cable length of 50 or 70 m (depending on the fiber optic system used) between two devices must not be exceeded. The cable length can be further reduced using special cables or joints.

### Do Not Use Cables Shorter Than the Permitted Minimum Lengths

- Fiber optic cables that are shorter than 1 m can result in the receiver being overcontrolled. Only use cables longer than 1 m.

### The Bending Radius Must Be Maintained

- Please ensure that the minimum bending radius is no smaller than the given data/ standard. This is particularly important if fiber optic cables are led through housing or installed in right angle cable ducts.

### Do Not Exceed Tensile Load and Lateral Strength

- The permanent tensile load of a polymer fiber cable must not exceed the maximum standard.
- Squeezing the cable, for a period longer than just stepping on it, must be avoided (attend to the maximum lateral strength).

## Installation Guidelines for HCS Cables (200/230 µm)

### Do Not Exceed Maximum Cable Lengths

- When installing HCS cables, the maximum cable length of 300 or 400 m between two devices must not be exceeded.

### The Bending Radius Must Be Maintained

- Please note that the bending radius must not fall below the minimum value. This is particularly important if fiber optic cables are led through housing or installed in right angle cable ducts.

### Do Not Exceed Tensile Load and Lateral Strength

- The permanent tensile load of an HCS cable must not exceed maximum standard.
- Squeezing the cable, for a period longer than just stepping on it, must be avoided (attend to the maximum lateral strength).

## Installing HCS- + POF-Cables

### Use an Uncoiling Device to Uncoil the Fiber Optic Cable

- The fiber optic cable must only be uncoiled from the cable drum using an uncoiling device.

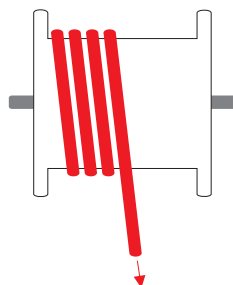

### Do Not Twist the Cable

- With short cable runs, avoid twisting the cable (torsion).

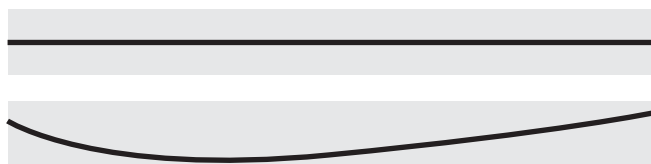

### Insert the Fiber Optic Cable Correctly

- Do not pull the cable by the individual fibers. Do not pull the cable forcefully if the cable becomes caught. If you install the fiber optic cable using a cable-pulling device you must secure the device to the strain relief (e.g., aramide yarn).

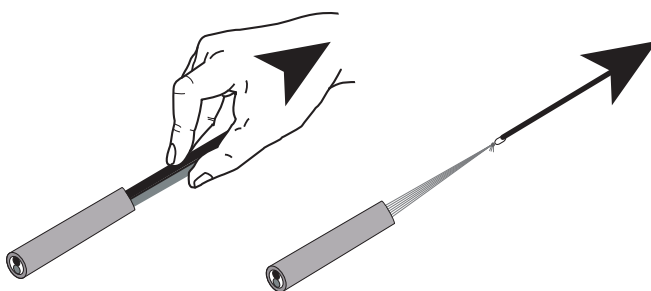

### Install Cables in Cable Ducts

- Install the cables in cable ducts without loops.

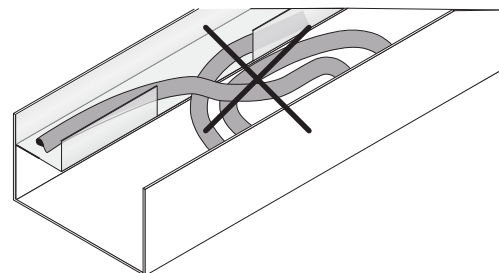



## ■ INSTALLATION GUIDELINES FOR HCS + POF CABLES

### Install Fiber Optic Cables Separately

- Fiber optic cables are installed in cable ducts or cable conduits. If these cables are installed in ducts together with heavy power cables, the fiber optic cables should be installed in a separated area of the duct or as the uppermost cable. This is to protect fiber optic cables against increased bending and tensile loads.

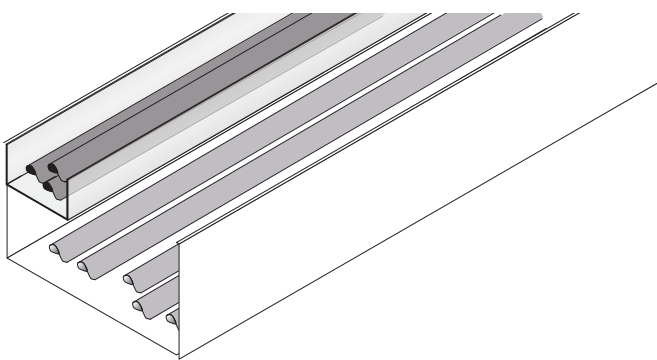

### Protect Fiber Optic Cables from Sharp Edges

- Protect the fiber optic cables from sharp edges. Insert an edge protector. Smooth or remove any sharp edges.

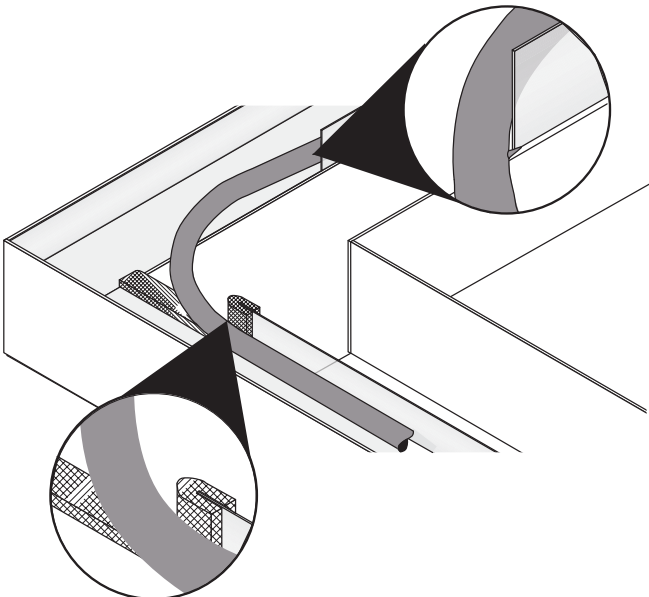

### Secure the Bending Radius: Cable

- If the fiber optic cable has to be installed at a right angle, secure it with cable binders. This prevents the bending radius falling below its permissible range.

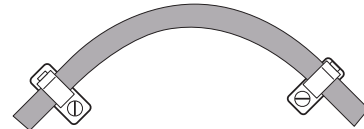

### Do Not Squeeze Fiber Optic Cables When Securing

- When securing cable binders, clamps, and control cabinet inlets, ensure the cable is not squeezed.
- Preferably use plastic fastening elements with a large surface to avoid squeezing.
- The fastening elements must have a width of at least 5 mm and should be carefully tightened manually.

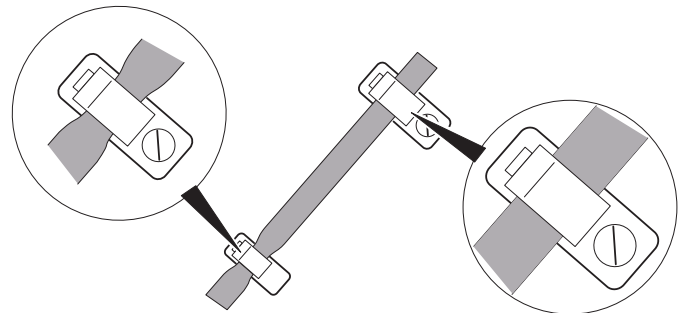

# PATCH CABLES

EN 50173-3:2007

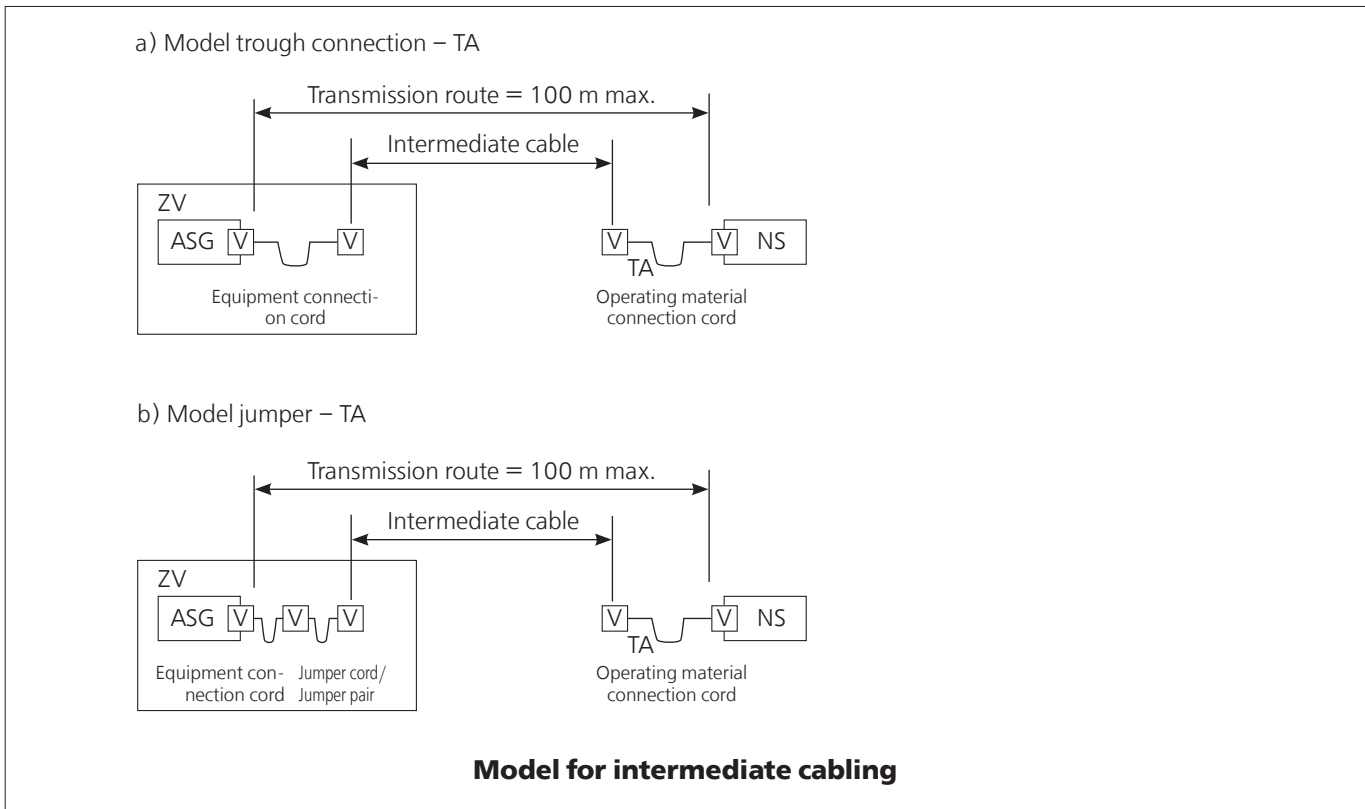

## Equations for the transmission routes of intermediate cabling

Model	Image	Model equation		
		Class D	Class E	Class F
Through connection – TA	a)	$H = 109 - F \times X$	$H = 107 - 3^a - F \times X$	$H = 107 - 2^a - F \times X$
Jumper ring – TA	b)	$H = 107 - F \times X$	$H = 106 - 3^a - F \times X$	$H = 106 - 3^a - F \times X$

$H$  largest length of the intermediate cable (m).

$F$  total length of the jumper cable, jumper pairs, operating material connection and equipment connection cords (m).

$X$  Ratio of damping of flexible cables (dB/m) to the damping of permanently installed intermediate cables (dB/m) – see section 9 (> 1)

<sup>a</sup> The length reduction represents an allocated reserve to consider the insertion damping variations.

For operating temperatures above 20 °C,  $H$  must be reduced by 0.2% for shielded cables and by 0.4% for unshielded cables for each °C (20 °C to 40 °C) and by 0.6% for each °C (> 40 °C to 60 °C). The documents of the manufacturer or the supplier must be consulted if the intended operating temperature exceeds 60 °C.

The following general restrictions apply:

- The physical length of the transmission distance must not exceed 100 m;
- the physical length of the intermediate cable must not exceed 90 m and – depending on the cord used and the number of plug connection – it can be less;
- the individual length of the jumper cords or jumper pairs must not exceed 5 m.

The largest length of the intermediate cable depends on the total length of the cord, which must be supported on a transmission route.

An administration system must be installed during the operation of the installed cabling to ensure that the cords used for the generation of the transmission route are in accordance with the draft rules for the floor, the building or the installation.

# ■ REQUIREMENTS FOR OFFICE AND INDUSTRIAL NETWORKS

The international standard ISO/IEC 11801 and its European equivalent EN 50173 define an application-neutral, standard IT networking for a building complex. Their contents are largely identical. Both standards assume an office environment usage of the building and require application neutrality. The specific requirements for Ethernet networks in industrial environments such as:

- system specific cable layout
- individual connectivity for each machine / system
- point-to-point network structures
- robust industry-compatible cables and plug connectors with particular requirements for EMC, temperature, moisture, dust and vibration are not considered in both these standards. The comparison is below:

	Office area	Production and field area
<b>Installation conditions</b>	<ul style="list-style-type: none"> <li>• fixed basic installation in the building</li> <li>• laying in false floors</li> <li>• variable equipment connection at the work place</li> <li>• prefabricated equipment connection cables</li> <li>• mainly standard work places (desk with PC, ...)</li> <li>• tree-shaped network structures</li> </ul>	<ul style="list-style-type: none"> <li>• strongly system-dependent cabling</li> <li>• system specific cable layout</li> <li>• connection points are seldom changed</li> <li>• equipment connections can be assembled in the field</li> <li>• each machine / system requires individual connectivity</li> <li>• frequent point-to-point network structures and (redundant) ring structures</li> </ul>
<b>Transmission performance</b>	<ul style="list-style-type: none"> <li>• big data packets (for ex. pictures)</li> <li>• medium network availability</li> <li>• transmission time in seconds range</li> <li>• high proportion of not cyclic transmission</li> <li>• no isochrony</li> </ul>	<ul style="list-style-type: none"> <li>• small data packets (measured values)</li> <li>• very high network availability</li> <li>• transmission time in microseconds range</li> <li>• high proportion of cyclic transmission</li> <li>• isochrony</li> </ul>
<b>Environmental requirements</b>	<ul style="list-style-type: none"> <li>• moderate temperatures</li> <li>• low dust contamination</li> <li>• no moisture</li> <li>• hardly any vibration</li> <li>• low EMC load</li> <li>• low mechanical hazard</li> <li>• low UV radiation</li> <li>• hardly any chemical hazard</li> </ul>	<ul style="list-style-type: none"> <li>• extreme temperatures</li> <li>• high dust contamination</li> <li>• possible moisture</li> <li>• vibrating machines</li> <li>• high EMC load</li> <li>• risk of mechanical damage</li> <li>• UV exposure outdoors</li> <li>• chemical contamination by oily or aggressive atmospheres</li> </ul>

# THE MICE CONCEPT

## The MICE concept – explanation using cabling solutions as an example

**M**echanical                      Mechanical properties  
**I**ngress                            Leak tightness properties  
**C**limatic                           Climatic properties  
**E**lectromagnetic                Electromagnetic properties

cables used in the industrial environment is crucially important for a fault-free and above all, reliable operation of communication and data networks.

In contrast to the cables used in the office environment, the selection of the correct insulation material for communication

First drafts of the future cabling standard show an interesting approach which could help the user with the selection of the correct cable.



	<b>M<sub>1</sub></b>	<b>M<sub>2</sub></b>	<b>M<sub>3</sub></b>
<b>Mechanical properties</b>			
Impacts (maximum acceleration)	40 ms <sup>2</sup>	100 ms <sup>2</sup>	250 ms <sup>2</sup>
Vibrations (oscillation amplitude 2-9 Hz)	1,5 mm	7,0 mm	15,0 mm
Vibrations (acceleration amplitude 9-500 Hz)	5 ms <sup>2</sup>	20 ms <sup>2</sup>	50 ms <sup>2</sup>
Tensile force	see note*	see note*	see note*
Pressure	45 N over 25 mm (linear) min.	1.100 N over 150 mm (linear) min.	2.200 N over 150 mm (linear) min.
Impact	1 J	10 J	30 J
Torsion	see note*	see note*	see note*
<b>Leak tightness properties</b>	<b>I<sub>1</sub></b>	<b>I<sub>2</sub></b>	<b>I<sub>3</sub></b>
Particle entry (max. diameter)	12,5 mm	50 µm	50 µm
Immersion	none	Liquid spray interval ≤12-5 l/min/≥6,3 mm spray/>2-5 m distance	Liquid spray interval ≤12-5 l/min/≥6,3 mm spray/>2-5 m distance and immersion (≤1m for≤30 minutes)
<b>Climatic properties</b>	<b>C<sub>1</sub></b>	<b>C<sub>2</sub></b>	<b>C<sub>3</sub></b>
Ambient temperature	-10°C to +60°C	-25°C to +70°C	-40°C to +70°C
Rate of temperature range	0,1°C per Minute	1,0°C per Minute	3°C per Minute
Humidity	5% - 85% (non-condensing)	5% - 95% (non-condensing)	5% - 95% (non-condensing)
Solar irradiation	700 Wm <sup>2</sup>	1120 Wm <sup>2</sup>	1120 Wm <sup>2</sup>
<b>Contamination by liquids foreign substances</b>	<b>Max.</b>	<b>Max.</b>	<b>Max.</b>
Sodium chlorid (Saltwater/seawater) (ppm)	0	0,3	0,3
Oil (ppm)	0	5,0	500
Sodium stearate (soap)	none	5% aqueous, not gelatinous	5% aqueous, not gelatinous
Cleaning agents	none	ffs	ffs
Dissolved carriers	none	temporary (condensation)	current
<b>Contamination by gases foreign substances (cm<sup>3</sup>/m<sup>3</sup>=ppm)</b>	<b>Average value/maximum value</b>	<b>Average value/maximum value</b>	<b>Average value/maximum value</b>
Hydrogen sulphide	<0,003/<0,01	<0,05/<0,5	<10/<50
Sulphur dioxide	<0,01/<0,03	<0,1/<0,3	<5/<15
Sulphur trioxide	<0,01/<0,03	<0,1/0,3	<5/<15
Wet chlorine (<50% humidity)	<0,0005/<0,001	<0,005/<0,03	<0,05/<0,3
Dry chlorine (<50% humidity)	<0,002/<0,01	<0,02/<0,1	<0,2/<1,0
Hydrogen chloride	-/<0,06	<0,06/<0,3	<0,6/3,0
Hydrogen fluoride	<0,001/<0,005	<0,01/<0,05	<0,1/<1,0
Ammonia	<1/<5	<10/<50	<50/<250
Nitrogen oxide	<0,05/<0,1	<0,57/<1	<5/<10
Ozone	<0,002/<0,005	<0,025/<0,05	<0,1/<1
<b>Electromagnetic properties</b>	<b>E1</b>	<b>E2</b>	<b>E3</b>
Electromagnetic discharge Contact (0,667µC)	4 kV	4 kV	4 kV
Electromagnetic discharge - Air (0,132µC)	8 kV	8 kV	8 kV
Solar irradiation	700 Wm <sup>2</sup>	1.120 Wm <sup>2</sup>	1.120 Wm <sup>2</sup>
EMC-Emission HF-AM	3 V/m at 80-2.000 MHz 1V/m at 2.000-2.700 MHz	3 V/m at 80-2.000 MHz 1V/m at 2.000-2.700 MHz	10 V/m at 80-1.000 MHz 3V/m at 1.400-2.000 MHz
Conducted HF	3 V at 150 kHz - 80 MHz	3 V at 150 kHz - 80 MHz	10 V at 150 kHz - 80 MHz
EFT/B			
Alternating current	500 V	1.000 V	2.000 V
Volatage surge (earth potential difference)			
Signal, earthing line	500 V	1.000 V	2.000 V
Magnetic field (50/60 Hz)	1 Am <sup>-1</sup>	3 AM <sup>-1</sup>	30 Am <sup>-1</sup>
Magnetic field (60-20.000 Hz)	ffs	ffs	ffs
Surge: Long term effect of repeated surges on the channel must be taken into account			

\* Installation-specific according to IEC 61918 / Draft standard CD ISO/IEC 24702

# ■ THE MICE CONCEPT

## Application Examples

Area of application	properties								environment class
	Humidity	Vibration	Irradiation	Electrical	UV light	Aggressiv Fields	Oil	H <sup>2</sup> O	
									Solution proposals
Chemical industry	x	x		x		x	x	x	M <sub>2</sub> I <sub>3</sub> C <sub>2</sub> E <sub>2</sub>
Car manufacturing		x		x		x	x		M <sub>3</sub> I <sub>3</sub> C <sub>2</sub> E <sub>3</sub>
Airport	x				x		x		M <sub>2</sub> I <sub>2</sub> C <sub>1</sub> E <sub>1</sub>
Transmission line	x				x		x	x	M <sub>2</sub> I <sub>2</sub> C <sub>1</sub> E <sub>1</sub>
Oil production facility	x	x			x		x	x	M <sub>3</sub> I <sub>3</sub> C <sub>2</sub> E <sub>1</sub>
Mining	x	x							M <sub>3</sub> I <sub>3</sub> C <sub>1</sub> E <sub>1</sub>
Power station	x	x	x	x					M <sub>3</sub> I <sub>3</sub> C <sub>2</sub> E <sub>3</sub>
Nuclear power station	x	x	x	x		x	x		M <sub>3</sub> I <sub>3</sub> C <sub>2</sub> E <sub>3</sub>
Steelworks	x	x		x					M <sub>3</sub> I <sub>3</sub> C <sub>2</sub> E <sub>3</sub>

Possible classification criteria of environmental requirements

# ■ IAONA-CLASSIFICATION

General requirements for cabling components in the industrial environment according to IAONA recommendations

Parameter	Value	Notes
Operating temperature	0°C ... +55°C	Installation >5°C
Storage temperature	-25°C ... +70°C	IEC 61131-2
Storage temperature	5°C ... +55°C, 3°C/min. Test N b	IEC 6068-2-14
Humidity	10% ... 95% non-condensing	IEC 60068-2-14
Shock test	15 G, 11 ms according to EN 60068-2-27 or IEC 60068-2-27 Criterion: no mechanical or functional damage	
Vibration	5 G at 10 Hz ... 150 Hz according to EN 60068-2-6 or IEC 60068-2-6, Kriterium A	
Earthing		
Cabling class (min. requirements)	EN 50173; 2002 or ISO/IEC 11801, Klasse D	

**There are also two protection classes defined in addition to these general requirements which, on closer examination, are aimed at the protection of the connection components:**

### Light Duty (IP20)

This class contains components which are installed in a protected distribution cabinet. These requirements must be limited by those for the office environment as these cabinets are also installed in the vicinity of moving system parts. The protection class IP20 according to EN 60529 is defined for this

class which states that the components are protected against penetration by solid foreign substances no larger than 12.5 mm. Protection against penetration by moisture is not included.

### Heavy Duty (IP67)

The components in this protection class are completely exposed to the aggressive industrial environment. According to the IP67 protection class, the components are constructed absolutely dustproof and protected against damage by temporary immersion in water.

	Light Duty	Heavy Duty
Protection class Degree of contamination	IP 20 + IP 30 according to IEC 60529, EN 60529	IP 67 + IP 69 according to IEC 60529, EN 60529
Relative humidity	95% non-condensing	Temperature cycles (25°C-50°C-25°C) at 80% to 95% Relative humidity condensing according to IEC 60068-2-30
Operating temperature	0°C at +55°C	-20°C at +65°C
Shock test	15 G, 11 ms according to EN 60068-2-27 and IEC 60068-2-27 no mechanical and functional damage	15 G, 11 ms according to EN 60068-2-27 and IEC 60068-2-27 no mechanical and functional damage
Vibration	5 G at 10 Hz ... 150 Hz according to EN 60068-2-6 and IEC 60068-2-6, Krit. A	5 G at 10 Hz ... 150 Hz according to EN 60068-2-6 and IEC 60068-2-6, Krit. A

# CHARACTERISTICS\* OF INSULATING AND SHEATH MATERIALS

Designation				Electrical					Thermic			
	VDE Initial Code	Abbreviations	Materials	Density	Break-down-voltage	Spezific volume resistivity	Dielectric constant	Dielectric lossfactor	Working temperature		Meltemperature	Flame resistance
				g/m <sup>3</sup>	KV/mm (20°C)	Ohm·cm 20°C	50 Hz/ 20°C	tan δ	permanent °C	short time °C	+°C	
Thermoplastic	Y	PVC	Polyvinylchloride comounds	1,35-1,5	25	10 <sup>13</sup> -10 <sup>15</sup>	3,6-6	4x10 <sup>-2</sup> - 1x10 <sup>-1</sup>	-30 +70	+100	>140	self-extinguishing
	Yw	PVC	Heat resistant 90°C	1,3-1,5	25	10 <sup>12</sup> -10 <sup>15</sup>	4-6,5		-20 +90	+120	>140	
	Yw	PVC	Heat resistant 105°C	1,3-1,5	25	10 <sup>12</sup> -10 <sup>15</sup>	4,5-6,5		-20 +105	+120	>140	
	Yk	PVC	Cold resistant	1,2-1,4	25	10 <sup>12</sup> -10 <sup>15</sup>	4,5-6,5		-40 +70	+100	>140	
	2Y	LDPE	low density Polyethylene	0,92-0,94	70	10 <sup>17</sup>	2,3	2x10 <sup>-4</sup>	-50 +70	+100	105-110	flammable
	2Y	HDPE	high density Polyethylene	0,94-0,98	85	10 <sup>17</sup>	2,3	3x10 <sup>-4</sup>	-50 +100	+120	130	
	2X	VPE	crossed-linked Polyethylene	0,92	50	10 <sup>12</sup> -10 <sup>16</sup>	4-6	2x10 <sup>-3</sup>	35 +90	+100	-	
	O2Y		foamed Polyethylene	-0,65	30	10 <sup>17</sup>	-1,55	5x10 <sup>-4</sup>	-40 +70	+100	105	
	3Y	PS	Polystrole	1,05	30	10 <sup>16</sup>	2,5	1x10 <sup>-4</sup>	-50 +80	+100	>120	
	4Y	PA	Polyamide	1,02-1,1	30	10 <sup>15</sup>	4	2x10 <sup>-2</sup> - 1x10 <sup>-3</sup>	-60 +105	+125	210	
	9Y	PP	Polypropylene	0,91	75	10 <sup>16</sup>	2,3-2,4	4x10 <sup>-4</sup>	-10 +140	+140	160	
	11Y	PUR	Polyurethane	1,15-1,2	20	10 <sup>10</sup> -10 <sup>12</sup>	4-7	2,3x10 <sup>-2</sup>	-55 +80	+100	150	
	TPE-E (12Y)		Polyester; Elastomer	1,2-1,4	40	>10 <sup>10</sup>	3,7-5,1	1,8x10 <sup>-2</sup>	-50 +100	+140	190	
	TPE-O		Polyolefine; Elastomer	0,89-1,0	30	>10 <sup>14</sup>	2,7-3,6		+130	150		
Elastomere	G	NR/SBR	Natural rubber Styrol-Butadiene-rubber-compunds	1,5-1,7	20	10 <sup>12</sup> -10 <sup>15</sup>	3-5	1,9x10 <sup>-2</sup>	-65 +60	+120	-	flammable
	2G	SiR	Silicon rubber	1,2-1,3	20	10 <sup>15</sup>	3-4	6x10 <sup>-3</sup>	-60 +180	+260	-	high flammable
	3G	EPR	Ethylene-Propylene rubber compunds	1,3-1,55	20	10 <sup>14</sup>	3-3,8	3,4x10 <sup>-3</sup>	-30 +90	+160	-	flammable
	4G	EVA	Ethylene-Vinylacetat Copolymer-compunds	1,3-1,5	30	10 <sup>12</sup>	5-6,5	2x10 <sup>-2</sup>	-30 +125	+200	-	
	5G	CR	Polychloropren compunds	1,4-1,65	20	10 <sup>10</sup>	6-8,5	5x10 <sup>-2</sup>	-40 +100	+140	-	self-extinguishing
	6G	CSM	Chlorsulfonated Polyethylene compunds	1,3-1,6	25	10 <sup>12</sup>	6-9	2,8x10 <sup>-2</sup>	-30 +80	+140	+160	
High temp.materials	10Y	PVDF	Polyvinylidene fluoride Kynar/Dyflor	1,7-1,9	25	10 <sup>14</sup>	9-7	1,4x10 <sup>-2</sup>	-40 +135	+160	>170	self-extinguishing
	7Y	ETFE	Ethylene-tetrafluor ethylene	1,6-1,8	36	10 <sup>16</sup>	2,6	8x10 <sup>-4</sup>	-100 +150	+180	>265	
	6Y	FEP	Fluorine ethylene propylene	2,0-2,3	25	10 <sup>18</sup>	2,1	3x10 <sup>-4</sup>	-100 +205	+230	>225	
	5YX	PFA	Perfluoralkoxyolimeric	2,0-2,3	25	10 <sup>18</sup>	2,1	3x10 <sup>-4</sup>	-190 +260	+280	>290	
	5Y	PTFE	Polytetrafluorethylene	2,0-2,3	20	10 <sup>18</sup>	2,1	3x10 <sup>-4</sup>	-190 +260	+300	>325	
halogen-free compunds	H	uncross-linked	halogen-free Polymer-compunds	1,4-1,6	25	10 <sup>12</sup> -10 <sup>14</sup>	3,4-5	~10 <sup>-1</sup>	-30 +70	+100	>130	self-extinguishing
	HX	cross-linked	halogen-free Polymer-compunds	1,4-1,6	25	10 <sup>13</sup> -10 <sup>14</sup>	3,4-5	10 <sup>-2</sup> - 10 <sup>-1</sup>	-30 +90	+150	-	

\* The characteristics valid for unprocessed materials

Thermic					Mechanical						Halogen-free	Weather						
Oxygen index LOI (% O <sub>2</sub> )	Heating value H <sub>0</sub> MU kg <sup>-1</sup>	Thermal-conductivity W K <sup>-1</sup> m <sup>-1</sup>	Corrosive gases in case of fire	Radiation resistance max. Mrad	tensile strength N/mm <sup>2</sup>	Elongation at break %	Shorehardness	Abrasion resistance	Abrasion resistance	halogenfree	Weather resistance	Cold resistance						
23-42	17-25	0,17	Hydrogen chlorid	80	10-25	130-350	70-95 (A)	medium	0,4	no	medium in black	moderate good						
	16-22																	
	24-42												16-20					
	17-24																	
≤22	42-44	0,3	no	100	10-20	400-600	43-50 (D)	medium good	0,1	yes	-	good						
		0,4			20-30	500-1000	60-63 (D)						good					
		0,3			12,5-20	300-400	40-45 (D)	medium good										
		0,25			8-12	350-450	-	-	-	conditional <sup>1)</sup>	good							
	18-30	40-43			0,25	80	55-65	300-400	35-50 (D)	good	0,4	yes	-	-	good			
					0,23		10	50-60	50-170	-	very good					1,0-1,5	moderate good	moderate good
					0,19			20-35	300	55-60 (D)	medium good					0,1	good	good
	20-26	20-26			0,25	100 (500)	30-45	500-700	70-100(A)	very good	1,5	yes <sup>2)</sup>	medium	good				
	≤29	20-25			0,5	10	30	>300	85 (A) 70 (D)	good		yes	very good	very good				
	≤25	23-28			1,5		20		55 (A) 70 (D)		very good							
≤22	21-25	-	no	100	5-10	300-600	60-70 (A)	moderate	1,0	no	medium	very good						
25-35	17-19	0,22					40-80 (A)				yes		good					
							200-400						65-85 (A)	very good				
≤22	21-25	-					100				8-12		25-350	70-80 (A)	gut	good		
30-35	14-19	-	Hydrogen chlorid	50	10-20	400-700	55-70 (A)	moderate	1,5	no	very good	moderate good						
	19-23	-				35-600	60-70 (A)				medium							
40-45	15	0,17	Hydrofluoric	10	50-80	150	75-80 (D)	very good	no	very good	very good	very good						
	30-35	14			0,24	40-50	150						70-75 (D)					
						1	15-25						250	55-60 (D)				
	>95	5			0,26	yes	0,1								25-30	50		
0,21			80															
≤40	17-22	0,17	no	100	8-13	150-250	65-95 (A)	moderate	0,2-1,5	yes	medium in black: good	medium						
	16-25	0,20		200	8-13	150-250												

# ■ ESSENTIAL CABLE PARAMETERS

## Wave impedance

Characteristic impedance is the terminating resistance of a cable at which no line reflections occur, i.e. the total power fed into the cable by a signal source is transmitted at the characteristic impedance on the output, except for the losses caused by cable attenuation. A data cable's task is transmitting electrical pulse groups. The higher the desired data bit rate, the greater the frequency bandwidth that must be selected for the transmission channel (e.g. cable). Output impedance and input impedance of the devices connected to the cable must match (or must be adapted) to the characteristic impedance of the data cable. If this is not the case, then pulse distortions occur, which means defective transmission. The characteristic impedances of symmetric cables for telecommunications engineering are standardised in EN 50173 or ISO/IEC 11801: 100, 120 and 150.

## Wave attenuation $\alpha$ [dB]

Cable attenuation reduces the signal amplitude arriving at the output, and thus limits the free cable lengths that can be implemented. Ohmic loss resistance in the longitudinal direction occurs due to the conductor material and the conductor cross section. In addition the skin effect (current displacement) reduces the effective conductor cross section as frequency increases. The frequency dependence of the selected core insulation material also determines additional capacitive loss resistances between the conductors. Cable attenuation, which is usually specified at a reference length of 100 m, defines the ratio of transmission level to reception level.

## Near-end crosstalk NEXT, $\alpha_{NN}$ [dB]

Cross-talk describes the undesired passover of signal energy into a neighbouring line channel. In this process, the electromagnetic field of the wanted signal of a conductor pair generates an interference signal on the same cable side (NEAR-END) in a neighbouring core pair. Near-end crosstalk (NEXT) results from the power ratio "Input power on the interfering pair to output power on the disturbed pair", but at the same end of the cable.

## Far-end crosstalk FEXT, $\alpha_{FN}$ [dB]

The electromagnetic field of the wanted signal at the input of the pair generates an interference signal at the output side (FAR-END) of a neighbouring pair. Far end crosstalk (FEXT) results from the power ratio "Input power on the interfering core pair to output power on the disturbed pair", but at the opposite end of the cable.

## ELFEXT

ELFEXT is a relative value that defines the ratio of the crosstalk output level to the actual output level. The interference level interspersed on the second pair is placed in the ratio to the output level. The ELFEXT value has the advantage relative to the FEXT value that it is not dependent on channel length, because the interference signal as well as the output signal depend on the channel length, and are determined on the same remote point.

## Attenuation to Crosstalk Ratio - ACR [dB]

The ACR value is determined by the difference of near-end crosstalk and line attenuation, measured at the same frequency.

## ACR(f) NEXT(f) - $\alpha$ (f)

Thus, in order to ensure problem-free transmission, the ACR must be as high as possible (high NEXT and low wave attenuation). The ACR value is a characteristic value used for simple evaluation of a cable's transmission quality. For cables, the ACR should be at least 10dB at the highest signal transmission frequency.

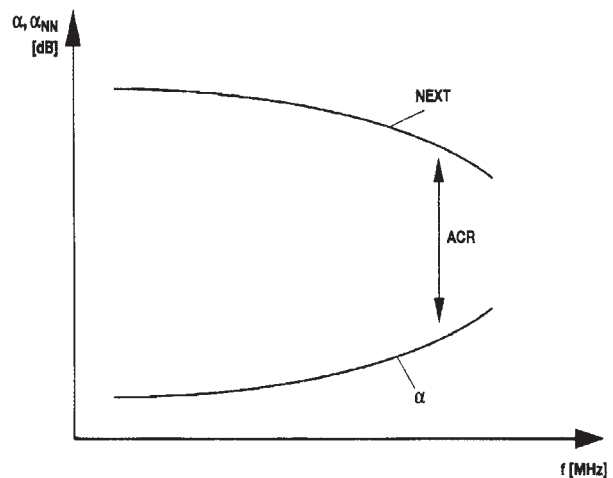

## Power Sum NEXT [dB]

Crosstalk is the signal portion induced in one line channel from a neighbouring line channel. The power sum is calculated from the addition of the crosstalk values of all elements contained in the cable.



# ■ ESSENTIAL CABLE PARAMETERS

## PSACR

Power Sum ACR defines the sum of all ACRs detected for the individual pairs (difference NEXT to attenuation).

## PSELFEXT

The power sum FEXT comprises the powersum of the far-end crosstalk. This is the sum of all interference signals that are coupled in a pair. For 2 pair cable the PSFEXT corresponds to the FEXT; if the number of conductor pairs is higher, then the differences become ever greater because the interference signals from all pairs are interspersed in one pair.

## Return loss attenuation [dB]

If there are different wave resistances (e.g. between cable and a component), then a portion of the supplied signal energy is reflected at this interference point. Such reflections must be kept to a minimum to ensure problem-free transmission.

## Delay Skew

This refers to the runtime differences of the individual pairs.

## Transfer impedance $R_k$ [ $\Omega/m$ ]

As the transmission frequency for data lines increases, electromagnetic compatibility (EMC) becomes increasingly more important. To protect the cables from the effects of unwanted interference or to protect any surrounding electrical systems from disruptive emanations from the cable, more attention is being paid to adequate shielding for data transmission lines.

The magnetic field of a pair of conductors can largely be compensated for by twisting the wires, but the electrical field has to be countered by attaching sheet shielding and/or braided shielding. The transfer impedance (coupling resistance) is frequency-dependent and increases with the length of the cable (linear). The coupling resistance is therefore specified in

$\Omega/m$  and should be as low as possible. The lower the coupling resistance, the more efficient the shielding effect and the more significantly it contributes toward optimizing the EMC values of the entire system. Another important factor for the shielding effect is the choice and quality of the grounding point, which should have as low a resistance value as possible over the entire frequency range. By using double shielding (sheet and braided shielding), a vastly improved shielding effect can be obtained, particularly in the higher frequency range.

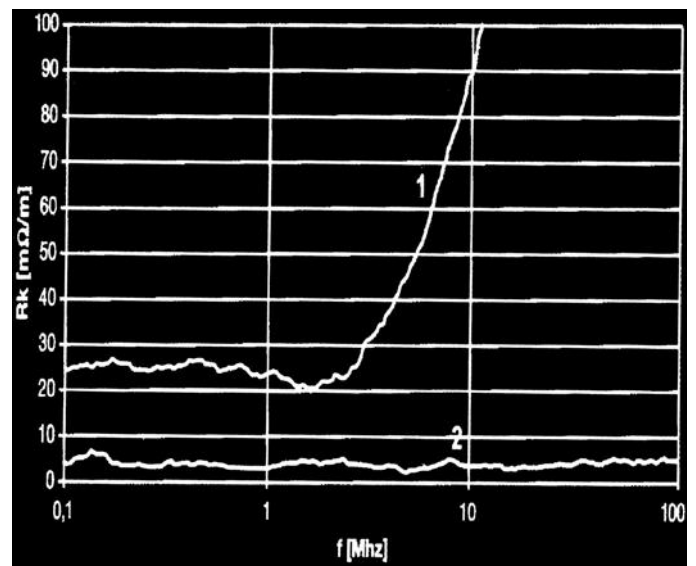

1 ... Sheet shielding  
2 ... FSheet and braided shielding

# EN (EUROPEAN) STANDARDS

## EN 50173 Channel Class C / Cat. 3, low-frequency (phone, DSL)

Wire Map	Resolution $\Omega$	Length Max.	Prop. Delay nS	Delay Skew nS	Freq. MHz	Insertion Loss dB	NEXT dB	RL dB	ACR-N dB	ACR-F dB	PS NEXT dB	PS ACR-N dB	PS ACR-F dB
12345678	40	i	555	50	1	4,2	39,1	15,0	34,9				
12345678					4	7,6	29,2	15,0	21,6				
					8	10,4	24,3	15,0	13,9				
12345678S					10	11,5	22,7	15,0	11,2				
12345678S					16	14,4	19,4	15,0	5,0				

## EN 50173 Channel Class D / Cat. 5, Ethernet to 100 MBit/s (4-pairs)

Wire Map	Resolution $\Omega$	Length Max.	Prop. Delay nS	Delay Skew nS	Freq. MHz	Insertion Loss dB	NEXT dB	RL dB	ACR-N dB	ACR-F dB	PS NEXT dB	PS ACR-N dB	PS ACR-F dB
12345678	25	i	555	50	1	4,2	60,0	17,0	56,0	57,4	57,0	53,0	54,4
12345678					4	4,5	53,5	17,0	49,0	45,4	50,5	46,0	42,4
					8	6,4	48,6	17,0	42,2	39,3	45,6	39,2	36,3
12345678S					10	7,2	47,0	17,0	39,8	37,4	44,0	36,8	34,4
12345678S					16	9,1	43,6	17,0	34,5	33,3	40,6	31,5	30,3
					20	10,2	42,0	17,0	31,8	31,4	39,0	28,8	28,4
					25	11,5	40,3	16,0	28,9	29,4	37,3	25,9	26,4
					31,25	12,9	38,7	15,1	25,8	27,5	35,7	22,8	24,5
					62,5	18,6	33,6	12,0	15,0	21,5	30,6	12,0	18,5
					100	24,0	30,1	10,0	6,1	17,4	27,1	3,1	14,4

## EN 50173 Channel Class E / Cat. 6, Ethernet 200 MBit/s (4-pair), up to 1000 MBit/s

Wire Map	Resolution $\Omega$	Length Max.	Prop. Delay nS	Delay Skew nS	Freq. MHz	Insertion Loss dB	NEXT dB	RL dB	ACR-N dB	ACR-F dB	PS NEXT dB	PS ACR-N dB	PS ACR-F dB
12345678	25	i	555	50	1	4,0	65,0	19,0	61,0	63,3	62,0	58,0	60,3
12345678					4	4,2	63,0	19,0	58,9	51,2	60,5	56,4	48,2
					8	5,9	58,2	19,0	52,3	45,2	55,6	49,7	42,2
12345678S					10	6,6	56,6	19,0	50,0	43,3	54,0	47,4	40,3
12345678S					16	8,3	53,2	18,0	44,9	39,2	50,6	42,3	36,2
					20	9,3	51,6	17,5	42,3	37,2	49,0	39,7	34,2
					25	10,5	50,0	17,0	39,6	35,3	47,3	36,9	32,3
					31,25	11,7	48,4	16,5	36,7	33,4	45,7	34,0	30,4
					62,5	16,9	43,4	14,0	26,5	27,3	40,6	23,7	24,3
					100	21,7	39,9	12,0	18,2	23,3	37,1	15,4	20,3
					200	31,7	34,8	9,0	3,1	17,2	31,9	0,1	14,2
					250	35,9	33,1	8,0	-2,8	15,3	30,2	-5,8	12,3

## EN 50173 Channel Class EA / Cat. 6A, Ethernet up to 10 Gbit/s, short-length

Wire Map	Resolution $\Omega$	Length Max.	Prop. Delay nS	Delay Skew nS	Freq. MHz	Insertion Loss dB	NEXT dB	RL dB	ACR-N dB	ACR-F dB	PS NEXT dB	PS ACR-N dB	PS ACR-F dB
12345678	25	i	555	50	1	4,0	65,0	19,0	61,0	63,3	62,0	58,0	60,3
12345678					4	4,2	63,0	19,0	58,9	51,2	60,5	56,4	48,2
					8	5,8	58,2	19,0	52,4	45,2	55,6	49,8	42,2
12345678S					10	6,5	56,6	19,0	50,1	43,3	54,0	47,5	40,3
12345678S					16	8,2	53,2	18,0	45,0	39,2	50,6	42,4	36,2
					20	9,2	51,6	17,5	42,5	37,2	49,0	39,8	34,2
					25	10,2	50,0	17,0	39,8	35,3	47,3	37,1	32,3
					31,25	11,5	48,4	16,5	36,9	33,4	45,7	34,2	30,4
					62,5	16,4	43,4	14,0	27,0	27,3	40,6	24,2	24,3
					100	20,9	39,9	12,0	19,0	23,3	37,1	16,2	20,3
					200	30,1	34,8	9,0	4,7	17,2	31,9	1,8	14,2
					250	33,9	33,1	8,0	-0,8	15,3	30,2	-3,7	12,3
					350	40,6	30,6	6,6	-10,0	12,4	27,6	-13,0	9,4
					500	49,3	27,9	6,0	-21,4	9,3	24,8	-24,5	6,3

## ■ EN (EUROPEAN) STANDARDS

EN 50173 Channel Class F / Cat. 7, Ethernet up to 1000 Mbit/s, Ethernet up to 10 Gbit/s, short length													
Wire Map	Resolution $\Omega$	Length Max.	Prop. Delay nS	Delay Skew nS	Freq. MHz	Insertion Loss dB	NEXT dB	RL dB	ACR-N dB	ACR-F dB	PS NEXT dB	PS ACR-N dB	PS ACR-F dB
12345678	25	i	555	30	1	4,0	65,0	19,0	61,0	65,0	62,0	58,0	62,0
12345678					4	4,1	65,0	19,0	60,9	65,0	62,0	57,9	62,0
					8	5,7	65,0	19,0	59,3	62,4	62,0	56,3	59,4
12345678S					10	6,4	65,0	19,0	58,6	60,8	62,0	55,6	57,8
12345678S					16	8,1	65,0	18,0	56,9	57,5	62,0	53,9	54,5
					20	9,1	65,0	17,5	55,9	55,9	62,0	52,9	52,9
					25	10,2	65,0	17,0	54,8	54,4	62,0	51,8	51,4
					31,25	11,4	65,0	16,5	53,6	52,8	62,0	50,6	49,8
					62,5	16,3	65,0	14,0	48,7	47,8	62,0	45,7	44,8
					100	20,8	62,9	12,0	42,1	44,4	59,9	39,1	41,4
					200	30,0	58,3	9,0	28,4	39,4	55,3	25,4	36,4
					250	33,8	56,9	8,0	23,1	37,8	53,9	20,1	34,8
					600	54,6	51,2	8,0	-3,4	31,3	48,2	-6,4	28,3

EN 50173 Channel Class FA / Cat. 7A, Ethernet up to 10 Gbit/s (IEEE 802.3an)

Wire Map	Resolution $\Omega$	Length Max.	Prop. Delay nS	Delay Skew nS	Freq. MHz	Insertion Loss dB	NEXT dB	RL dB	ACR-N dB	ACR-F dB	PS NEXT dB	PS ACR-N dB	PS ACR-F dB
12345678	25	i	555	30	1	4,0	65,0	19,0	61,0	65,0	62,0	58,0	62,0
12345678					4	4,1	65,0	19,0	60,9	65,0	62,0	57,9	62,0
					8	5,7	65,0	19,0	59,3	65,0	62,0	56,3	62,0
12345678S					10	6,4	65,0	19,0	58,6	65,0	62,0	55,6	62,0
12345678S					16	8	65,0	18,0	57,0	63,3	62,0	54,0	60,3
					20	9	65,0	17,5	56,0	61,4	62,0	53,0	58,4
					25	10	65,0	17,0	55,0	59,4	62,0	52,0	56,4
					31,25	11,2	65,0	16,5	53,8	57,5	62,0	50,8	54,5
					62,5	15,9	65,0	14,0	49,1	51,5	62,0	46,1	48,5
					100	20,3	65,0	12,0	44,7	47,4	62,0	41,7	44,4
					200	28,9	60,9	9,0	32,0	41,4	57,9	29,0	38,4
					250	32,5	59,1	8,0	26,7	39,4	56,1	23,7	36,4
					600	51,4	51,2	8,0	0,7	31,8	49,1	-2,3	28,8

(STAND 07/2010)

# ■ CLASSIFICATION OF FIBRE OPTIC CABLES / TRANSMISSION RANGES

Transmission distance according to ISO/IEC 11801 (2<sup>nd</sup> Edition) bzw. EN 50173

Attenuation of the transmission distance

Class	Attenuation [dB]			
	Multimode LWL ; 50 µm und 62,5 µm		Singlemode LWL	
	850 nm	1300 nm	1310 nm	1550 nm
OF 300	2,55	1,95	1,80	1,80
OF 500	3,25	2,25	2,00	2,00
OF 2000	8,50	4,50	3,50	3,50

OF ... = Optical Fiber mit Übertragungsstrecke in m.

Specification for 10 Mbit/s bis 1 Gbit/s

Application	Fibre type							
	OM 1		OM 2		OM 3		OS 1	
	850 nm	1300 nm	850 nm	11300 nm	850 nm	1300 nm	1310 nm	1550 nm
FOIRL	OF 2000		OF 2000		OF 2000			
10 BASE-FL, FP und -FB	OF 2000		OF 2000		OF 2000			
100 BASE-FX		OF 2000		OF 2000		OF 2000		
1000 BASE-SX	OF 300		OF 500		OF 500			
1000 BASE-LX		OF 500		OF 500		OF 500	OF 2000	

Specification for 10 Gbit/s

Application	Fibre type							
	OM 1		OM 2		OM 3		OS 1	
	850 nm	1300 nm	850 nm	11300 nm	850 nm	1300 nm	1310 nm	1550 nm
10 BASE-LX4		OF 300		OF 300				
10 BASE-ER/EW								OF 2000
10 BASE-SR/SW					OF 300			
10 BASE-LR/LW							OF 2000	

Ranges for 10/100/1000/10000 Mbit/s-Ethernet

	Medium	Cable	Range <sup>1)</sup>
<b>Ethernet</b>	AUI		50 m
	10BASE2	Thin Ethernet	185 m
	10BASE5	Thin Ethernet	500 m
	10BASE-T	Twisted Pair	100 m
	10BASE-FL	62,5 µm, 50µm Multimode-LWL	2.000 m
<b>Fast Ethernet</b>	100BASE-TX	Twisted Pair	100 m
	100BASE-FX	62,5 µm, 50µm Multimode-LWL HDX	412 m
		62,5 µm, 50µm Multimode-LWL FDX	2.000 m
<b>Gigabit Ethernet</b>	1000BASE-CX	Koax	25 m
	1000BASE-T	Twisted Pair, Cat. 5	100 m
	1000BASE-SX	62,5 µm Multimode LWL	275 m
		50 µm Multimode LWL	550 m
	1000BASE-LX	62,5 µm Multimode LWL	550 m
		50 µm Multimode LWL	550 m
		9 µm Singlemode LWL	5.000 m
<b>10 Gigabit</b>	10GBASE-LX4	Multimode LWL	300 m
<b>Ethernet</b>	10GBASE-SR/SW	Multimode LWL	66 m
	10GBASE-LR/LW	Singlemode LWL	10.000 m
	10GBASE-ER/EW	Singlemode LWL	40.000 m

<sup>1)</sup>minimum supported value

# FIBRESPECIFICATIONS

<b>Graded index fibres (multimode)</b>			
<b>Specification</b>		<b>Fibre type G 50/125</b>	<b>Fibre type G 62,5/125</b>
Fibre categorie		OM2 Standardfibre	OM1 Standardfibre
Core diameter		50 ± 3 µm	62,5 ± 3 µm
Numerical aperture		0,200 ± 0,015	0,275 ± 0,015
Typ. attenuation	850 nm	2,5 dB/km	3,0 dB/km
	1300 nm	0,7 dB/km	1,0 dB/km
Min. bandwidth	850 nm	500 MHz x km	200 MHz x km
	1300 nm	500 MHz x km	500 MHz x km
Cladding diameter		125 ± 1 µm	
Primary coating diameter		245 ± 10 µm	
Core noncircularity		< 5 %	
Cladding concentricity error		< 3,0 µm	
Cladding nonconcentricity		< 2,0 %	
<b>Specification</b>		<b>Fibre type G 50/125</b>	
Fibre categorie		OM3 Standardfibre	OM4 Standardfibre
Core diameter		50 ± 3 µm	50 ± 3 µm
Numerical aperture		0,200 ± 0,015	0,200 ± 0,015
Typ. attenuation	850 nm	2,5 dB/km	3,0 dB/km
	1300 nm	0,5 dB/km	1,0 dB/km
Min. bandwidth	850 nm	1500 MHz x km	3500 MHz x km
	1300 nm	500 MHz x km	500 MHz x km
Cladding diameter		125 ± 1 µm	125 ± 1 µm
Primary coating diameter		245 ± 10 µm	245 ± 10 µm
Core noncircularity		< 5 %	< 5 %
Cladding concentricity error		< 3,0 µm	< 6,0 µm
Cladding nonconcentricity		< 2,0 %	< 2,0 %

<b>Single-mode-fibres</b>			
<b>Specification</b>		<b>Fibre type E9...10/125 (single mode)</b>	
Fibre categorie		ITU-T G. 652.d	ITU-T G 657.A1
Core diameter	1310 nm	0,36 dB/km	0,34 dB/km
Numerical aperture	1550 nm	0,22 dB/km	0,20 dB/km
Typ. attenuation	1285 - 1330 nm	< 3,5 ps/(nm x km)	
	1550 nm	< 19 ps/(nm x km)	< 17,5 ps/(nm x km)
Min. bandwidth		1312 nm	
		9,3 ± 0,5 µm	9,2 ± 0,3 µm
Cladding diameter		125 ± 1 µm	125 ± 1 µm
Primary coating diameter		245 ± 10 µm	245 ± 10 µm
Core noncircularity		< 1250 nm	< 126 nm
Cladding concentricity error		≤ 0,8 µm	≤ 0,5 µm
Cladding nonconcentricity		< 1,0 %	< 0,8 %

<b>POF and HCS Fibre</b>			
<b>Specification</b>		<b>Fibre type POF P980/ 1000</b>	<b>Fibre type HCS K200/230</b>
Core diameter		980 µm	200 µm
Numerical aperture		0,5	0,37
Typ. attenuation	650nm	160 dB/km	10 db/km
	850nm	-	8 dB/km
Min. bandwidth	650nm	10 MHz x 100m	17 MHz x km
	850nm	-	20 MHz x km
Wallthickness		1000 µm	230 µm

Fibres with other parameters on request

# ■ NETWORKS AND FIELD BUSES

## Ethernet



## Profibus



<b>Topology</b>	Star topology where star points are made via active equipment (hub or switch)	Profibus-DP is designed as point-to-point topology. The bus is terminated at both ends with a resistance network connected to the power supply.
<b>Electrical interface, Data transmission</b>	Symmetrical interface, full duplex. Galvanic Decoupling via carrier.	based on symmetrical interface RS 485
<b>Data transfer rate</b>	10/100/1000/10.000 Mbit/s	9,6 Kbit/s - 12 Mbit/s
<b>Electrical interface, Energy transfer</b>	RJ 45, 8-pin PoE+, 8023at, 802.3af	RS 485
<b>Signal designation, Core assignment</b>	Transmit + orange Transmit - white/orange Receive + green Receive - green/white	A-line green B-line red
<b>Plug connector for IP20 or higher</b>	RJ 45 for Light-Duty	D-SUB 9, M12
<b>Plug connector for IP67 or higher</b>	RJ 45 for Heavy-Duty M12, 4-pole, D-coded	D-SUB 9, M12, 5-pole, B-coded
<b>Pin assignment</b>		

Signal designation \ Plug connector	Plug connector	
	RJ 45	M12
Transmit +	2	1
Transmit -	1	3
Receive +	6	2
Receive -	3	4

Signal designation \ Plug connector	Plug connector	
	D-SUB 9	M12
A-line	8	2
B-line	3	4
shield	1	5

<b>Bus length</b>	up to 100m from the Hub/switch to the terminal device	up to 1200m per Segment
<b>Number of participants</b>	unlimited	up to 126, bis 32 per Bus segment
<b>Directive</b>	Industrial Ethernet Planning, EN 50173 and Installation Guide, PNO (Profinet)	Guideline 2.142, PNO
<b>Standardisation</b>	IEE 802.3	EN 50170

## CAN



CAN is designed as point-to-point topology. The bus is terminated at both ends with a terminating resistor

Symmetrical interface, with special definition using CAN transceiver chips

up to 1Mbit/s

not in the standard configuration

CAN\_L green  
CAN\_H yellow  
CAN\_GND brown

COMBICON  
D-SUB 9  
RJ 45

M12, 5-pole, A-coded  
7/8", 5-pole

Signal designation	Plug connector				
	COMBICON	D-SUB 9	M12	RJ 45	7/8"
CAN_L	2	2	5	2	5
CAN_H	4	7	4	1	4
CAN_GND	1	3	3	3	3

up to 1000m

up to 640

CiA DR-303-1

not specified

## Interbus



The Interbus is designed as an active ring. In order to overcome the disadvantage of doubled cable layout, the outgoing and return signals are included in one cable so that the user has the impression of a point-to-point topology.

based on symmetrical S 485 interface

500 kBit/s or 2 Mbit/s

not in the standard configuration

DO yellow  
DO green  
DI grey  
DI pink  
COM brown

D-SUB 9

D-SUB 9  
M12, 5-pole, B-coded

Signal designation	Plug connector	
	D-SUB 9	M12
DO	1	1
DO	6	2
DI	2	3
DI	7	4
COM	3	5

up to 400m between two participants, up to 13 km total length

up to 4096

INTERBUS-conformity test

IEC 61158

## Device Net



Like CAN, another power supply is also transmitted. The series line is called the "trunk line" and the stubs are called "drop lines". The "thick cable" is used for the trunk line and "thin cable" is used for the drop or trunk line.

Symmetrical interface with special definition using CAN transceiver chips

up to 500 KBits/s

24 V DC  
8 A for thick cable  
3 A for thin cable

CAN\_L blue  
CAN\_H white  
V- red  
V+ black  
Drain colourless

COMBICON

M12, 5-pole, A-coded  
7/8", 5-pole

Signal designation	Plug connector		
	COMBICON	M12	7/8"
CAN_L	2	5	5
CAN_H	4	4	4
V+	5	2	2
V-	1	3	3
Drain	3	1	1

up to 500m

up to 2048

DeviceNet Connector Profiles

not specified

■ FIBRE-OPTIC CABLES-CODE ACC. TO DIN VDE 0888

□	—	□	□	□	□	□	□	□	□	□	□	□	□	□
1		2	3	4	5	6	7	8	9	10	11	12	13	14
														Lg layerstranding
														Bandwidth in MHz x km (GF) dispersion parameter in $\frac{\text{ps}}{\text{nm} \times \text{km}}$
														Wavelength B $\hat{=}$ 850 nm F $\hat{=}$ 1300 nm H $\hat{=}$ 1550 nm
														Attenuation coefficient in dB/km
														Cladding diameter in $\mu\text{m}$
														Core diameter in $\mu\text{m}$ of graded index fibre Field diameter in $\mu\text{m}$ of single mode fibre
														Design E Single mode fibre G Graded index fibre
														Number of fibres Number of fibres per buffer Number of multifibres buffer
														Y PVC-sheath H Sheath with halogenfree material B Armouring BY Armouring with PVC-protective covering sheath B2Y Armouring mit PE-protective covering sheath
														Y PVC-sheath 2Y PE-sheath 4Y PA-sheath 11Y PUR-sheath (L)2Y PE-Laminated sheath (ZN)2Y PE-sheath with nonmetallic strength member (L)(ZN)2Y PE-Laminated sheath with nonmetallic strength member
														F Filling of the cable core with petroleum jelly Q Swellingmaterial
														S Metallic element in the cable core
														V Tight buffer K Composite buffer fibre H Loose buffer nonfilled W Loose buffer, filled B Multifibre buffer nonfilled D Multifibre buffer filled
														I Indoor cable A Outdoor cable AT Outdoor fan out cable



# CROSS-SECTIONS OF FIBRE OPTICS AND CORES

## Graded index fibre G 50/125

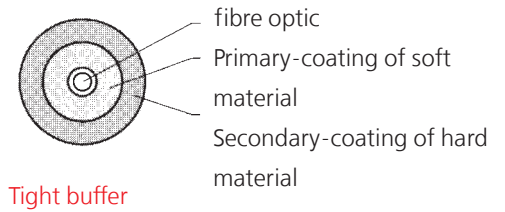
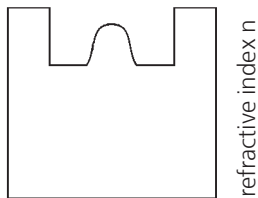
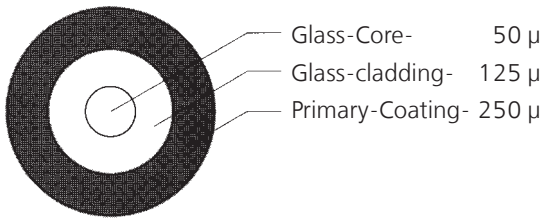

Tight buffer

## Graded index fibre G 62,5/125

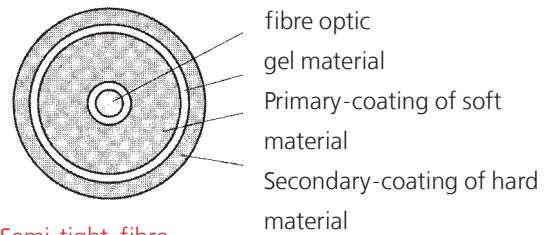
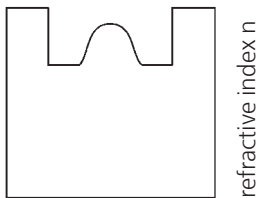
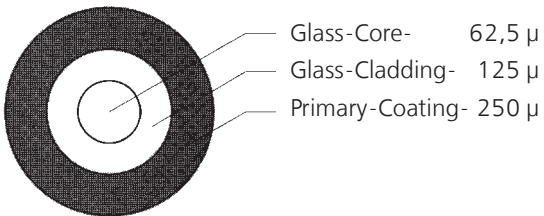

Semi-tight-fibre

## Single-mode fibre E . . 10/125

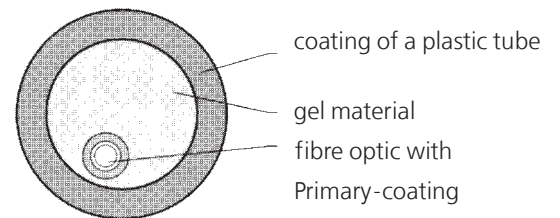
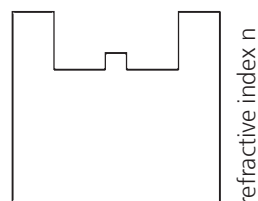
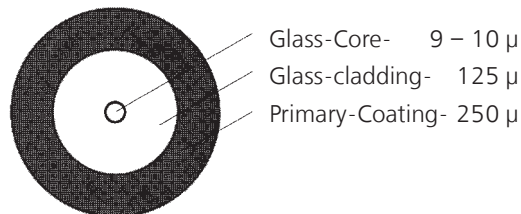

Loose buffer filled

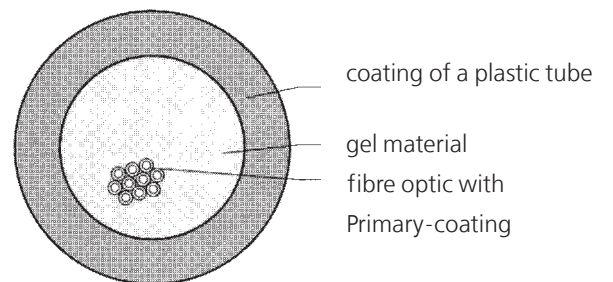

Multifibre buffer filled

# SPECTRAL ATTENUATION CHARACTERISTIC OF GLASS

Attenuation (db/km)

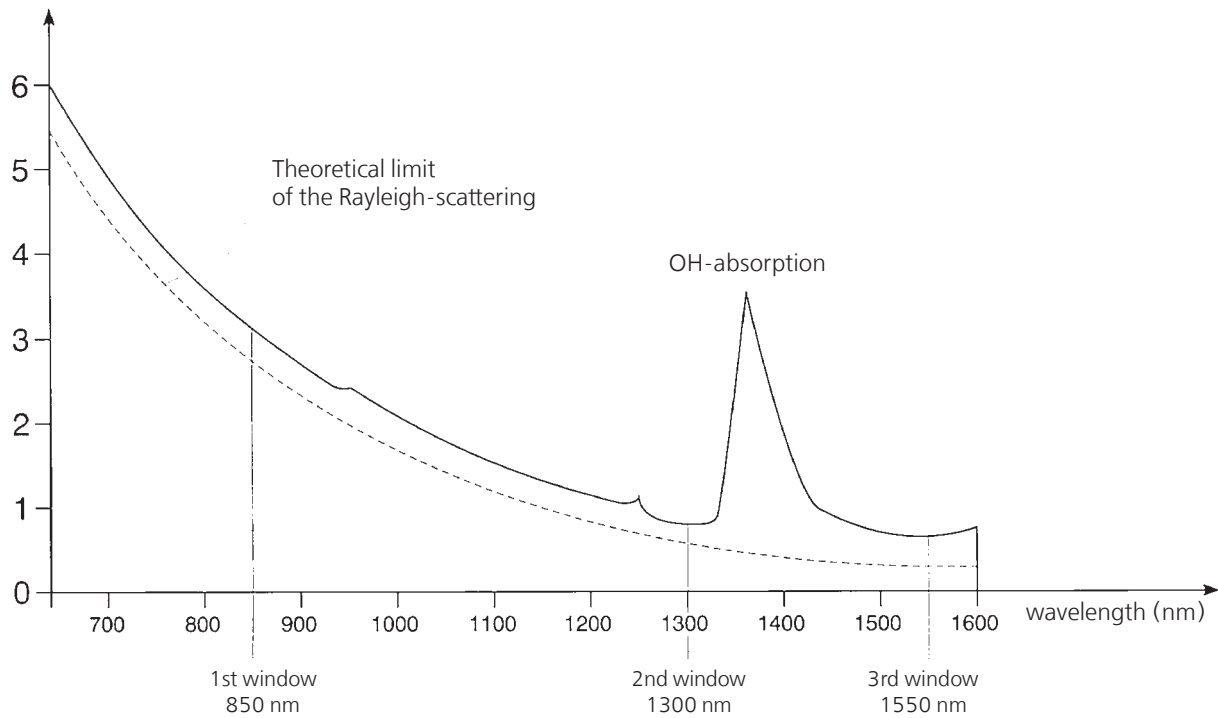

Rayleigh-scattering means the losses that result from the continuous dispersion of light. This continuous dispersion originates in a local change of the refractive index. The refractive index is changed by irregularities of the density of fused silica glass. The Rayleigh-scattering decreases with the increasing of wavelength. Entering of moisture produces OH-ions which cause limited but very high peaks of attenuation at ca. 950, 1200 and 1400 nm.

## Index profiles and characteristics

Fibre-cross-section

Profile of refractive index

Wave propagation (modes) and change of pulse

Characteristics

Step index

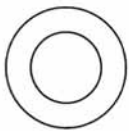

Multimode fibre Input pulse

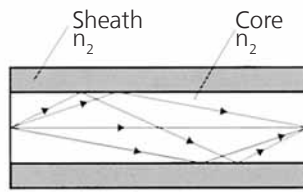
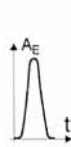
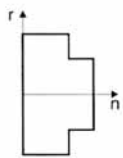

Output pulse

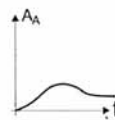

- Bandwidth < 100 MHz / km
- Dispersion 10...150 ns / km
- Long impulse spreading for short distances < 500 m
- Attenuation: middle-high

Graded index

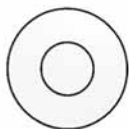

Multimode fibre

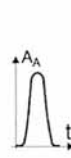
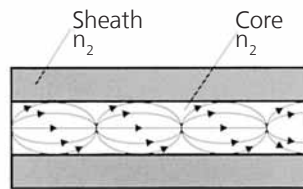
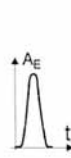
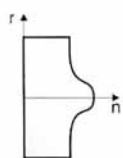

- Bandwidth < 1 GHz / km
- Dispersion 1...5 ns / km
- Short impulse spreading for middle distances > 500 m
- Attenuation: low

Step index



Single mode fibre

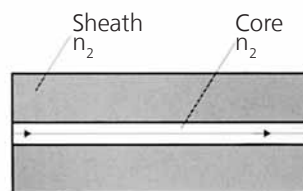
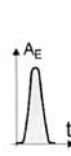
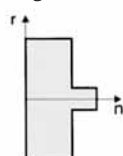

- Bandwidth < 10 GHz / km
- Dispersion 4...150 ns / km
- No impulse spreading for long distances > 500 m
- Attenuation: very low

# THE ELECTROMAGNETIC SPECTRUM

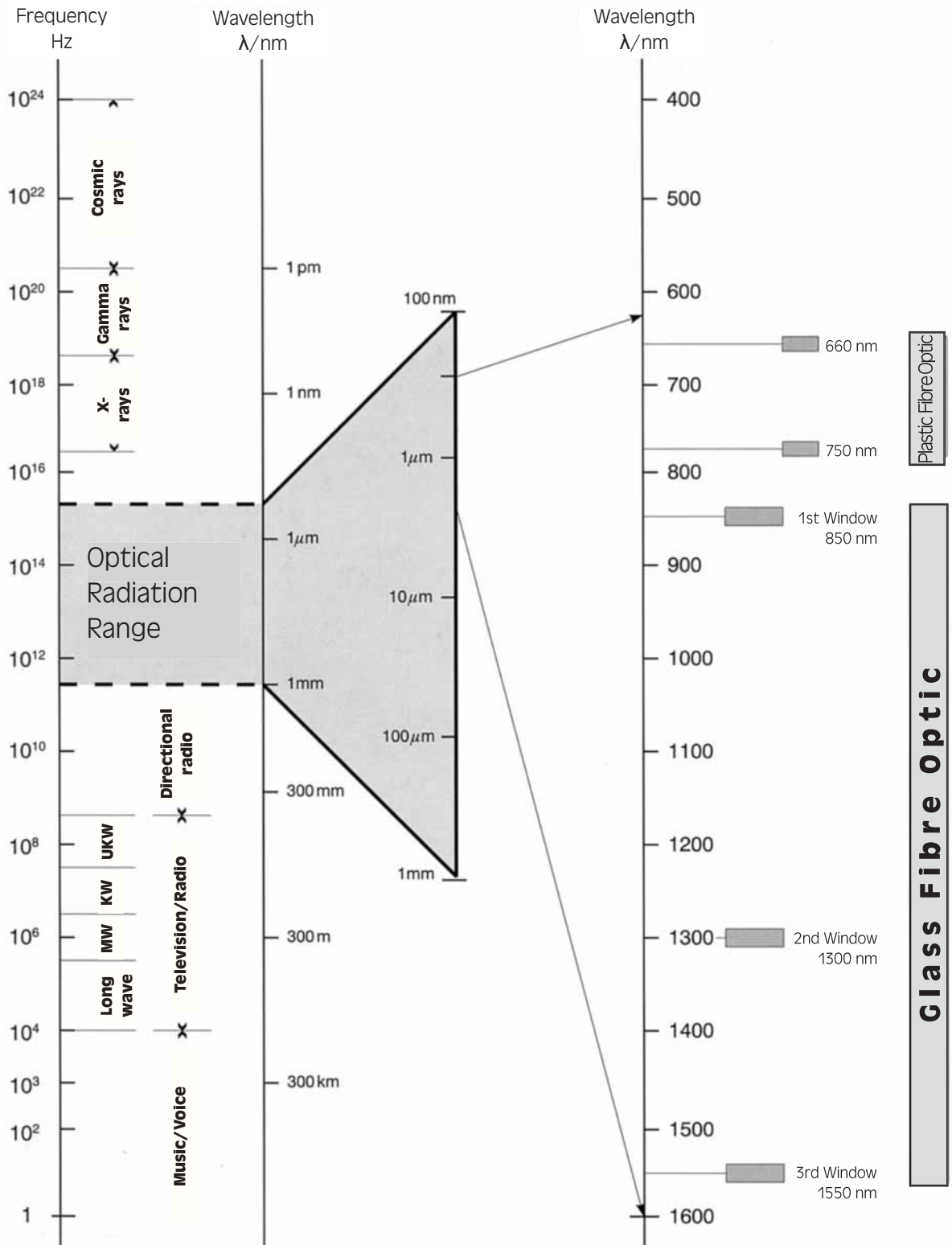

## Visible rays, light

- violett 380 - 420 nm
- blue 420 - 490 nm
- green 530 - 650 nm
- red 650 - 780 nm

## Infra-red ray

780 nm - 1 mm

# ■ FIBRE OPTIC DRAWING TOWER-DESIGN

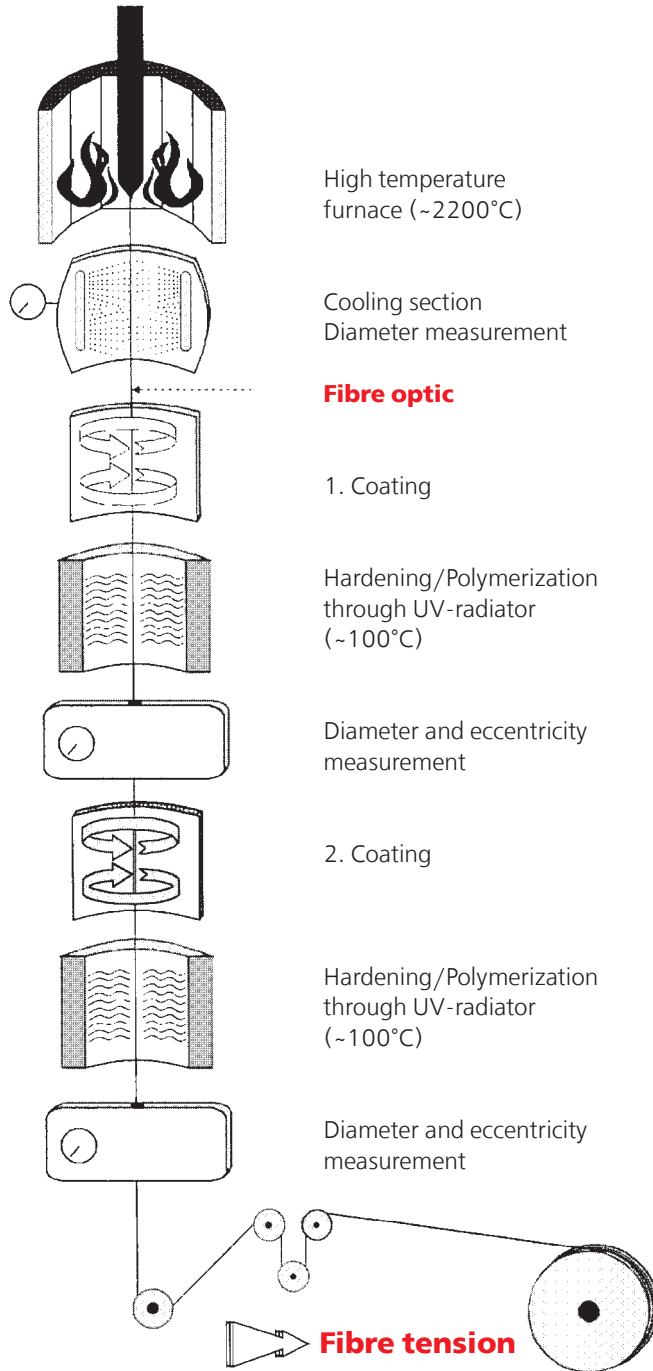

## Faser mit Kunststoffbeschichtung

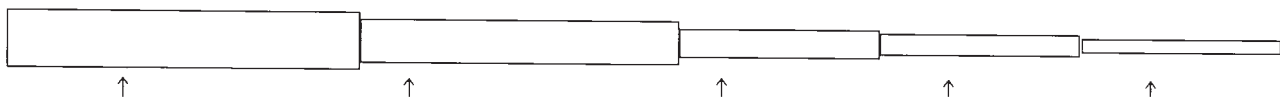

Secondary coating  
(main coating)  
hard material of plastic

Primary coating  
(pre-coating)  
soft material of plastic

Coat of lacquer  
UV-Epoxy

glass cladding ( $n_2$ )

glass core ( $n_1$ )

### Diameter range and coating thickness:

- glass core diameter - 10 to 100  $\mu\text{m}$
- glass cladding diameter - 125 to 150  $\mu\text{m}$
- thickness of lacquer coating - 2 to 5  $\mu\text{m}$
- primary coating diameter - 150 to 500  $\mu\text{m}$
- secondary coating diameter - 250 or 900  $\mu\text{m}$

# CODE-DESIGNATION-EXPLANATIONS FOR CABLES AND INSULATED WIRE

A-	Outdoor cable	(H...) maximal value of mutual capacitance (nF / km)	T-	fan out cable
A	approved national design	(HS) semi-conducting tape of layer	TF	carrier frequency of pairs or quads triple
AB	Outdoor cable with lighting protection	HX cross-linked, halogen-free polymer compound	TiC	triple in copper wire braid
AD	Outdoor cable with differential protection	...IMF individual stranding element (pairs or single cores etc.) in metal foil and drain wire	TiMF	triple in metal foil
AJ-	Outdoor cable with induction protection	IMF several stranding elements in metalfoil and drain wire	U	braiding of textile fibres
ASLH	self-supporting communication cables for high voltage overhead lines	-J cable with green-yellow earth core	VGd	gold-plated
B	armouring	-JZ cable with green-yellow earth core and cores with imprinted numbers	VN	nickel-plated; VS silver-plated
B	spinning of textile yarn	K copper-tape	VZK	galvanized; VZN tinned
b	armouring	(K) inner sheath and longitudinally folded copper tape	W	corrugated steel sheath
(1B...)	one layer of steel tape... thickness of the steel tape in mm	LA tinsel conductor (flat copper wire stranded over the thread of synthetic fibres)	W	high heat resistant
(2B...)	two layers of steel tape... thickness of the steel tape in mm	LD corrugated aluminium sheath	W	corrugated steel sheath
BD	unit-type stranding	Lg in layers stranding	X	cross-linked polyvinylchlorid (X-PVC) or other materials
BLK	bare copper-conductor without insulation	Li stranded wires conductor	XPE	cross-linked polyethylene (X-PE)
BZ	bronze conductor	(LY) laminated sheath Al-tape and PVC-jacket	2X	cross-linked polyethylene
C	screen of copper wire braiding	(L)2Y laminated sheath Al-tape and PE-jacket	7X	cross-linked Ethylentetrafluorethylen (X-ETFE)
C	screen of copper wire spinning	2L double enamel coating as insulation	10X	cross-linked Polyvinylidenfluorid (X-PVDF)
C	outer protection of jute and viscous compound	M plastic-sheath cable	Y	PVC, polyvinylchloride
Cu	copper wire	M lead sheath	Yu	PVC, polyvinylchloride, non-flammable, flame-retardant
(-Cu)	total cross-section of copper screens (mm <sup>2</sup> )	Mz alloyed lead sheath	Yv	PVC, polyvinylchloride, with reinforced sheath
D	screen of copper wires	(mS) magnetic shield	YV	Equipment wires with tinned conductor
(D)	screen of helically applied copper wires	N VDE standard	Yw	PVC, polyvinylchlorid, heat resistant up to 90°C
DM	Dieselhorst-Martin quad	(N) in adapted to VDE standard	2Y	Polyethylene (PE)
Dreier	three cores in triple stranded	NC non-corrosiv, smoke-gase	2Yv	Polyethylene, reinforced sheath
E	copper drain wire	NF natural colour	02Y	Cellular polyethylene
E(e)	protective covering of viscous compound with embedded layer of plastic tape	-O cable without green-yellow earth core	02YS	insulation of cellular polyethylene with outer PE-skin
e	single wire, solid	-OZ cable without green-yellow earth core and cores with imprinted numbers	2YHO	insulation of air-spaced polyethylene
f	cable cores assembly with petrol-jelly	ö oil-resistant	3Y	insulation polystyrene (PS), Styroflex
F	foil wrapping	02Y Foam-PE, insulation (cellular PE)	4Y	insulation or jacket of polyamide (PA)
F	flat cable	Q Steel wire braiding	5Y	insulation or jacket of polytetrafluorethylene (PTFE), HELUFLON®
F	star quad for railway cable	(R...) round wire, diameter in mm	5YX	Perfluoralkoxy (PFA)
F	star quad for phantom circuits	RAGL- Compensating cable for thermocoupling	6Y	Perfluoroethylene-propylene (FEP), HELUFLON®
(F...)	flat wire armouring... thickness in mm	RD- Rhenomatic cable	7Y	insulation or jacket of ethylentetrafluorethylen (ETFE)
OF	jelly filled cable core, filling compound of hard substances	RE Computer cable	8Y	insulation of polyimid (PI), Kapton®
FR	flame retardant	RG- Coaxial cable according MIL specification	9Y	polypropylen (PP)
f	flexible, fine wire stranding	re round, single wire	10Y	PVDF, Polyvinylidene fluoride
ff	extra fine wire stranding	rm round, multiwire	11Y	polyurethan (PUR)
G	insulation or sheath material of rubber (NR) or (SBR)	RS- computer switchboard cable	12Y	TPE-E, TPE
G-	Mining cable	S silk whipping	13Y	TPE-EE, TPE on base of Polyester-Ester
GJ	Mining cable with induction protection	S signal cables for railways	31Y	TPE-S, TPE on base of Polystyrol
GS	glass fibre whipping or braiding	(S...) nominal value of mutual capacitance (nF /km)	41Y	TPE-A, TPE on base of Polyamide
2G	insulation or jacket of silicone rubber, (SIR)	-S signal cable for German Railway	51Y	PFA, Perfluor-Alkoxylalkane
3G	insulation or jacket of ethylene propylene rubber, (EPR)	S- Switchboard cable	71Y	ECTFE, Monochlorotrifluorethylene
4G	insulation or jacket of ethylene vinylacetate rubber (EVA)	SL flexible sheathed cable	91Y	TPE-O, TPE on base of Polyester-Ester
5G	insulation or jacket of chloroprene rubber (CR)	2S two layers of silk whipping	-Z	core imprinted with numbers
6G	insulation or jacket of chlorosulphonated polyethylene (CSM), Hypalon	St star quad for phantom circuits	Z	twin cable
7G	insulation or jacket of Flouroelastomer (FKM)	St I star quad in telephone cables for lager distance	(Z)	high-tensile braid of steel wires
8G	insulation or jacket of Nitrile rubber (NBR)	St III star quad in local cables	(ZG)	high-tensile element of glass fibre yarn
9G	PE-C rubber (CM)	(St) static screen	(ZN)	high-tensile of non-metallic elements
53G	CM, chlorinated Polyethylene	Staku copper clad steel wire		
H	insulation or jacket of halogen-free compound	Staku-Li copper clad steel stranded wires		
H	Harmonized Documents	...t termite protection		
		T supporting element for overhead cable		

# AWG-WIRES AND AWG-STRANDED CONDUCTORS

## CONDUCTOR MAKE-UP, CROSS-SECTION, RESISTANCE AND WEIGHT

AWG No.	AWG-make-up n x AWG	conductor make-up mm	crossection mm <sup>2</sup>	conductor outer-Ø mm	conductor resistance Ohm/km	conductor weight kg/km
36	solid	solid	0,013	0,127	1460,0	0,116
36	7/44	7 x 0,05	0,014	0,152	1271,0	0,125
34	solid	solid	0,020	0,160	918,0	0,178
34	7/42	7 x 0,064	0,022	0,192	777,0	0,196
32	solid	solid	0,032	0,203	571,0	0,284
32	7/40	7 x 0,078	0,034	0,203	538,0	0,302
32	19/44	19 x 0,05	0,037	0,229	448,0	0,329
30	solid	solid	0,051	0,254	365,0	0,45
30	7/38	7 x 0,102	0,057	0,305	339,0	0,507
30	19/42	19 x 0,064	0,061	0,305	286,7	0,543
28	solid	solid	0,080	0,330	232,0	0,71
28	7/36	7 x 0,127	0,087	0,381	213,0	0,774
28	19/40	19 x 0,078	0,091	0,406	186,0	0,81
27	7/35	7 x 0,142	0,111	0,457	179,0	0,988
26	solid	solid	0,128	0,409	143,0	1,14
26	10/36	10 x 0,127	0,127	0,533	137,0	1,13
26	19/38	19 x 0,102	0,155	0,508	113,0	1,38
26	7/34	7 x 0,160	0,141	0,483	122,0	1,25
24	solid	solid	0,205	0,511	89,4	1,82
24	7/32	7 x 0,203	0,227	0,610	76,4	2,02
24	10/34	10 x 0,160	0,201	0,582	85,6	1,79
24	19/36	19 x 0,127	0,241	0,610	69,2	2,14
24	41/40	41 x 0,078	0,196	0,582	84,0	1,74
22	solid	solid	0,324	0,643	55,3	2,88
22	7/30	7 x 0,254	0,355	0,762	48,4	3,16
22	19/34	19 x 0,160	0,382	0,787	45,1	3,4
22	26/36	26 x 0,127	0,330	0,762	52,3	2,94
20	solid	solid	0,519	0,813	34,6	4,61
20	7/28	7 x 0,320	0,562	0,965	33,8	5,0
20	10/30	10 x 0,254	0,507	0,889	33,9	4,51
20	19/32	19 x 0,203	0,615	0,940	28,3	5,47
20	26/34	26 x 0,160	0,523	0,914	33,0	4,65
20	41/36	41 x 0,127	0,520	0,914	32,9	4,63
18	solid	solid	0,823	1,020	21,8	7,32
18	7/26	7 x 0,404	0,897	1,219	19,2	7,98
18	16/30	16 x 0,254	0,811	1,194	21,3	7,22
18	19/30	19 x 0,254	0,963	1,245	17,9	8,57
18	41/34	41 x 0,160	0,824	1,194	20,9	7,33
18	65/36	65 x 0,127	0,823	1,194	21,0	7,32
16	solid	solid	1,310	1,290	13,7	11,66
16	7/24	7 x 0,511	1,440	1,524	12,0	12,81
16	65/34	65 x 0,160	1,310	1,499	13,2	11,65
16	26/30	26 x 0,254	1,317	1,499	13,1	11,72
16	19/29	19 x 0,287	1,229	1,473	14,0	10,94
16	105/36	105 x 0,127	1,330	1,499	13,1	11,84
14	solid	solid	2,080	1,630	8,6	18,51
14	7/22	7 x 0,643	2,238	1,854	7,6	19,92
14	19/27	19 x 0,361	1,945	1,854	8,9	17,31
14	41/30	41 x 0,254	2,078	1,854	8,3	18,49
14	105/34	105 x 0,160	2,111	1,854	8,2	18,79

AWG No.	AWG-make-up n x AWG	conductor make-up mm	crosssection mm <sup>2</sup>	conductor outer-Ø mm	conductor resistance Ohm/km	conductor weight kg/km
12	solid	Solid	3,31	2,05	5,4	29,46
12	7/20	7 x 0,813	3,63	2,438	4,8	32,30
12	19/25	19 x 0,455	3,09	2,369	5,6	27,50
12	65/30	65 x 0,254	3,292	2,413	5,7	29,29
12	165/34	165 x 0,160	3,316	2,413	5,2	29,51
10	solid	solid	5,26	2,59	3,4	46,81
10	37/26	37 x 0,404	4,74	2,921	3,6	42,18
10	49/27	49 x 0,363	5,068	2,946	3,6	45,10
10	105/30	105 x 0,254	5,317	2,946	3,2	47,32
8	49/25	49 x 0,455	7,963	3,734	2,2	70,87
8	133/29	133 x 0,287	8,604	3,734	2,0	76,57
8	655/36	655 x 0,127	8,297	3,734	2,0	73,84
6	133/27	133 x 0,363	13,764	4,676	1,5	122,49
6	259/30	259 x 0,254	13,123	4,674	1,3	116,79
6	1050/36	1050 x 0,127	13,316	4,674	1,3	118,51
4	133/25	133 x 0,455	21,625	5,898	0,80	192,46
4	259/27	259 x 0,363	26,804	5,898	0,66	238,55
4	1666/36	1666 x 0,127	21,104	5,898	0,82	187,82
2	133/23	133 x 0,574	34,416	7,417	0,50	306,30
2	259/26	259 x 0,404	33,201	7,417	0,52	295,49
2	665/30	665 x 0,254	33,696	7,417	0,52	299,89
2	2646/36	2646 x 0,127	33,518	7,417	0,52	298,31
1	133/22	133 x 0,643	43,187	8,331	0,40	384,37
1	259/25	259 x 0,455	42,112	8,331	0,41	374,80
1	817/30	817 x 0,254	41,397	8,331	0,42	368,43
1	2109/34	2109 x 0,160	42,403	8,331	0,41	377,39
1/0	133/21	133 x 0,724	54,75	9,347	0,31	487,28
1/0	259/24	259 x 0,511	53,116	9,347	0,32	472,73
2/0	133/20	133 x 0,813	69,043	10,516	0,25	614,48
2/0	259/23	259 x 0,574	67,021	10,516	0,25	596,49
3/0	259/22	259 x 0,643	84,102	11,786	0,20	748,51
3/0	427/24	427 x 0,511	87,570	11,786	0,19	779,37
4/0	259/21	259 x 0,724	106,626	13,259	0,16	948,97
4/0	427/23	427 x 0,574	110,494	13,259	0,15	983,39

## ■ AWG-WIRES (SOLID-CONDUCTOR)

AWG No.	Wire-Ø mm	AWG No.	Wire-Ø mm	AWG No.	Wire-Ø mm	AWG No.	Wire-Ø mm
44	0,050	30	0,254	18	1,024	6	4,115
41	0,070	29	0,287	17	1,151	5	4,620
40	0,079	28	0,320	16	1,290	4	5,189
39	0,089	27	0,363	15	1,450	3	5,827
38	0,102	26	0,404	14	1,628	2	6,543
37	0,114	25	0,455	13	1,829	1	7,348
36	0,127	24	0,511	12	2,052	1/0	8,252
35	0,142	23	0,574	11	2,304	2/0	9,266
34	0,160	22	0,643	10	2,588	3/0	10,404
33	0,180	21	0,724	9	2,906	4/0	11,684
32	0,203	20	0,813	8	3,268		
31	0,226	19	0,912	7	3,665		

# STRANDED MAKE-UP (DIN VDE 0295, IEC 60228 bzw. HD 383)

cross-section	stranded wires		multistranded wires		fine wires		extra-fine wires							
	Class 2 DIN VDE 0295				Class 5 DIN VDE 0295		Class 6 DIN VDE 0295							
	column 1		column 2		column 3		column 4		column 5		column 6		column 7	
	wire number x	single of wire-Ø	wire number x	single of wire-Ø	wire number x	single of wire-Ø	wire number x	single of wire-Ø	wire number x	single of wire-Ø	wire number x	single of wire-Ø	wire number x	single of wire-Ø
mm		mm		mm		mm		mm		mm		mm		
0,14						18x0,1		18x0,1		18x0,1		36x0,07		72x0,5
0,25						14x0,15		32x0,1		32x0,1		65x0,07		128x0,5
0,34			7x0,25			19x0,15		42x0,1		42x0,1		88x0,07		174x0,5
0,38			7x0,27			12x0,2		21x0,15		48x0,1		100x0,07		194x0,5
0,5	7x0,30		7x0,30			16x0,2		28x0,15		64x0,1		131x0,07		256x0,5
0,75	7x0,37		7x0,37			24x0,2		42x0,15		96x0,1		195x0,07		384x0,5
1,0	7x0,43		7x0,30			32x0,2		56x0,15		128x0,1		260x0,07		512x0,5
1,5	7x0,52		7x0,37			30x0,25		84x0,15		192x0,1		392x0,07		768x0,5
2,5	7x0,67		7x0,43			50x0,25		140x0,15		320x0,1		651x0,07		1280x0,5
4	7x0,85		7x0,52			56x0,3		224x0,15		512x0,1		1040x0,07		
6	7x1,05		19x0,41			84x0,3		192x0,2		768x0,1		1560x0,07		
10	7x1,35		19x0,52			80x0,4		320x0,2		1280x0,1		2600x0,07		
16	7x1,70		19x0,64			128x0,4		512x0,2		2048x0,1				
25	7x2,13		49x0,65			200x0,4		800x0,2		3200x0,1				
35	7x2,52		84x0,62			280x0,4		1120x0,2						
50	19x1,83		133x0,58			400x0,4		705x0,3						
70	19x2,17		133x0,69			356x0,5		990x0,3						
95	19x2,52		189x0,69			485x0,5		1340x0,3						
120	37x2,03		259x0,69			614x0,5		1690x0,3						
150	37x2,27		336x0,67			765x0,5		2123x0,3						
185	37x2,52		392x0,69			944x0,5		1470x0,4						
240	61x2,24		494x0,69			1255x0,5		1905x0,4						
300	61x2,50		627x0,70			1530x0,5		2385x0,4						
400	61x2,89		790x0,70			2035x0,5								
500	61x3,23					1768x0,6								

1) The number of individual wires are without obligation.

2) The diameters of the single wires for each conductor are not allowed to exceed the values stated to DIN VDE 0295. The single wires of a stranded conductor must have all the same nominal diameters.

3) Minimum-number of single wires of stranded conductor (up to 35 mm<sup>2</sup>). The single wires of a stranded conductor must have all the same nominal diameters.

2) **Note:** permissible maximal diameter of single wires:

nominal value	maximal value
mm	mm
0,2	0,21
0,25	0,26
0,3	0,31
0,4	0,41
0,5	0,51
0,6	0,61

## Comparison AWG-measurements to metrical cross-sections (mm<sup>2</sup>)

AWG	mm <sup>2</sup>	AWG	mm <sup>2</sup>	AWG	mm <sup>2</sup>	AWG	mm <sup>2</sup>
30	0,05	18	0,75	6	16	300 MCM	150
28	0,08	17	1,00	4	25	350 MCM	185
26	0,14	16	1,50	2	35	500 MCM	240
24	0,25	14	2,50	1	50	600 MCM	300
22	0,34	12	4	2/0	70	750 MCM	400
21	0,38	10	6	3/0	95	1000 MCM	500
20	0,50	8	10	4/0	120		

This cross reference list shows equivalent nominal values. Actual cross sections may vary. The AWG values are approximate, if the cables are made to European Standards (mm<sup>2</sup>) and vice versa. In critical applications, where the current reaches upper limits. The deviating operation conditions for installation and laying according to standards are to be taken into consideration.



# ■ US-AMERICAN AND BRITISH UNITS

## Conversion of usual measuring units

In the USA the measurements are mainly used in AWG-numbers (AWG = American Wire Gauge). The AWG-numbers conform the british B&S-numbers (BS = Brown & Sharp) überein.

AWG No.	Crosssection mm <sup>2</sup>	Diameter mm	Conductor resistance Ohm/km
1000 MCM*	507	25,4	0,035
750	380	22,0	0,047
600	304	19,7	0,059
500	254	20,7	0,07
400	203	18,9	0,09
350	178	17,3	0,10
300	152	16,0	0,12
250	127	14,6	0,14
4/0	107,20	11,68	0,18
3/0	85,00	10,40	0,23
2/0	67,50	9,27	0,29
0	53,40	8,25	0,37
1	42,40	7,35	0,47
2	33,60	6,54	0,57
3	26,70	5,83	0,71
4	21,20	5,19	0,91
5	16,80	4,62	1,12
6	13,30	4,11	1,44
7	10,60	3,67	1,78
8	8,366	3,26	2,36
9	6,63	2,91	2,77
10	5,26	2,59	3,64
11	4,15	2,30	4,44
12	3,30	2,05	5,41
13	2,62	1,83	7,02

4/0 wird auch geschrieben: 0000; 1 mil = 0,001 inch = 0,0254 mm  
\* bei größerem Querschnitt Maßangaben in MCM (circular mils)

AWG No.	Crosssection mm <sup>2</sup>	Diameter mm	Conductor resistance Ohm/km
14	2,08	1,63	8,79
15	1,65	1,45	11,20
16	1,31	1,29	14,70
17	1,04	1,15	17,80
18	0,8230	1,0240	23,0
19	0,6530	0,9120	28,3
20	0,5190	0,8120	34,5
21	0,4120	0,7230	44,0
22	0,3250	0,6440	54,8
23	0,2590	0,5730	70,1
24	0,2050	0,5110	89,2
25	0,1630	0,4550	111,0
26	0,1280	0,4050	146,0
27	0,1020	0,3610	176,0
28	0,0804	0,3210	232,0
29	0,0646	0,2860	282,0
30	0,0503	0,2550	350,0
31	0,0400	0,2270	446,0
32	0,0320	0,2020	578,0
33	0,0252	0,1800	710,0
34	0,0200	0,1600	899,0
35	0,0161	0,1430	1125,0
36	0,0123	0,1270	1426,0
37	0,0100	0,1130	1800,0
38	0,00795	0,1010	2255,0
39	0,00632	0,0897	2860,0

1 CM = 1 Circ. mi. = 0,0005067 mm<sup>2</sup>  
1 MCM = 1000 Circ. mils = 0,5067 mm<sup>2</sup>

## General measuring units

Length	
1 mil	= 0,0254 mm
1 in (Inch)	= 25,4 mm
1 ft (foot)	= 0,3048 m
1 yd (yard)	= 0,9144 m
1 ch (chain)	= 20,1 m
1 mile (land mile)	= 1,609 km/ 1760 yards
1 mile (nautic mile)	= 1,852 km
1 mm	= 0,039370 inches
1 m	= 39,370079 inches
Area	
1 CM (circ. mil)	= 0,507 · 10 <sup>-3</sup> mm <sup>2</sup>
1 MCM	= 0,5067 mm <sup>2</sup>
1 sq. inch	= 645,16 mm <sup>2</sup>
1 sq. foot	= 0,0929 m <sup>2</sup>
1 square yard	= 0,836 m <sup>2</sup>
1 acre	= 4047 m <sup>2</sup>
1 square mile	= 2,59 km <sup>2</sup>
Density	
1 cu. in. (cubic inch)	= 16,39 cm <sup>3</sup>
1 cu. ft. (cubic foot)	= 0,0283 m <sup>3</sup>
1 cu. yd. (cubic yard)	= 0,7646 m <sup>3</sup>
1 gal. (US gallon)	= 3,785 l
1 gal. brit gallon	= 4,546 l
1 US pint	= 0,473 l
1 US quart	= 0,946 l
1 US barrel	= 158,8 l
Temperature	
F (Fahrenheit)	= (1,8 · C) + 3°
C (Celsius)	= 0,5556 · (F-32°)

Weight	
1 grain	= 64,8 mg
1 dram	= 1,77 g
1 oz (ounce)	= 28,35 g
1 lb (pound)	= 0,4536 Kp
1 stone	= 6,35 Kp
1 qu (quarter)	= 12,7 Kp
1 US-cwt (hundred-weight)	= 45,36 Kp
1 US ton (short ton)	= 0,907 t
1 brit. ton (long ton)	= 1,016 t
Force	
1 lb	= 4,448 N
1 brit. ton	= 9954 N
1 pdl (Poundal)	= 0,1383 N
1 kp	= 9,81 N
1 N	= 1,02 kp
Velocity	
1 mile/h	= 1,609 km/h
1 Knoten	= 1,852 km/h
1 ft/s	= 0,305 m/s
1 ft/min	= 5,08 · 10 <sup>-3</sup> m/s
Energy	
1 lb/mile	= 0,282 kg/m
1 lb/yard	= 0,496 kg/m
1 lb/foot	= 1,488 kg/m
Radiation absorbed dose	
1 Gray	= 1J/kg
1 rad	= 10 <sup>-2</sup> J/kg = 1 Centi Gy
1 Centi	= 100 Joule
1 rad	= cJ/kg = 0,01 Gy
1 Mrad	= 1 · 10 <sup>6</sup> cJ/kg

Pressure	
1 psi (lb/sq.)	= 68,95 mbar = 6,895 · 10 <sup>-3</sup> Nmm <sup>2</sup>
1 lb/sq. ft	= 0,478 mbar
1 pdl/sq. ft.	= 1,489 N/m <sup>2</sup>
1 in Hg	= 33,86 mbar
1 ft H <sub>2</sub> O	= 29,89 mbar
1 in H <sub>2</sub> O	= 2,491 mbar
1 N/mm <sup>2</sup>	= 145 psi / 10 bar
1 kp/mm <sup>2</sup>	= 1422 psi
1 at	= 736 Torr / 1 kp/cm <sup>2</sup>
1 Torr	= 1 mm Hg
1 bar	= 0,1 H Pa
1 Pa	= 1 N/m <sup>2</sup>
Density	
1 lb/cu. ft	= 16,02 kg/m <sup>3</sup>
1 lb/cu. in.	= 27,68 t/m <sup>3</sup>
Horse power	
1 hp · h	= 1,0139 PS · h
	= 2,684 · 10 <sup>6</sup> Joule
	= 746 W · h
1 BTU (brit. therm. unit)	= 1055 Joule
Electrical units	
1 ohm/1000 yd	= 1,0936 Ω/km
1 ohm/1000ft	= 3,28 Ω/km
1 μF/mile	= 0,62 μF/km
1 megohm/mile	= 1,61 MΩ/km
1 μpf/foot	= 3,28 pF/m
1 decible/mile	= 71,5 mN/m
Power rate	
1 PS	= 0,736 kW
1 kW	= 1,36 PS
1 hp	= 0,7457 kW
1 kW	= 1,31 hp

# ■ COPPER AND ALU-PRICE CALCULATION

Calculation examples:

- Assumption:
- DEL-Quotation 194,29 EUR/100 kg for copper
  - Daily rate 173,84 EUR/100 kg for aluminium
  - Individual discount, e. g. 20%

## 1. Profibus 1 x 2 x 0,64 mm, PVC, Part no. 81448

Quantity ordered 1000 m

Price brutto (Copper base)= 150 EUR 1400,00 EUR/km  
minus 20% (discount) 280,00 EUR/km

1120,00 EUR/km

+ Copper surcharge:

$\frac{(194,29 + 1,9429) - 150}{100}$  x Copper value

equal, 0,4623 EUR/kg x 22 kg/km =

10,17 EUR/km  
1130,17 EUR/km

## 2. NYCWY 3 x 70/35 sm, 0,6/1 kV, Part No. 32268

Quantity ordered 1000 m

Copper base = 0 14780,00 EUR/km  
minus 20% (discount) 2956,00 EUR/km

11824,00 EUR/km

+ Copper surcharge (Conductor + screen):

$\frac{(194,29 + 1,9429) - 0}{100}$  x Copper value

equal, 1,962 EUR/kg x 2410 kg/km =

4728,42 EUR/km  
16552,42 EUR/km

## 3. NA2XSY 1 x 70 sm/16, 12/20 kV, Part No. 32454

Quantity ordered 1000 m

- Aluminium conductor  
- Copper screen

Copper base = 0 9500,00 EUR/km  
minus 20% (discount) 1900,00 EUR/km

7600,00 EUR/km

+ Copper surcharge (screen):

$\frac{(194,29 + 1,9429) - 0}{100}$  x Copper value

equal, 1,962 EUR/kg x 182 kg/km =

357,08 EUR/km

+ Aluminium (Conductor):

Aluminium value x daily rate  
203 kg/km x 1,74 EUR/kg

353,22 EUR/km  
8310,30 EUR/km

# LAN-CABLE DESIGNATION

**U/UTP (UTP\*)**

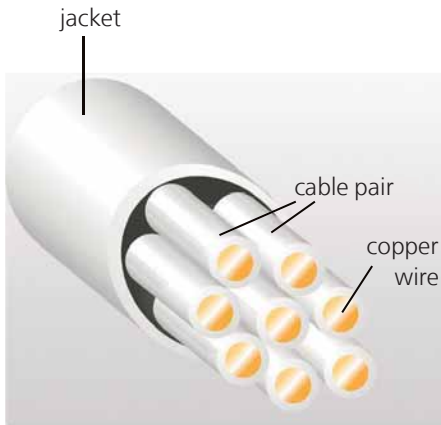

**F/UTP (FTP\*)**

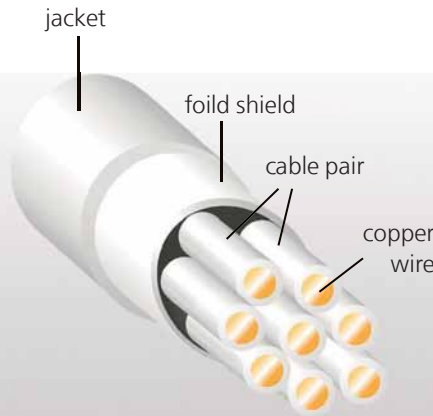

**U/FTP (STP\*)**

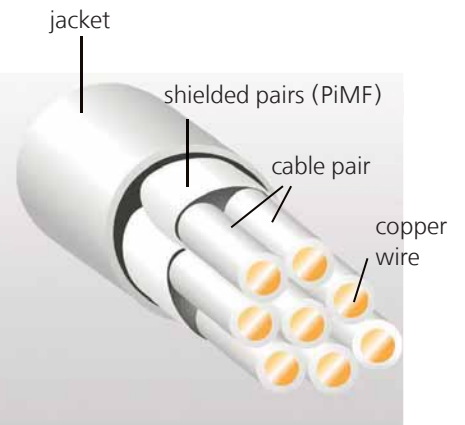

**SF/UTP (S-FTP\*)**

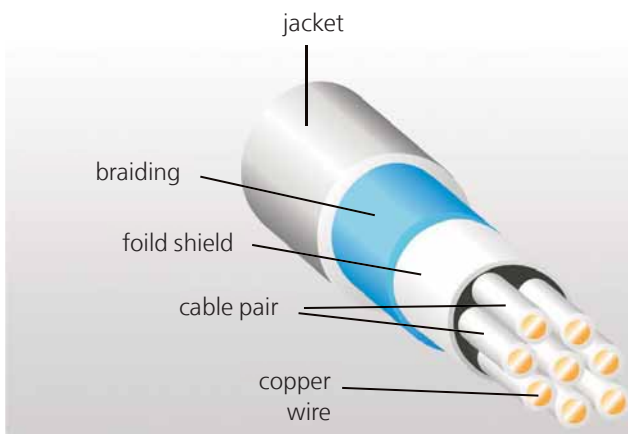

**S/FTP (S-STP\*)**

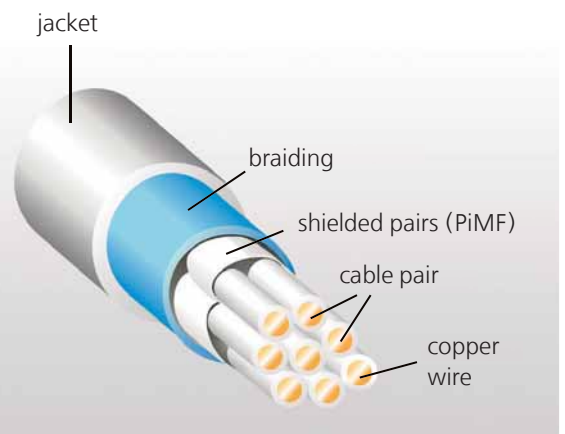

**U/UTP (UTQ\*)**

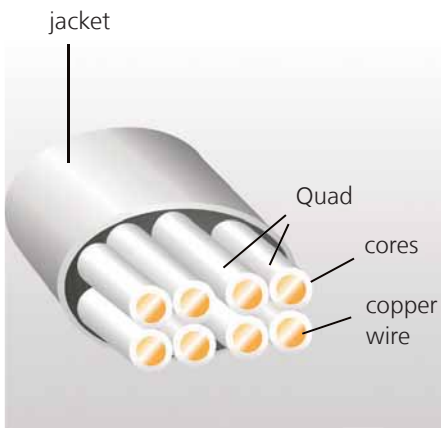

**U/FTP (S-STQ\*)**

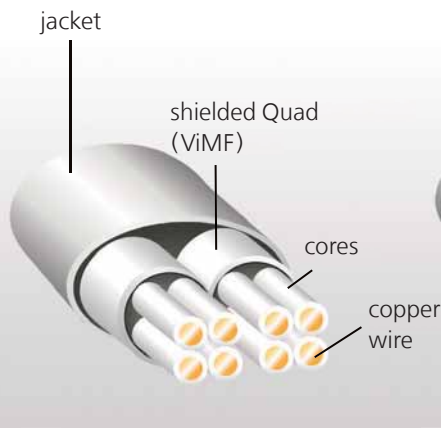

**S/FTP (S-STQ\*)**

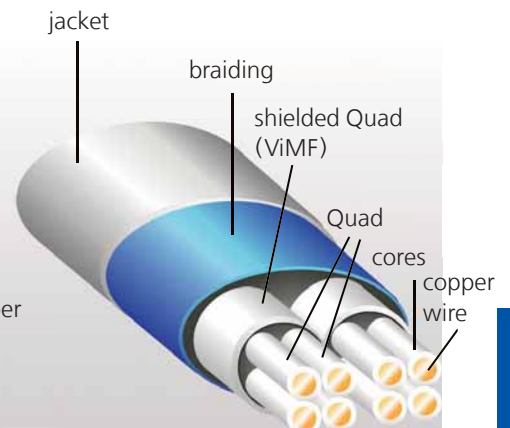

\*Old term

# RJ45 CONNECTOR PIN ASSIGNMENT FOR ETHERNET APPLIKATIONS

## Ethernet RJ45

The 8-pole RJ45 is available with the connection diagram according to EIA/TIA T568A and EIA/TIA T568B has the 8-pole RJ45 plug connector. The twisted pair cable must be connected to 8-pole RJ45 sockets and comply with one of the two standards. The standard mainly used is EIA/TIA T568B while EIA/TIA T568A (AT&T) is less common.

### MDI (EIA/TIA T568A)

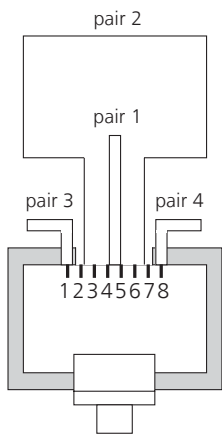

Pin	Colour code Wire	Assignment 10BASE-T, 100BASE-TX	Assignment 1000BASE-TX
1	WHT/GRN	Tx+	BI_DA+
2	GRN	Tx-	BI_DA-
3	WHT/ORG	Rx+	BI_DB+
4	BLU		BI_DC+
5	WHT/BLU		BI_DC-
6	ORG	Rx-	BU_DB+
7	WHT/BRN		BI_DD+
8	BRN		BI_DD-

### MDI-X

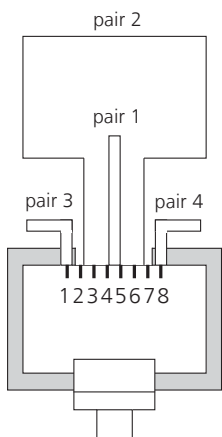

Pin	Colour code Wire	Assignment 10BASE-T, 100BASE-TX	Assignment 1000BASE-TX
1	WHT/ORG	Rx+	BI_DB+
2	ORG	Rx-	BI_DB-
3	WHT/GRN	Tx+	BI_DA+
4	BLU		BI_DD+
5	WHT/BLU		BI_DD-
6	GRN	Tx-	BU_DA-
7	WHT/BRN		BI_DC+
8	BRN		BI_DC-

### MDI (EIA/TIA T568B)

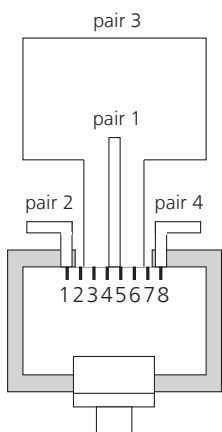

Pin	Colour code Wire	Assignment 10BASE-T, 100BASE-TX	Assignment 1000BASE-TX
1	WHT/ORG	Tx+	BI_DA+
2	ORG	Tx-	BI_DA-
3	WHT/GRN	Rx+	BI_DB+
4	BLU		BI_DC+
5	WHT/BLU		BI_DC-
6	GRN	Rx-	BU_DB-
7	WHT/BRN		BI_DD+
8	BRN		BI_DD-

**Note:** Other technologies such as Token Ring, FDDI etc. use different pin assignments

# RJ45 WIRING OPTIONS

Two different patch cables are used in Ethernet networks - the straight-through and the crossover cable.

## Straight-through patch cable

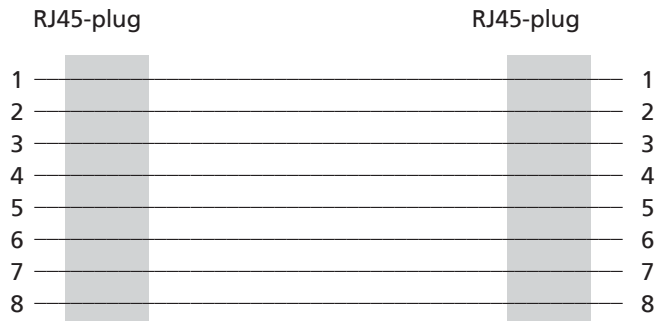

A straight-through cable is used if an Ethernet switch should be connected to the network connection of a computer.

## Crossover cable

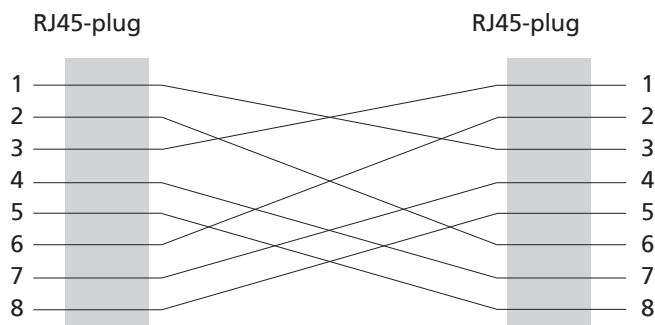

A crossover cable is used if two Ethernet switches or two computers should be connected with each other via their network connections.

**Note:** Suitable for all Ethernet technologies

## Semi crossover

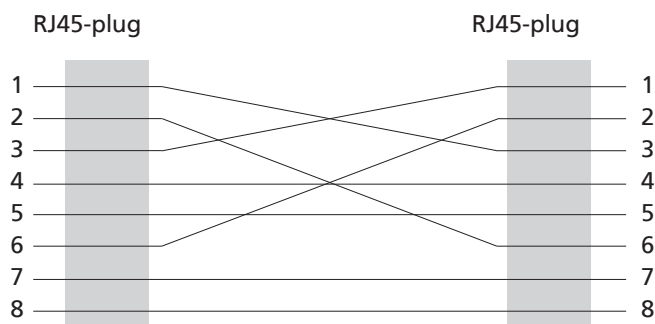

A crossover cable is used if two Ethernet switches or two computers should be connected with each other via their network connections.

**Note:** Not suitable for Gigabit Ethernet because this technology uses all pins.

# M12 CONNECTOR PIN ASSIGNMENT

## Ethernet M12 connection diagram 4-poled

(IEC 61076-2-101)

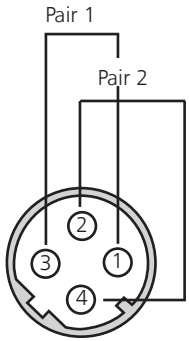

Pin	Colour Code	Assignment 10BASE-T 100BASE-TX
1	BLU/YEL	Tx+
2	YEL/WHT	Rx+
3	WHT/ORG	Tx-
4	ORG/BLU	Rx-

D-Coding for Industrial Ethernet

## Ethernet M12 connection diagram 8-poled

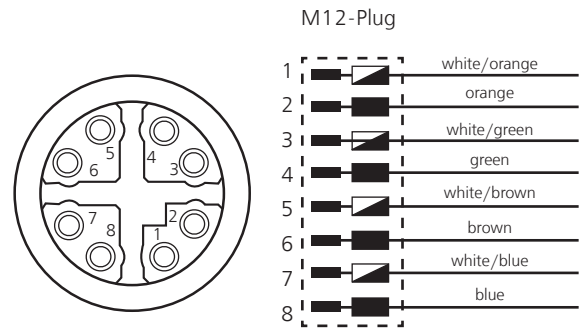
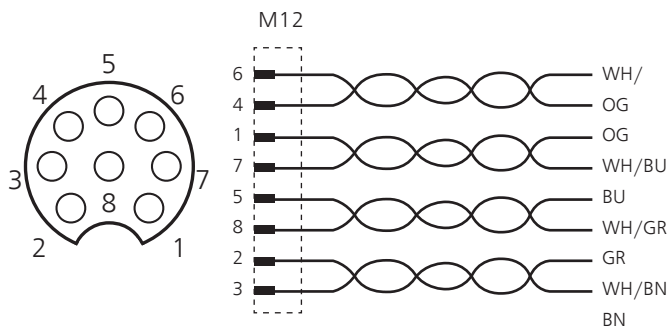

A-Coded Kat.5

X-Coding Kat.5 / 6 bzw. 6<sub>A</sub>

## Profibus M12 connection diagram

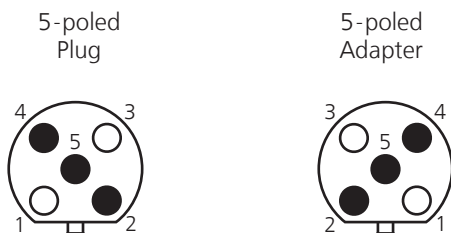

PIN 2: A-Line (grün)  
 PIN 4: A-Line (rot)  
 PIN 5: Shield  
 Thread connection: Shield

B-Coding for Profibus

## DeviceNet™ M12 connection diagram

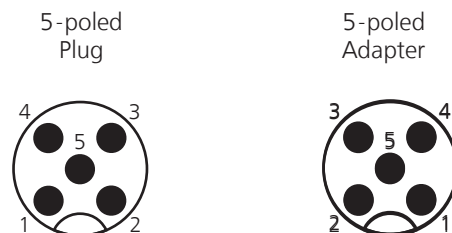

PIN 1: Shield  
 PIN 2: V+  
 PIN 3: V-  
 PIN 4: CAN\_H  
 PIN 5: CAN\_L  
 Threaded connection: shield

A-Coding for DeviceNet™

# STANDARDS OVERVIEW

## Standards overview: application-neutral cabling systems

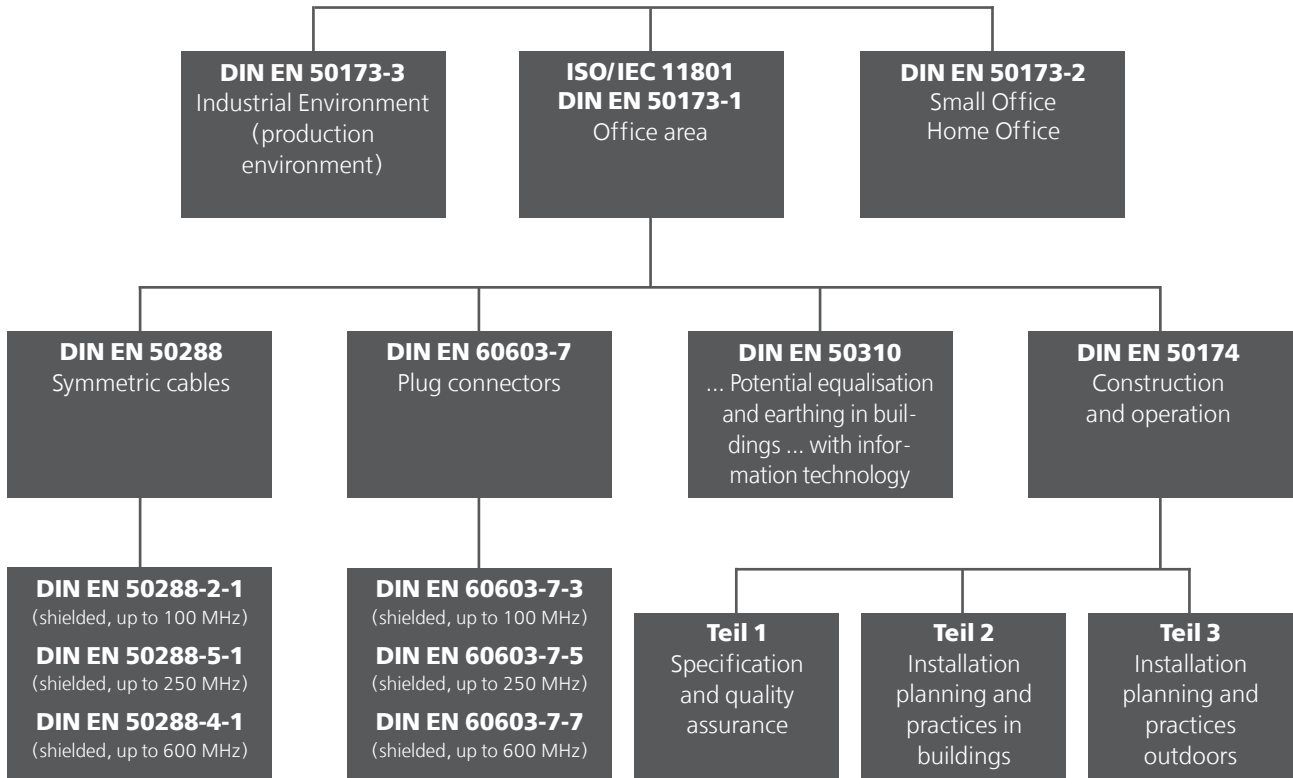

The EN 50173 and ISO/IEC 11801 standards today are largely identical and contain the same requirements for cables and components.

Both standards are currently being revised and a complete harmonisation is being striven for.

The requirements for components (categories) are also specified in the following standards:

- Cables EN 50288
- Mating faces EN 60603-7 and IEC 61076-3-104
- Measuring equipment EN 651935

The EN standards also include the European EMC regulations:

- Radiation Class A/B EN 55022
- Interference resistance EM 50082-1

Building cabling in EN 50173 just like in ISO/IEC 11801 is divided into three areas:

- Primary or campus area for connecting the buildings of one site with each other
- Secondary or vertical area for connecting the separate floors of a building
- Tertiary or horizontal area for connecting the connection units (e.g. wall sockets) with the floor distributor

The IEEE Standards Association (IEEE-SA) is an organisation where all activities and programmes concerning IEEE standards are carried out under one roof.

The IEEE 802 LAN/MAN Standards Committee develops standards for local area networks and metropolitan area networks.

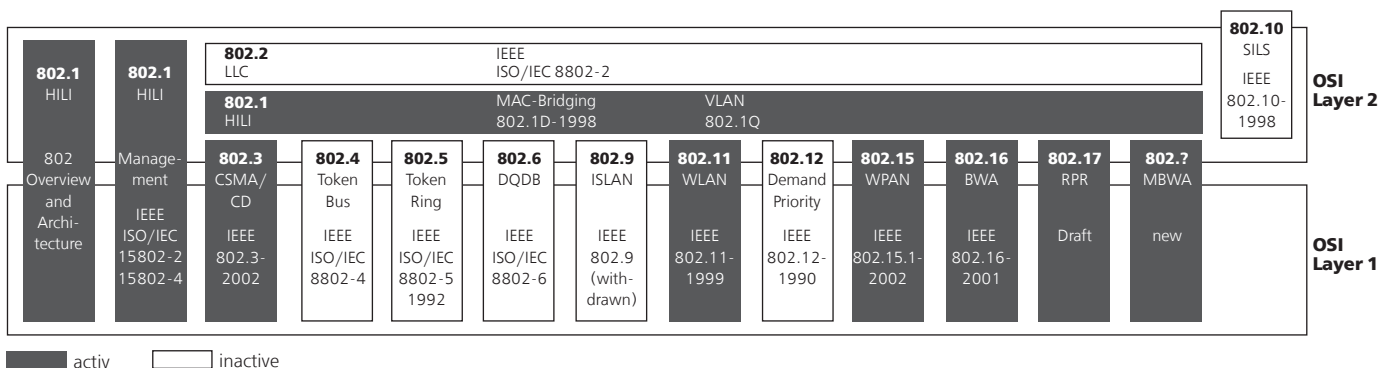

■ activ □ inactive

# ■ IP-CODE (PROTECTION CLASSES)

## Definition of protection classifications according to EN 60529

The IEC 60529 standard „Protection classifications using enclosure (IP Code)“ provides a system for classifying the protection ratings of electrical operating materials by enclosure. This standard defines terms for the protection classifications by enclosure concerning:

- Protection of persons against access to dangerous parts inside the enclosure
- Protection of operating material inside the enclosure against ingress by solid foreign substances
- Protection of operating material inside the enclosure against damage by the ingress of water

Protection level against solid foreign bodies			Protection level against water		
First number	Short description	Definition	Second number	Short description	Definition
0	Not protected	The object sensor, a 50 mm ball, must not fully penetrate.	0	Not protected	Vertically falling droplets must not have a damaging effect.
1	Protected against solid foreign bodies of 50 mm diameter and larger	The object sensor, a 12.5 mm ball, must not fully penetrate.	1	Protected against dripping water	Vertically falling droplets must not have a damaging effect if the enclosure is tilted by an angle of up to 15° on both sides of the perpendiculars.
2	Protected against solid foreign bodies of 12.5 mm diameter and larger	The object sensor, a 2.5 mm diameter ball, must not penetrate at all.	2	Protection against dripping water if the enclosure is tilted by up to 15°.	Water sprayed at both sides of the perpendiculars at an angle of up to 60° must not have a damaging effect.
3	Protected against solid foreign bodies of 2.5 mm diameter and larger	The object sensor, a 2.5 mm diameter ball, must not penetrate at all.	3	Protected against spray water	Water sprayed against the enclosure from one direction must not have a damaging effect.
4	Protected against solid foreign bodies of 1.0 mm diameter and larger	The object sensor, a 1.0 mm diameter ball, must not penetrate at all.	4	Protected against spray water	Water sprayed against the enclosure in a jet from every direction must not have a damaging effect. Protected against spray water at increased pressure
			4K	Protected against water with high pressure	Water sprayed against the enclosure from any direction at increased pressure must not have any damaging effects. (Only applies to road vehicles according to DIN 40 050 Part 9)
			5	Protected against	Water sprayed against the enclosure in a strong jet from every direction must not have a damaging effect.
			6	Protected against strong hose water	Water sprayed against the enclosure in a strong jet from every direction must not have a damaging effect.
			6K	Protected against hose water at increased pressure	Water sprayed against the enclosure in a jet at increased pressure from every direction must not have any damaging effects. (Only applies to road vehicles according to DIN 40050 Part 9)
			7	Protected against the effect when temporarily submerged in water	Water may not enter in harmful quantities when the enclosure is held submerged.
			8	Protected against the effect when permanently submerged in water	The volume of penetrating water must not have a damaging effect when the enclosure is temporarily submerged in water at a certain pressure.
			9K	Protected against the effect when permanently submerged in water	The volume of penetrating water must not have a damaging effect when the enclosure is permanently submerged in water.

<b>Example: Letters IP 65</b>		First index: Protection against contact and ingress by foreign bodies
		Second index: Protection against liquid



# ■ FIRE PERFORMANCE AND FIRE PROPAGATION IN ACCORDANCE WITH NACH EN 60332-X

European standards EN 50167, EN 50168, and EN 50169, require not only data lines with shielding, they also require data lines with halogen-free sheathing. Consideration and compliance with these standards is particularly recommended for public facilities such as hospitals, schools, and airports. We also recommend the use of halogen-free cable for buildings with high concentration of personnel or material assets.

## Cable with PVC sheath

If there is a fire, standard PVC materials can propagate fires and form hydrochloric acid through the liberation of hydrogen chloride gas (HCl) in combination with moisture (e.g. water for fire fighting). In addition, burning PVC (polyvinyl chloride) produces high smoke density and the corrosive damage to buildings and equipment can often assume devastating proportions that far exceed the actual fire damage. HELUKAT® data lines are manufactured in accordance with IEC 60332-1-2 relative to fire propagation behaviour.

## Cable with halogen-free sheath

Here materials are used that do not contain halogens (such as chloride) and that do not release corrosive gases in the event of fire. The portion of toxic gases is also reduced to a minimum, and smoke density and fire propagation are hardly present or possible. Markings on the cable include the abbreviations FRNC or LSOH. These markings specifically refer to the following:

FR	flame retardant (inhibits fire propagation)
NC	non-corrosive (no corrosive components)
LS	low smoke (low smoke density)
OH	zero halogen (halogen-free)

For safety, when using such materials, it is essential that the view of passageways and emergency exits remains unobstructed. For this, however, it is necessary to also consider the use of such materials for other products such as power cables or cable guide channels. In terms of fire propagation behaviour, HELUKAT® data lines are manufactured in accordance with IEC 60332-1-2 or in accordance with the more rigorous IEC 60332-3-24.

## Caloric load [kWh/m] [MJ/m]

There is a wide variety of different combustible fixtures or products in every building. These include (even if concealed in suspended ceilings or channels) cables and lines that can represent a significant part of the facility, particularly in commercial premises. These cables have different energies (heating values) and they can significantly increase the total caloric value of a building. Consequently, in the planning stage ensure that caloric value quantities are kept as low as possible.

## Test methods for fire propagation

The verification or definition of how effectively or how well cable must counter fire propagation and thus the spread of the fire is specified in the standards IEC 60332-1-2, IEC 60332-2 and IEC 60332-3-24. For test method 1, a 50 cm long cable is exposed to flame from a gas burner for 1 minute, and must then extinguish any flame on its own, and it may be burned up to a maximum of 5 cm under the upper clamp. For test method 3, an entire bundle of cable, 3.5 m long is mounted vertically on a ladder in a cabinet and exposed to flame for 20 minutes. After turning off the gas burner, the flame must extinguish on its own within 1 hour and the distance between burner and the fire damage on the cables furthest removed from the burner must not exceed 2.5 m.

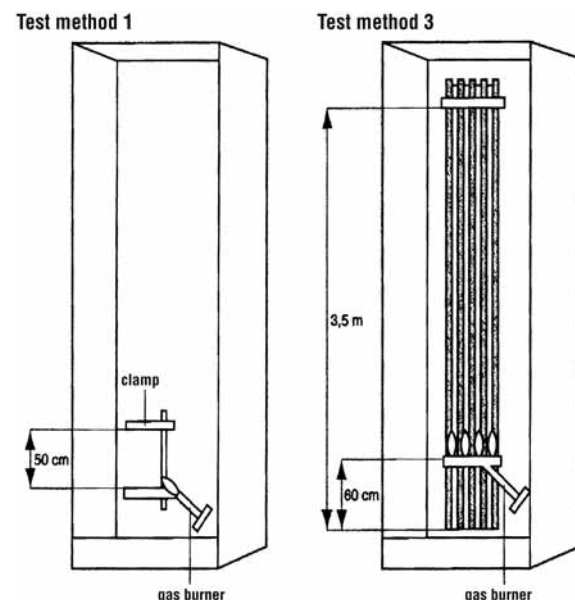

**This test is a very realistic representation of a possible fire in a cabling chute.**

# CAPACITY OF KTG-POOL DRUMS

## Wooden drums (standard)

Drumcode-numbers	Drumsize	Flange Ø	Drum-Barrel Ø	Bore Ø	Widthover all	Width for windings	Load bearing capacity max.	Drumweight
		Fd	Kd	Bd	I1	I2		
		mm	mm	mm	mm	mm	kg	kg
051	05	500	150	56	470	410	100	8
061	06	630	315	56	415	315	250	17
071	07	710	355	80	520	400	250	25
081	08	800	400	80	520	400	400	31
091	09	900	450	80	690	560	750	47
101	10	1000	500	80	710	560	900	71
121	12	1250	630	80	890	670	1700	144
141	14	1400	710	80	890	670	2000	175
161	16/8	1600	800	80	1100	850	3000	280
181	18/10	1800	1000	100	1100	840	4000	380
201	20/12	2000	1250	100	1350	1045	5000	550
221	22/12	2240	1400	125	1450	1140	6000	710
250	25/14	2500	1400	125	1450	1140	7500	875
251	25/16	2500	1600	125	1450	1130	7500	900
281	28/18	2800	1800	140	1635	1280	10000	1175

## Plastic drums

Drumcode-numbers	Flange Ø	Bore Ø	Widthover all	Width for windings	Load bearing capacity max.	Drumweight
	Fd	Bd	I1	I2		
	mm	mm	mm	mm	kg	kg
050	500	150	456	404	100	4
070	710	355	510	400	250	15
080	800	400	510	400	350	16
090	900	450	680	560	400	23
100	1000	500	704	560	500	32

## One-way wooden drums

Drumcode-numbers	Flange Ø	Bore Ø	Widthover all	Width for windings	Load bearing capacity max.	Drumweight
	Fd	Bd	I1	I2		
	mm	mm	mm	mm	mm	kg
HE 350	350	150	320	300	56	1,8
HE 400	400	150	320	300	56	2,1
HE 401	400	150	425	405	56	2,3
HE 501	500	150	320	300	56	3,0
HE 500	500	150	425	405	56	3,3
HE 600	600	150	425	405	56	4,5
HE 760	760	300	425	400	80	8,0

## ■ UL-LISTED OR UL-RECOGNIZED FOR DATA CABLES?

North America is an important market for German machinery and plant manufacturers. Customers often demand “UL approval” without, however, being acquainted with the possibilities, advantages and disadvantages of the range of approval types.

As a rule, a UL Mark tends to open up doors in this market. However, there is no approval type that applies across the board for all applications. Sometimes an approved cable will nevertheless fail to be accepted by the customer at the site. The rude awakening often comes too late, after the product has already been installed in the plant and the local inspector refuses the acceptance. In such a case, the installed cable must be removed, either completely or in part.

For example: A drag chain cable 800655 with PUR jacket has UL-Recognized AWM Style or UL-Listed CMX approval. PUR is an excellent material for cables that are in continuous motion, but is not highly flame resistant. If this cable is used not just in the chain or on the plant, but is also used in the cable trays as a connection between the machines, it is very likely that the inspector will refuse the acceptance. This is because in the USA there are different flammability requirements for stationary cable installations. For this application, the version 800653 with PVC jacket and UL-Listed CMG should be used to prevent problems with the acceptance.

### UL Recognized

UL’s Recognized Components are AWM Styles that can be listed on what is known as a “Yellow Card”. This approval type is similar to the VDE registration number: A product for the wiring of machinery/equipment is submitted to the UL with set application specifications for the voltage level, flame resistance, temperature range, etc. UL tests whether the product complies with the specified requirements and then issues either an existing AWM Style or, if the parameters do not match an existing Style, issues a new UL AWM Style. AWM (Appliance Wiring Material) components are used in UL-Listed or UL-Classified end products. The final acceptance depends on the installation and use of the complete plant.

### UL-Listed

UL-Listed, on the other hand, is an actual standard, and applies for cabling in buildings, in cabled factory equipment, as well as for field cable installations for machinery and plants. Data cables are described in the standard UL444. Depending on the application and flame resistance, the applicable standard is listed in the individual chapters, according to the respective criteria for data cables (CM, CMG, CMX...). The great advantage is that the standard is universally recognized and has a higher status / level of acceptance in the field. The inspector normally will know most of the commonly found standards without having to look them up, allowing the inspector to make a quicker decision. This approval simplifies and accelerates the acceptance in plants in these markets, and for machinery and plant manufacturers, it also significantly cuts the time and costs involved in the inspection and acceptance.

Listing Type	Typical application	Flammability test	relevant for industrial automation
<b>CMP</b> (Plenum)	highest safety requirement in respect to flame resistance (Steiner tunnel) Installation without additional protection	FT6	no
<b>CMR</b> (Riser)	Cabling in multi-storey buildings as riser, minimum 2 stories (vertical duct)	UL 1666	no
<b>CM, CMG</b> (General Purpose)	Cabling for buildings, with general use (no risers / plenum) optional PLTC approval (vertical duct)	CSA FT4	yes, Cabling in factor halls, cable trays, and in the field and machinery
<b>CMX</b> (Dwellings)	Limited use within buildings	UL 2556 VW-1 CSA FT 1	yes Field and machinery cabling

# ■ NORM-GLOSSARY

<b>IEEE 802</b>	Overview and Architecture	<b>IEEE 802.3q-1993 (Clause 5)</b>	10 Mb/s Layer Management, GDMO Format
<b>IEEE 802</b>	LMSC; LAN MAN Standard Committee	<b>IEEE 802.3r-1996 (8.8)</b>	Type 10BASE5 Medium Attachment Unit PICS proforma
<b>IEEE 802.1</b>	Higher Layer Interface Standards	<b>IEEE 802.3s-1995</b>	Maintenance 4
<b>IEEE 802.1B-1995</b>	LAN/MAN Management (ISO/IEC 15802-2:1995)	<b>IEEE 802.3t-1995</b>	120 Ohm informative annex to 10BASE-T
<b>IEEE 802.1D-1998</b>	Media access control (MAC) bridges (includes IEEE 802.1p Priority and Dynamic Multicast Filtering, GARP, GMRP)	<b>IEEE 802.3u-1995 (Clauses 21-30)</b>	Type 100BASE-T MAC parameters, Physical Layer, MAUs and Repeater for 100 Mb/s
<b>IEEE 802.1E-1994</b>	System load protocol (ISO/IEC 15802-4 : 1994)	<b>IEEE 802.3v-1995</b>	150 Ohm informative annex to 10BASE-T
<b>IEEE 802.1F-1993</b>	Common Definitions and Procedures for IEEE 802 Management Information	<b>IEEE 802.3x-1997 and 802.3y-1997</b>	(Revisions to 802.3, Clauses 31 and 32), Full Duplex Operation and Type 100BASE-T2
<b>IEEE 802.1G-1998</b>	Remote Media Access Control (MAC) bridging (ISO/IEC 15802-5 : 1998)	<b>IEEE 802.3z-1998 (Clauses 34-39,41-42)</b>	Type 1000BASE-X MAC Parameters, Physical Layer, Repeater and Management Parameters for 1000 Mb/s Operation
<b>IEEE 802.1H-1997</b>	Media Access Control (MAC) Bridging of Ethernet V2.0 in Local Area Networks (ISO/IEC TR 11802-5 : 1997)	<b>IEEE 802.3aa-1998</b>	Maintenance 5
<b>IEEE 802.1Q-1998</b>	IEEE Standard for Virtual Bridged Local Area Networks (VLAN Tagging, GVRP)	<b>IEEE 802.9ac-1998</b>	Frame Extensions for Virtual Bridged Local Area Network (VLAN) Tagging on 802.3 Networks
<b>IEEE 802.1W-2001</b>	IEEE Standard for Rapid Reconfiguration	<b>IEEE 802.3ab-1999 (Clause 40)</b>	Physical Layer Parameters and Specifications for 1000 Mb/s Operation Over 4 Pair of Category 5 Balanced Copper Cabling, Type 1000BASE-T
<b>IEEE 802.1X-2001</b>	IEEE Standard for Port-Based Network Access Control	<b>IEEE 802.3ad-2000 (Clause 43)</b>	Aggregation of Multiple Link Segments
<b>IEEE 802.2</b>	LLC; Logical Link Control	<b>An additional standard, 1802.3</b>	provides conformance test information for 10BASE-T
<b>IEEE 802.3</b>	CSMA/CD; Carrier Sense Multiple Access with Collision Detection (Ethernet)	<b>IEEE 802.3ae-2002</b>	Media Access Control (MAC) Parameters, Physical Layer, and Management Parameters for 10 Gb/s Operation
<b>IEEE 802.3a-1988 (Clause 10)</b>	10 Mb/s MAU 10BASE2	<b>IEEE 802.af</b>	in work DTE Power via MDI
<b>IEEE 802.3b-1985 (Clause 11)</b>	10 Mb/s Broadband MAU, 10BROAD36	<b>IEEE 802.3ah</b>	in work Ethernet in the First Mile
<b>IEEE 802.3c-1985 (9.1-9.8)</b>	10 Mb/s Baseband Repeater	<b>IEEE 802.4</b>	TBUS; Token bus
<b>IEEE 802.3d-1987 (9.9)</b>	10 Mb/s Fibre MAU, FOIRL	<b>IEEE 802.5</b>	TRING; Token Ring
<b>IEEE 802.3e-1987 (Clause 12)</b>	1 Mb/s MAU and Hub 1BASE5	<b>IEEE 802.6</b>	DQDB; Distributed Queue Dual Bus
<b>IEEE 802.3h-1990 (Clause 5)</b>	10 Mb/s Layer Management, DTEs	<b>IEEE 802.7</b>	BBTAG; Broadband Technical Advisory Group
<b>IEEE 802.3i-1990 (Clauses 13 and 14)</b>	10 Mb/s UTP MAU, 10 BASE-TP	<b>IEEE 802.8</b>	FOTAG; Fibre Optic Technical Advisory Group
<b>IEEE 802.3j-1993 (Clauses 15-18)</b>	10 Mb/s Fibre MAUs 10BASE-FP, FB and FL	<b>IEEE 802.9</b>	ISLAN; Integrated Services LAN
<b>IEEE 802.3k-1993 (Clause 19)</b>	10 Mb/s Layer Management, Repeaters	<b>IEEE 802.10</b>	SILS; Standard for Interoperable LAN Security
<b>IEEE 802.3l-1992 (14.10)</b>	10 Mb/s PICS proforma 10BASE-T MAU	<b>IEEE 802.11</b>	WLAN; Wireless LANs
<b>IEEE 802.3m-1995</b>	Maintenance 2	<b>IEEE 802.12</b>	DPAP; Demand Priority Access Protocol
<b>IEEE 802.3n-1995</b>	Maintenance 3	<b>IEEE 802.14</b>	CATV; LANs in Cable Television Networks
<b>IEEE 802.3p-1993 (Clause 20)</b>	Management, 10 Mb/s Integrated MAUs	<b>IEEE 802.15</b>	WPAN; Wireless Personal Area Networks
		<b>IEEE 802.16</b>	BWA; Broadband Wireless Access
		<b>IEEE 802.17</b>	RPR; Resilient Packet Ring
		<b>IEEE 802.18</b>	RRTAG; Radion Regulatory Technical Advisory Group

# ■ NORM-GLOSSARY

<b>IEEE 802.19</b>	CTAG; Coexistence Technical Advisory Group	<b>DIN EN 60068-1</b>	Environmental tests - Part 1: General and guideline (IEC 60068-1:1988 + Corrigendum 1988 + A1: 1992)
<b>IEEE 802.20</b>	MBWA; Mobile Broadband Wireless Access	<b>DIN EN 60068-2-2</b>	Environmental tests - Part 2: Tests; Test group B: Dry heat (IEC 60068-2-2:1974 + IEC 68-2-2A:1976 + A1:1993)
<b>Important standards for network components and network environments DIN EN</b>		<b>DIN EN 60068-2-6</b>	Environmental tests - Part 2: Tests; Test Fc: vibrations, sinusoidal (IEC 60068-2-6:1995 + Corrigendum 1995)
<b>DIN EN 50081-1</b>	Electromagnetic compatibility (EMC) Generic standards: emission standard; Part 1: residential, commercial and light industrial environments	<b>DIN EN 60068-2-14</b>	Environmental tests - Part 2: Tests; Test N; temperature change (IEC 60068-2-14:1984 + A1:1986)
<b>DIN EN 50082-1</b>	Electromagnetic compatibility (EMC) Generic standards: emission standard; Part 1: residential, commercial and light industrial environments	<b>DIN EN 60068-2-27</b>	Environmental tests - Part 2: Tests; Test Ea and guideline: Shocks (IEC 60068-2-27:1987)
<b>DIN EN 50098-1</b>	Information technology cabling of building complexes - Part 1: ISDN basic connection	<b>DIN EN 60068-2-30</b>	Environmental tests - Part 2: Tests Db and guideline: moist heat, cyclic (12+12 hours cycle) (IEC 60068-2-30:1980+A1:1985)
<b>DIN EN 50173-1</b>	Information technology - application-neutral communication cable systems, general requirements and office environments (cf ISO/IEC 11801)	<b>DIN EN 60068-2-32</b>	Environmental tests - Part 2: Tests: Test Ed: free falling (IEC 60068-2-32:1975+A1:1982 +A2:1990)
<b>DIN EN 50173-2</b>	Information technology - application-neutral communication systems, residential (cf ISO/IEC 11801) (SOHO area)	<b>DIN EN 60603-7-3</b>	Connectors, shielded up to 100 MHz
<b>DIN EN 50173-3</b>	Information technology - application-neutral communication systems, industrial (cf ISO/IEC 11801)	<b>DIN EN 60603-7-5</b>	Connectors, shielded up to 250 MHz
<b>DIN EN 50174-1</b>	Information technology - installation of communication cabling - Part 1: Specification and quality assurance	<b>DIN EN 60603-7-7</b>	Connectors, shielded up to 600 MHz
<b>DIN EN 50174-2</b>	Information technology - installation of communication cabling - Part 2: Installation planning and practices in buildings	<b>DIN EN 60794-3</b>	Fibre optic cables - Part 3: pipeline, underground and aerial cables: generic specification (IEC 60794-3:1998)
<b>DIN EN 50174-3</b>	Information technology - installation of communication cabling - Part 3: Installation planning and practices outdoors	<b>DIN EN 60811-1-1</b>	Insulation and sheathing materials for cables and insulated conductors - General test method - Part 1-1: General application; measuring the wall thickness and the external dimensions; method for determining the mechanical properties (IEC 60811-1-1:1993 + A1:2001)
<b>DIN EN 50288-4-1</b>	Multicore metallic data and control cables for analogue and digital transmission - Part 2-1: Generic specification for shielded cable up to 600 MHz; cables for the horizontal and vertical area	<b>DIN EN 60825-2</b>	Safety of laser equipment - Part 2: safety of fibre optic cable communication systems (IEC 60825-2:2000)
<b>DIN EN 50288-4-2</b>	Multicore metallic data and control cables for analogue and digital transmission - Part 2-2: Generic specification for shielded cable up to 600 MHz; device connection cables and switchboard cables	<b>DIN EN 60950</b>	Safety of information technology equipment
<b>DIN EN 50288-2-1</b>	Symmetric cable, shielded up to 100 MHz	<b>DIN V ENV 61000-2-2</b>	Electromagnetic compatibility (EMC) Part 2-2: Environmental conditions; main section 2: Compatibility level for low frequency cable propagated interference factors and signal transmission in public low voltage networks (IEC 61000-2-2:1990, modified)
<b>DIN EN 50288-5-1</b>	Symmetric cable, shielded up to 250 MHz	<b>DIN EN 61000-3-2</b>	Electromagnetic compatibility (EMC) Part 3-2: Limits for harmonic current emissions (equipment Input current up to and Including 16 A per conductor) (IEC 6100-3-2:2000, modified)
<b>DIN EN 50288-4-1</b>	Symmetric cable, shielded up to 600 MHz	<b>DIN EN 61000-4-1</b>	Electromagnetic compatibility (EMC) Part 4-1: Test and measuring methods; Overview of the series IEC 61000-4 (IEC 61000-4-1:2000)
<b>DIN EN 50310</b>	Application of measures for potential equalisation and earthing in buildings with information technology equipment	<b>DIN EN 61000-4-2</b>	Electromagnetic compatibility (EMC) - Part 4: Test and measuring methods - Main section 2: Interference resistance to static electricity discharge - EMC Basic standard (IEC 61000-4-2:1995)
<b>DIN EN 55022</b>	Information technology equipment - radio interference properties . thresholds and measuring methods (IEC/CISPR 22:1997, modified + A1:2000)	<b>DIN EN 61000-4-3</b>	Electromagnetic compatibility (EMC) Part 4-3: Test and measuring methods; Testing the interference resistance against high frequency magnetic fields (IEC 61000-4-3:2002)
<b>DIN EN 55024</b>	Information technology equipment - interference resistance characteristics - thresholds and test methods (IEC/CISPR 24:1997, modified)		

# ■ NORM-GLOSSARY

<b>DIN EN 61000-4-4</b>	Electromagnetic compatibility (EMC) - Part 4: Test and measuring methods - Main section 4: Testing the Interference resistance against fast transient electrical interference factors/Burst-EMC Basic standard (IEC 61000-4-4:1995)	<b>IEC 1156-2</b>	Generic specification for floor cables
<b>DIN EN 61000-4-5</b>	Electromagnetic compatibility (EMC) - Part 4: Test and measuring methods - Main section 5: Testing the interference resistance against surge voltages (IEC 61000-4-5:1995)	<b>IEC 1156-3</b>	Generic specification for patch and device connection cables
<b>DIN EN 61000-4-6</b>	Electromagnetic compatibility (EMC) - Part 4: Test and measuring methods - Main section 6: Cable-propagated interference factors, induced by high frequency fields (IEC 61000-4-6:1996)	<b>IEC 1156-4</b>	Generic specification for building connection and vertical cables
<b>DIN EN 61000-6-1</b>	Electromagnetic compatibility (EMC) Part 6-1: Generic standards - immunity for residential, commercial and light industrial environments (IEC 61000-6-1:1997, modified)	<b>EN ISO/IEC</b>	DIN EN ISO/IEC 9314-3 Information processing systems - distributed data interface with fibre optics (FDDI) - Part 3: Medium-specific specifications for the bit transmission layer (PMD) (ISO/IEC 9314-3:1990)
<b>DIN EN 61000-6-2</b>	Electromagnetic compatibility (EMC) Part 6-2: Generic standards; interference resistance for industrial environment (IEC 61000-6-2:1999, modified)	<b>ISO/IEC</b>	ISO/IEC 11801 Information technology - application-neutral site cabling (cf EN 50173) 2nd edition 2003 ISO/IEC 24702
<b>DIN EN 61000-6-3</b>	Electromagnetic compatibility (EMC) Part 6-3: Generic standards; Generic standard Interference emission for residential, commercial and light industrial environments (IEC 61000-6-3:1996, modified)	<b>DIN VDE</b>	DIN VDE 0100-540 Erection of power installations with rated voltages up to 1000 V; selection and setting up electrical equipment; earthing, earth conductor, potential equalisation conductor
<b>DIN EN 61000-6-4</b>	Electromagnetic compatibility (EMC) Part 6-4: Generic standards; Generic standard interference emission for industrial environment (IEC 61000-6-4:1997, modified)	<b>UL</b>	UL 508 Industrial Control Equipment; Standard for Safety UL 1604 Industrial Control Equipment for Use in Hazardous Locations
<b>DIN EN 61131-2</b>	Programmable Logic Controllers - Part 2: Equipment requirements and testing (IEC 61131-2:1992)	<b>UL 60950</b>	Safety of Information Technology Equipment
<b>DIN EN 187000</b>	Generic standard specification; Fibre optic cable	<b>Germanischer Lloyd</b>	Germanischer Lloyd; Classification and construction regulations, VI-7-3-Part 1
<b>DIN EN 187101</b>	Family specification: Fibre optic telephone, underground and pipeline cables	<b>CENELEC-Normen</b>	European guidelines, in Europe "normative" (CENELEC is the European committee for electronic standardisation)
<b>DIN EN 188000</b>	Generic specification: Fibre optics	<b>EN 50173</b>	describes the performance requirements for the application-neutral cabling system
<b>DIN EN 188100</b>	Generic specification: Single mode fibre optics	<b>HD 608</b>	Generic specification of the symmetric data cable for message transmission
<b>DIN EN 188101</b>	Family specification: Non-dispersion-shifted single mode fibre optic cables (Type B1:1)	<b>EN 50167</b>	Generic specification for shielded floor cables
<b>DIN EN 188201</b>	Family specification: Multimode fibre optic cables - Category A1a	<b>EN 50168</b>	Generic specification for shielded patch and device connection cables
<b>DIN EN 188202</b>	Family specification: Multimode fibre optic cables - Category A1b	<b>EN 50169</b>	Generic specification for shielded building connection and vertical cables
<b>IEC</b>	IEC 60096-1 High frequency cables; Part 1: General requirements and measurement methods IEC 60793-2 Fibre optics - Part 2: Product specification	<b>EN 55022</b>	(concerning EMC). Contains limits and methods for measuring radio interference for information technology equipment.
<b>IEC 60793-2</b>	Fibre optics - Part 2: Product specification	<b>Note</b>	In the standards EN 50167 EN 50168 and EN 50169 data cables with shielding and halogen-free outside covering are specified
<b>IEC 60794-2</b>	Fibre optic cables; Part 2: Indoor cables - product specification		
<b>IEC 60874-10</b>	Connectors for fibre optics; Part 10: Generic specification; Fibre optics connector Type BFOC/2,5 (ST)		
<b>IEC 1156-1</b>	Generic specification of the symmetric data cable for message transmission		

# ■ GLOSSARY

<b>10 Base FX</b>	Standard for 10 Mbit/s Ethernet data transfer on fibre optic cables. Every connection is made using two fibres, one fibre for "send data" and another one for "receive data".	<b>Alignment</b>	Optimal positioning of the ends of the optical fibre for splice connections (splicing). When connecting single-mode fibre optics, the alignment of the fibres is made with the LID system.
<b>10 Base T</b>	Standard for 10 Mbit/s Ethernet data transfer on twisted pair cables. Every connection is made using two pairs of cores, one pair for "send data" and another one for "receive data".	<b>Analogue signal</b>	Signal whose information parameter can take any of many values within technically specified limits. Theoretically an infinite resolving capacity, however limited practically.
<b>100 Base FX</b>	Standard for 100 Mbit/s Ethernet data transfer on fibre optic cables. Every connection is made using two fibres, one fibre for "send data" and another one for "receive data".	<b>Analogue signal</b>	A physically measurable value (such as a voltage for example), modifiable in frequency and amplitude for information transfer.
<b>100 Base TX</b>	Standard for 100 Mbit/s Ethernet data transfer on twisted pair cables. Every connection is made using two pairs of cores, one pair for "send data" and another one for "receive data".	<b>ANSI</b>	American National Standards Institute promotes and manages industry standards
<b>1000 Base FX</b>	Standard for 1000 Mbit/s Ethernet data transfer on fibre optic cables. Every connection is made using two fibres, one fibre for "send data" and another one for "receive data".	<b>APC</b>	Advanced Process Control - advanced methods of process control. They imply model predictive control (MPC) rules, fuzzy control, KNN and softensors. APC methods are used particularly in the process industry. In chemical mass production for example, they are used for controlling reactors, distillation columns, centrifuges and coupled systems and for the optimal control of starting, loading and product change procedures. Critical process factor fluctuations can be reduced, faults can be rectified more quickly and thus raw material and energy consumption can be minimised and output and product quality can be increased.
<b>1000 Base TX</b>	Standard for 1000 Mbit/s Ethernet data transfer on twisted pair cables. Every connection is made using two pairs of cores, one pair for "send data" and another one for "receive data".	<b>API</b>	Application Programming Interface - interface which the applications use for communication.
<b>Absorption</b>	The weakening (loss) of radiation when passing through material. A part of the radiant energy of light is converted, for example, to heat.	<b>Appartus</b>	Equipment, device, machine, tool, mechanism. For the purpose of the EMC law, an apparatus is an end product with an independent function, its own enclosure and if needed interfaces and connections for the functional and proper power supply integration in its usage environment.
<b>Access protocol</b>	Access method. Regulates access to the medium. Ethernet: CSMA/CD ; Token-Ring: Token; FDDI: Append Token; WLAN: CSMA/CA	<b>Application Layer</b>	Application Layer - layer 7 of the OSI reference model. Applications access network services. Services are provided which support the applications, e.g. software for data transfer.
<b>Account</b>	Account	<b>Arcnet</b>	Real-time capable field bus for industrial high-speed applications, especially for networking intelligent units, e.g. for communication between controllers or PLC systems with PC applications.
<b>ACL</b>	Agent Communication Language - communication language for information exchange between agents.	<b>ARP</b>	Address Resolution Protocol requests the associated MAC address via the IP address.
<b>ACR (attenuation to crosstalk ratio):</b>	The ACR value shows the difference between near-end crosstalk and wave attenuation. The value should be as large as possible.	<b>AS</b>	Active star coupler
<b>Active components</b>	In electrical engineering: Conductors and conductive parts of operating materials which are usually earthed when live.	<b>AS</b>	Australian Standard
<b>Active redundancy</b>	Action for increasing system availability. During fault-free operation, all of several available system components are involved in performing the function. In the case of failure, the intact components take over the task of the defective components.	<b>ASI</b>	Actuator Sensor Interface - bus systems for the lowest automation level. Enables the simple connection of sensors, actuators and integrated systems to the first control level.
<b>Actuator, actor</b>	Control components, e.g. adjustment motor, switch coupling, power switch for accessing the process, i.e. for using information for influencing material or energy flows in a well-controlled object.	<b>ASIC</b>	Application Specific Integrated Circuit
<b>ADM</b>	User Association DIN-Messbus.	<b>ASN.1</b>	Abstract Syntax Notation One. Programming language of the MIB
<b>ADSL</b>	Asymmetric Digital Subscriber Line - digital subscriber connection line with asymmetrically distributed bandwidth from and to the subscriber.	<b>ASRS</b>	Automatic Storage and Retrieval System - automatic high bay warehouse
<b>AFNOR</b>	Association Française de NORmalisation (France)	<b>ASTM</b>	American Standard of Testing Materials (USA)
<b>Aging</b>	Process for updating data, special address storage. After expiry of a time period, an address is flagged as "old" and is deleted on the next cycle if it has not been detected at a port by then.		

# ■ GLOSSARY

<b>ATM</b>	Asynchronous Transfer Mode. Based on cells of 53 bytes. Suitable for telephone, video and other data transfer. Mainly used in WAN applications.	<b>Bandwidth</b>	As well as the attenuation, the bandwidth is the second parameter for designating the properties of a fibre optic cable. The bandwidth represents a measure of the dispersion behaviour of a fibre optic cable.
<b>Attenuation</b>	Reduction of the signal output between two cross section areas of a fibre. It is dependent on the wavelength: Main causes: Dispersion, absorption. Its unit of measure is "dB", specified as $10 \log P(L1)/P(L2)$ .	<b>Bandwidth</b>	Amount of data which can be transferred within one second. For an individual connection, this is analogous to speed, e.g. 10 Mbit/s, 100 Gbit/s.
<b>Attenuation coefficient</b>	This is the attenuation of the cable in relation to the length in stationary condition (unit: dB/km or dB/100 m)	<b>Batch-Processing</b>	Batch-Processing - processing a quantity of objects in a defined sequence, e.g. a list of requests, instructions or other data to be transmitted.
<b>Attenuation</b>	Damping	<b>Baud rate</b>	Measure for the number of symbols transferred per second. Also called symbol rate, symbol speed or step speed. Unit = baud. If a symbol is only represented by one bit [0 or 1], the baud rate corresponds to the bit rate. If a symbol has several bits, the bit rate is larger than the baud rate.
<b>AUI</b>	Attachment Unit Interface. Interface for physical separation of transceivers from Ethernet controllers.	<b>BDM</b>	Basic Drive Module: includes the converter part and the drive specific controller and regulation.
<b>Auto negotiation</b>	A process defined in Fast Ethernet using which the participants agree a common transfer mode before the actual data transfer (100 Mbit/s or 10 Mbit/s, Full Duplex or Half Duplex)	<b>Bending radius</b>	Smallest radius which the conductor can be bent without additional attenuation.
<b>Auto negotiation</b>	Detects the transfer parameters such as speed, duplex mode, flow control at the port of the connected device and sets the optimal values accordingly.	<b>BFOC</b>	Bayonet Fibre Optical Connector. Also known as ST connector. Fibre optic connector with bayonet connection. Standardised as the only connector for 10 Mbit/s Ethernet. Also available for multi-mode and single mode glass fibres and for POF.
<b>Autocrossing</b>	Automatic crossover of the send and receive lines at twisted pair interfaces is possible with this function. Participants, e.g. switches, which support this function can be connected with each other using a straight through cable instead of a crossover cable.	<b>BGP</b>	Border Gateway Protocol Routing Protocol in the WAN.
<b>Automatic machine</b>	An automatic machine, derived from the Greek "automatos" = self-moving, from the technical realisation perspective is every piece of equipment which automatically runs an intended process after fulfilling specified start conditions after the granting of the start command.	<b>Binary signal</b>	Signal whose information parameter can only take two values.
<b>Automation</b>	Application of technology, using which operating equipment completely or partially performs specified operations according to preset programs without human intervention.	<b>Bit</b>	Binary Digit - binary position, binary character, binary number. Basic unit for information in digital transfer systems (0/1, On/Off).
<b>Automation pyramid</b>	Classically consists of five levels: field level (sensor / actuator), control level (process control, forming production cells), HMI level, MES level, ERP level	<b>Bit rate</b>	Number of bits which are transferred within a time unit. Measure for the transfer speed of binary data.
<b>AWG</b>	American Wire Gauge, a unit for wire diameter. Back scattering technique a method for measuring length, reflection and attenuation curve in a data cable. A small proportion of the signal is reflected to the sender and evaluated.	<b>bit serial</b>	The individual bits of a character are transferred one after the other in time on a single line.
<b>Backbone (-network)</b>	Connects several LAN or WAN networks to a large network.	<b>BITBUS</b>	Field bus based on standard technologies such as RS485 and SDLC. Easy to use communication system.
<b>Backpressure</b>	Simulates a collision in HDX mode by generating a jam signal.	<b>BLP</b>	Bandwidth length product
<b>Balun</b>	Device for joining balanced (the currents are equal in magnitude and opposite in phase such as twisted pair) and unbalanced (one side is connected to earth and the other carries the signal such as coax) lines, but also for resistance transformation (wave resistance adaptation).	<b>BOOTP</b>	Bootstrap Protocol. Provides the statically assigned IP address to a given MAC address.
		<b>BPDU</b>	Bridge Protocol Data Unit. Signalisation packet between switches, used for spanning tree.
		<b>bps</b>	Bits per second: Measure for data transfer speed.
		<b>Bridge</b>	A device which connects two LANs with each other.
		<b>Broadcast telegram</b>	Broadcast to all network participants.
		<b>BS</b>	British Standard (UK)
		<b>BSI</b>	British Standards Institute (UK)



# ■ GLOSSARY

<b>BT</b>	Bit time. Duration of a bit.	<b>CATV</b>	Community Antenna Television (International)
<b>Buffered fibre cable</b>	Consists of several loose fibres in a common sleeve.	<b>CC-Link</b>	Control & Communication Link - field bus system which makes high- speed communication up to 10 Mbps possible between the field equipment.
<b>Building automation</b>	Computer based control, observation and monitoring of all relevant functions for the operation or use of one or several buildings, e.g. heating, ventilation, air conditioning, lighting, ...	<b>CDM</b>	Complete Drive Module - it consists of a so-called Basic Drive Module (BDM) and possible accessories such as power supply equipment for example.
<b>Bundles</b>	The fibres are arranged parallel to each other and joined flat with each other at equal spacing (e.g. directly glued or between two adhesive films). Several bundles can be grouped in stacks in one cable.	<b>CEBEC</b>	Comite Electrotechnique Belge (Belgium)
<b>Bus, Bus system</b>	Basically, a distinction between serial and parallel buses must be made. Serial bus systems (cable bus systems) transfer data bit serial between widely distributed components of a system using a common medium (two-wire or four-wire, coaxial cable, fibre optic cable or radio waves) and in this way drastically reduce the wiring complexity as compared with a conventional star configuration.	<b>CEE</b>	International Commission on Rules for the Approval of Electrical Equipment (international commission)
<b>BV</b>	Bureau Veritas (France)	<b>CEI</b>	Commission Electrotechnique Internationale (International)
<b>Byte</b>	Data format or unit for characterising information quantities and storage capacities. 1 byte = 8 bits. Common multiples: kB, MB, GB	<b>CEMP</b>	Centre d'Etude des Matières Plastiques (France)
<b>Cable</b>	Means for transferring signals. It consists of one or several electric conductors insulated from each other in a common sleeve installed in the cable covering.	<b>CEN</b>	Comité Européen de Normalisation (European Committee for Standardisation)
<b>Cable core</b>	The whole of the stranded elements present in the cable and the wrapping over all these elements.	<b>CENELEC</b>	Comité Européen de Normalisation Electrotechnique (European Committee for Electrical Engineering Standardisation) Responsible for the harmonisation of electrical engineering standards in the European Union.
<b>Cable covering</b>	Sheath, generally made of polyethylene (PE), polyvinyl chloride (PVC) or halogen-free material (H) which protects the cable core from environmental influences.	<b>Channel</b>	Connection path between two operating points from and including distribution equipment (e.g. hub) up to and including work place connection cable.
<b>Cable screen</b>	Conductive sleeve of a cable or a conductor for protecting individual cores or the complete stranded elements against electromagnetic influences from the outside.	<b>Central drive technology</b>	Design technique for drive concepts with several motors where the central power supply, the converter, the motor controller, possibly required motor regulators and diverse switching equipment are combined in one switch cabinet.
<b>CAE</b>	Computer Aided Engineering - computer supported planning, design, development and project planning. (computer supported engineering work in the broadest sense)	<b>CiA</b>	CAN in Automation e.V.: International user and manufacturer association founded in 1992. This provides technical, product-specific and general information with the aim of disseminating knowledge about CAN.
<b>Caloric load</b>	Total of the caloric load values of all combustible materials in a room (unit for cable: MJ/m or in kWh/m)	<b>CIP</b>	Control & Information Protocol.
<b>CAM</b>	Computer Aided Manufacturing - computer supported production (production in computer automated manufacturing systems).	<b>Client</b>	A workstation connected to a network, e.g. a PC, which uses the services of a server. The client sends user requests in a special protocol to the server, receives its responses and displays these in legible form on the user's screen.
<b>CAN</b>	Controller Area Network: Serial bus system, car manufacturing, industrial control equipment, design according to ISO 11898 bus medium twisted pair conductor.	<b>Client Server Network</b>	Tasks are clearly divided. The server provides services and the clients use these services.
<b>CAP</b>	Computer Aided Planning - computer supported planning (e.g. of processes, work operations, work sequences, operating material usage etc.).	<b>CLPA</b>	CC-Link Partner Association
<b>CAQA</b>	Computer Aided Quality Assurance - computer supported quality assurance (planning and realisation of the operational quality assurance tasks).	<b>CNC</b>	Computerised Numerical Control.
		<b>CNET</b>	Centre National d'Etude de Télécommunication (France)
		<b>CNOMO</b>	Comité de Normalisation des Moyens de Production (France) - commission for standardisation of tools and machine tools in the French automobile industry
		<b>Coating</b>	A plastic coating applied to the fibre covering surface as mechanical protection.

# GLOSSARY

<b>Coaxial cable</b>	Concentric conductor pair consisting of an inside and an outside conductor which completely encloses the inside conductor. Inside conductor and outside conductor are insulated from each other with a homogenous material or a combination of fixed supporting shells and a gas.	<b>Crosstalk</b>	Interference produced in a neighbouring pair from the usage signal in a wire pair.
<b>Collision domain</b>	For the CSMA/CD access method, the runtime of a data packet from one participant to the other is limited. Dependent on the data rate, this produces a spatially limited network, the so-called collision domain. The maximum expansion of a collision domain is 4250 m for 10 Mbit/s (Ethernet) and 412 m for 100 Mbit/s (Fast Ethernet). Full duplex operation of a connection makes expansion beyond these limits possible as it rules out collisions. The precondition for this is the use of bridges or switches.	<b>Crosstalk</b>	Undesired transfer of energy, e.g. between two neighbouring fibres of a cable.
<b>Compact fibre</b>	A combination of single fibre loose buffer and tight buffered cable. The small hollow space between fibre and sheathing is filled with a non-stick coating.	<b>CSA</b>	Canadian Standards Association (Canada)
<b>Component based automation</b>	New concept at TIA for applications with distributed intelligence. It is based on the new PROFINET standard of the PROFIBUS user organisation (PNO) and supports consequent modularisation using the component technology in machine construction and engineering.	<b>CSMA/CD method</b>	Carrier Sense Multiple Access/Collision Detection - access method for Ethernet according to IEEE 802.3. Each participant checks whether the transfer medium is free before sending a message. (Carrier Sense). Afterwards, it begins to send and simultaneously checks whether other participants (Multiple Access) have also started to transmit data. A collision occurs if two or more participants send at the same time. The participants end their data transmission (Collision Detection). The next attempt for a free line is started after a random time. For the CSMA/CD method, the network expansion is determined by a maximum permissible running time of the data signals on the network which is dependent on the data rate.
<b>Conductor</b>	The conductor is used for forwarding the electrical carriers and thus consists of an electrically conductive material (metal). The conductor is usually round.	<b>CSTB</b>	Centre Scientifique et Technique du Bâtiment (France)
<b>Conductor resistance</b>	The conductor resistance is determined by the quality of the copper used and the conductor cross section. It increases linearly with the length of the cable and is decisive for the attenuation.	<b>Cut-Through</b>	Switching process where a packet is already forwarded after recognition of the destination address. In this way, the latency time is low; however defective packets are also forwarded. Also known as "on the fly packet switching".
<b>Core</b>	The core is a conductor enclosed in an insulation sleeve. The insulation sleeve can be air or any other non-conductive material (usually plastic).	<b>CVI</b>	Complete Vertical Integration: This means the continuous information flow in automated production from the sensors and actuators via the control level to the management level. Its efficient realisation requires that office and factory automation are based on the same information technology platform and that the interfaces between the individual levels are standardised across all manufacturers.
<b>Corrosivity</b>	Produced by corrosive gases and acids when burning cables and wires. Non-corrosive cables should be used for laying in buildings. Halogen-free cables are generally non-corrosive.	<b>Data</b>	Characters or continuous functions which represent information based on known or implied arrangements for processing purposes.
<b>Coupler</b>	Passive component for transferring / branching light to one or several fibres. The arriving optical light power is divided or combined from another view direction.	<b>Data Link Layer</b>	Layer 2 in the OSI reference model: the data packets to be sent are converted unto so-called frames and sent, whereby the receiving side acknowledgement of the frames transmitted is waited for.
<b>Coupling mechanism</b>	Physical mechanism over which electromagnetic interferences, assuming sources affect sinks and based on the electromagnetic interference energy process from source to sink are transferred.	<b>dB</b>	Decibel: Unit which has been used to express the level for logarithmic relationship factors such as transfer factor, amplification factor, attenuation factor as the logarithm of the decimal logarithm. 1 dB 0.115 Np
<b>Coupling resistance</b>	Measurement for the quality of the screening. It is defined as the ratio of the voltage along the screen of the disturbed system to the current of the interfering system.	<b>DCOM</b>	Decentralised Control Systems
<b>CP</b>	Communication Processor - controls the process of the communication protocol between the components of a system	<b>DCS</b>	Digital Communications System
<b>CPU</b>	Central Processing Unit	<b>DCS</b>	Distance Control System
<b>Crimping</b>	A mechanical protection is made by pressing a sleeve around the fibres.	<b>DDL</b>	Device Description Language
		<b>DDR-SDRAM</b>	Double Data Rate SDRAM: new type of memory which uses the rising and the falling edge of the clock signal for data transfer. Read/write speed increases.

# ■ GLOSSARY

<b>Decentralised drive technology</b>	In contrast to centralised drive technology, here only the power supply and parts, if needed, of a central controller are installed in a switch cabinet for drive systems with several motors while all other functional parts such as converters and regulators are installed directly at the location for the individual motors.	<b>DIN Messbus</b>	Bus system designed for the reliable and cost-effective communication of equipment for measuring, monitoring and recording process and operation data. Practically any bus and branching cables, transfer rates 110 bps to 1 Mbps, full duplex operation. Areas of application: production measuring technology, quality assurance, statistical process control, operating and machine data recording and also in conjunction with programmable logic controllers.
<b>Decibel (dB)</b>	Unit for transmission strength, attenuation and output level.	<b>DIS</b>	Draft International Standard
<b>DEMKO</b>	Danmarks Elekriske Materielkontrol (Denmark)	<b>Dispersion</b>	Light impulses in a fibre have time diversification due to the dispersion. Distinctions are made between mode, material and wave dispersion.
<b>DES</b>	Data Encryption Standard	<b>DKE</b>	Deutsche Kommission Elektrotechnik Elektronik Informationstechnik im DIN und VDE. As national organisation for developing standards in electrical engineering and information technology, the DKE ensures important cross section concerns such as safety, EMC, components and performance of classic electricity grids through mobile radio communication up to software and Internet protocols.
<b>DESINA</b>	Decentralised and standardised installation technology for machine tools and production systems (comprehensive overall concept for the standardisation and decentralisation of the fluid technical and electrical Installation of machines and systems).	<b>DMA</b>	Digital Motion Access
<b>Destination address</b>	Destination address for Ethernet.	<b>DMC</b>	Digital Motion Control
<b>Device Description</b>	DD - Device Description: it provides an expanded text description of every individual device in the virtual field device.	<b>DNS</b>	Domain Name System. Translates host names to IP addresses via DNS server or statically with the "hosts" file.
<b>DeviceNet</b>	Simple CAN-based communication system for networking industrial automation equipment with superordinate controllers. Two twisted pair shielded pairs within a cable are used for transmission. One is used for communication and the other for supplying power to the connected equipment.	<b>Domains</b>	Broadcast domain - network segment only limited by routers where a broadcast spreads freely. Collision domain: Network segment limited by switches or routers where collisions spread freely.
<b>DFÜ</b>	Dial-up connection	<b>DP</b>	Decentralised Periphery (Profibus application layer, layer 7 in the OSI reference model)
<b>DHCP</b>	Dynamic Host Configuration Protocol. On request, communicates its IP address to a device which is permanently allocated via the associated MACaddress or is dynamically granted.	<b>DPI</b>	Dots Per Inch
<b>Dielectric</b>	An electrically non-conductive substance which an electrical field goes through. Increases the capacity of a plate condenser.	<b>DTE</b>	Data Terminal Equipment
<b>Dielectric constant</b>	Dielectric value. Substance-specific constant for the polarisability factor of the substance. The higher the dielectric constant of a dielectric the higher the capacity of the corresponding condenser.	<b>Duplex connector</b>	Two fibre optic connectors combined with a clip or their design which are usually used as send and receive line.
<b>Digital signal</b>	A digital signal has several information parameters, e.g. 8, 16, 32 or 64, which are provided one after the other chronologically for serial signals and in parallel chronologically for parallel signals. The 1/0 coded representation of information such as digits and letters or the bit patterns from analogue signals (sounds, images, videos, measurement values etc) produced by scanning and quantisation.	<b>DVMRP</b>	Distance Vector Multicast Routing Protocol. Internetwork Gateway Protocol, largely based on RIP. DVMRP uses IGMP to exchange routing datagrams with its neighbours.
<b>Digital/Analogue converter</b>	Functional unit which converts a digital signal to an analogue signal.	<b>DWDM</b>	Dense Wavelength Division Multiplex
<b>DIN</b>	Deutsches Institut für Normung	<b>EANTC</b>	European Advanced Networking Test Centre.
<b>DIN rail</b>	Support rail, construction element for simple mounting of modules. As well as the mechanical support function, support rails are very often used as PE collecting bars.	<b>Earth</b>	In the context of electrotechnical matters, this means the more or less good electrically conductive earth which shows no potential differences outside the influence range of earth connections or other electrical phenomena.
		<b>Earth conductor</b>	Conductor which connects the body of an apparatus to be earthed with an earth connector or several earth connectors provided this conductor is insulated in the earth or laid outside it.
		<b>EC Motors</b>	Electronically Commutated Motors - electronic motors

# GLOSSARY

- EFAC** European Factory Automation Committee
- EIA** Electronic Industries Alliance (USA)
- EIA** Electronic Industries Association
- EIB** European Installation Bus
- EIBA** EIB Association
- Elastomer** Materials which can be reversibly expanded to at least double their starting length and have a low elasticity modulus and high recoil elasticity.
- Electric motors** are electromechanical energy converters which can operate as motor and generator i.e. driving and braking.
- Electromagnetic interference** Irradiation of interference during signal transmission caused by electromagnetic fields.
- ELM** Electrical Link Module
- EMC** Electromagnetic compatibility is the capability of an electric apparatus to operate satisfactorily in its electromagnetic environment without abnormally influencing this environment (which also includes other equipment) or itself being influenced by it.
- EMC** Electromagnetic compatibility RFI immunity and emissions behaviour, Class A/B.
- EMC Directive Cable** European Commission Electromagnetic Compatibility Directive 89/336/EC. Plays a role in passive cabling in conjunction with the active components. Therefore, shielded systems should be used exclusively for information technology cabling.
- EMC Directive, general** Basic requirements for electromagnetic compatibility are specified in this new EMC Directive which equipment must comply with so that it can be placed on the market and put into service. "Equipment" is the higher level concept for the objects included in the Directive, which on the one hand are "apparatus" and on the other hand "stationary systems". For the purposes of the Directive, equipment also means components and assemblies installed in a device by the end user and mobile systems, which are defined as a combination of devices and other components which can be operated at various locations. Stationary systems in the new EMC Directive also includes large machines, high-voltage systems, electricity grids and telecommunication networks. These must be designed according to the recognised technology regulations, however do not require a conformity assessment before being put into service.
- EN** European Norm
- Encoder** Coder, encrypter - in information technology, an encoder is a hardware or software based system for converting data in order to convey a certain amount of information faster over a slow transport path for example, or to require less storage space for archiving. In both cases, the information content remains the same, but the amount of data is reduced. Afterwards, at the other end of the line or after reading the stored data, the reverse procedure is required in order to restore the original data format. This is done using a decoder. An encoder is called a rotary encoder in industrial automation. This is an electromechanical precision device which converts analogue angle values at the input side on its shaft as compared with a reference point into electric digital output signals. Encoding A mechanical device on a connection system which ensures a non-reversed connection or prevents the insertion of a plug into a socket of the same connector type, i.e.. switched to a different use.
- EPC** Electronic Product Code - electronic numbering system for physical objects such as, e.g. products, pallets, packets, individually packaged goods and also livestock.
- EPDM** Ethylene Propylene Diene Monomer - synthetic rubber Produced by polymerisation.
- EPSG** Ethernet Powerlink Standardisation Group
- ESD** Electrostatic Discharge
- ETG** EtherCAD Technology Group
- EtherCAT** Ethernet for Control and Automation Technology. Ethernet solution for industrial automation. Thanks to the optimal usage of the Ethernet bandwidth, small quantities of data can also be transferred efficiently with EtherCAT. Extremely short cycle times and high transfer performance are the result. For example, any 1,000 distributed digital I/Os can be queried with EtherCAT in 30 µs with reading and writing in full duplex. 50 µs are needed for 200 analogue values and 100 axes are checked in 100 µs. EtherCAT is particularly suitable for fast PCbased control technology. The master does not need any special plug-in card and can be implemented with a very simple interface on any available Ethernet controllers. EtherCAT is also well suited for small and medium control technology and will also open up completely new application areas for distributed I/Os there.
- Ethernet** Based on the CSMA/CD access method. Coaxial cable or twisted pair wires are used as transfer medium. Widely used technology for networking computers in a LAN. Ethernet technology has generally established itself in the office environment.
- Ethernet-Powerlink** is an expansion of the standard Ethernet. It enables data exchange under hard real-time conditions with cycle times down to 200 µs and jitter of less than 1 µs. Thus, Ethernet can be used in automation technology on all communication levels from the control level to the I/Os.
- Ethernet/IP** Ethernet Industrial Protocol

# ■ GLOSSARY

<b>EtherNet/IP</b>	Protocol stack for Ethernet which has been developed for industrial applications. It is based on the standard TCP/IP protocol and uses a common application layer with DeviceNet. It this makes information exchange between device level networks and information systems at the operating level easier.	<b>Field bus barrier</b>	Device for increasing the number of field bus participants in the Ex-area.
<b>ETSI</b>	European Telecommunication Standards Institute	<b>FIP</b>	Factory Implementation Protocol or Flux Information Process
<b>Factory automation</b>	Factory Automation	<b>FITL (Fiber In The Loop)</b>	FITL (Fibre In The Loop) Fibre in the local connection network. The following are distinguished depending on the end point of the fibre path: FTTB Fibre to the building; FTTC Fibre to the curb / kerb; FTTH Fibre to the home; FTTD Fibre to the desk
<b>Failure rate</b>	Measure for the failure behaviour of system units (e.g. components). The proportion of failures per time period with respect to the total number of a system quantity is designated as the failure rate.	<b>Flame resistance</b>	Description of the behaviour of products against fire propagation
<b>FAN</b>	Field Area Network - field bus system: Network for real-time capable exchange of data and information between automation components, equipment and power units inside the technology area of systems.	<b>Flame retardant</b>	Flame retardant, i.e. fire propagation in the case of fire is delayed (FR)
<b>FAR</b>	Federal Air Regulation	<b>Frequency</b>	Number of complete oscillations per second (in Hz)
<b>Fast Ethernet</b>	100 Mbps transfer rate	<b>Frequency converters</b>	are devices based on power electronic semiconductor components which operate in switched mode, i.e. only in the on-state or in the off-state. Especially in variable speed alternating current drive systems, they have the task of producing a usually three-phase modifiable frequency and voltage amplitude for feeding the rotary motor from a single or three phase mains alternating current constant frequency and amplitude.
<b>FCS</b>	Frame Check Sequence. Checksum at the end of the Ethernet packet; calculated and recorded by the sender. The recipient calculates the checksum based on the packet received and compares this with the value entered.	<b>FRNC</b>	Flame retardant and non corrosive
<b>FDDI (Fiber Distributed Data Interface)</b>	FDDI (Fibre Distributed Data Interface) Fibre optic network with dual opposite ring topology and 100 Mbit/s transfer rate. The FDDI is fault tolerant to cable or node failure.	<b>FTP</b>	File Transfer Protocol: Rules for transferring data from one computer via a network to another computer. The protocol is based on TCP/IP which has established itself as quasi standard for data transfer via Ethernet networks. FTP is one of the most used protocols on the Internet. It is defined in RFC 959 in the official regulations for Internet communication.
<b>FDIS</b>	Final Draft International Standard	<b>FTP</b>	1. File Transfer Protocol. Protocol on Layer 5, uses TCP for transport, therefore usage in WAN 2. Foiled Twisted-Pair.
<b>FDMA</b>	Frequency Division Multiple Access - multiple access in the frequency multiplex	<b>FTTD</b>	Fibre To The Desk
<b>FDT</b>	Field Device Tool: industry standard created by ZVEI and PNO, which makes the integration of measuring and automation equipment in the process and system control systems easier.	<b>FTZ</b>	Fernmeldetechnisches Zentralamt
<b>FDX</b>	Full duplex - transfer mode of a component: sending and receiving is possible simultaneously. No access method is necessary.	<b>Full duplex</b>	Data transfer process in which information is transmitted simultaneously in both directions.
<b>FEXT</b>	A form of crosstalk where signals from participants on the opposite side of a twisted pair line overlap.	<b>Full duplex operation (two-way transfer)</b>	Information transfer in both directions on one fibre.
<b>FF</b>	Field bus Foundation	<b>GARP</b>	Generic Attribute Registration Protocol. Protocol family for exchanging parameters between switches on Layer 2 gateway device for connecting two networks which have different protocols.
<b>Fibre core</b>	Core of a glass fibre with a higher refractive index than the cladding glass.	<b>Gbit</b>	GigaBit, 109 Bit
<b>Fibre multiplex</b>	Transmission method where one fibre is assigned to each transmission channel.	<b>Gbps</b>	Gigabits per second
<b>Fibre optics</b>	Transparent dielectric waveguide for transferring electromagnetic waves in the visible light range. Conductor based on glass fibre or plastic fibre; not sensitive to electromagnetic interference.	<b>Gigabit Ethernet</b>	Fast data network specified in 1999 in IEEE 802.3
<b>Field bus</b>	Bus system near the process for direct connection of sensors and actuators with their own intelligence. Small quantities of data are transferred in digital form between sensors, actuators and controller on a field bus.	<b>Glass cladding</b>	The glass enclosing the core of a glass fibre; the cladding glass has a lower refractive index than the core glass.
		<b>GMA</b>	VDE/VDI-Gesellschaft Mess- und Automatisierungstechnik
		<b>GOST</b>	USSR-Standards

# ■ GLOSSARY

<b>Graded index fibre</b>	The graded index fibre is a fibre optic cable with a graded index profile	<b>Hybrid cable</b>	Consists of at least two different types of cable (e.g. fibre optic and copper cables) in a common sleeve.
<b>Graded index profile</b>	Fibre whose refraction index profile decreases parabolically from the inside to the outside across the cross section of the core surface.	<b>IAONA</b>	Industrial Automation Open Networking Alliance: Alliance of leading international automation equipment manufacturers for dissemination of open network standards such as Ethernet as world wide standard for industrial communication.
<b>GRP Element Gradientefaser</b>	Antibuckling and strength, ember made of glass filaments (GRP: Glass Reinforced Plastic).	<b>ICMP</b>	Internet Control Message Protocol. Most well-known command: Ping.
<b>Half duplex</b>	Operating mode, where a device can either send or receive data. Ethernet collision detection is active for half duplex. The network expansion is limited by the runtime delays of the equipment and transmission media.	<b>ID</b>	Identifier
<b>Half-life</b>	(A radionuclid) is the time in which the activity is reduced by half.	<b>IDA</b>	Interface for Distributed Automation. Open interface on top of the TCP/IP stack for automation applications.
<b>Halogen-free</b>	No halides (e.g. chlorine) in use. Halogen-free cables are used for increased fire protection requirements with respect to protection of persons or on account of high material concentration. In the case of fire they release noncorrosive gases and the released quantity of toxic gases is significantly lower than for PVC materials.	<b>IEA</b>	International Ethernet Association - association for promoting the use of industrial Ethernet
<b>HCS</b>	Half duplex - transfer mode of a component: either sending or receiving is possible.	<b>IEC</b>	International Electrotechnical Commission
<b>HD</b>	Harmonisation Document (international)	<b>IEE</b>	Institution of Electrical Engineers (Great Britain)
<b>HID</b>	Human Interface Devices - user interfaces: any device for interaction between human and computer.	<b>IEEE</b>	Institute of Electrical and Electronics Engineers
<b>HMI</b>	Human Machine Interface	<b>IETF</b>	Internet Engineering Task Force.
<b>HN</b>	Harmonisation des Normes (France)	<b>IFG</b>	Inter Frame Gap. minimum gap between two packets.
<b>Hollow core</b>	Consists of a fibre and a loose sleeve enclosing it.	<b>IGMP</b>	Internet Group Management Protocol. Layer 3 protocol for multicast transport.
<b>Horizontal Integration</b>	Connects the MES solutions with each other in an enterprise pyramid. In this way, all information is available online and multiple data entries and doubled data retention are avoided.	<b>IGP</b>	Interior Gateway Protocol.
<b>HRTS</b>	Hard Real-Time System - system that is able to meet hard real-time requirements.	<b>IGRP</b>	Interior Gateway Routing Protocol.
<b>HSE</b>	High Speed Ethernet Industrial Ethernet solution of the Fieldbus Foundation FF	<b>Impedance</b>	Impedance of the electrical quadripole; it is composed of the ohmic resistance and the reactance, the frequency-dependent resistances and capacitances. The impedance is constructively specified by the dimensions of the internal conductor, dielectric and shielding.
<b>HSLAN</b>	High Speed LAN: local network with transfer rates around 100 Mbps and higher.	<b>Indoor cable</b>	Cable for applications inside buildings. They are not suitable for laying outdoors.
<b>HTML</b>	Hyper Text Markup Language - programming language with hypertext links. Language used for most Websites.	<b>Industrial Ethernet</b>	Designation for Ethernet in automation technology. Due to the industrial usage environments, the network components must comply with expanded temperature ranges and increased requirements with respect to the reliability and safety of the network.
<b>HTTP</b>	Hyper Text Transfer Protocol - data transfer protocol for the transfer of HTML pages and the files of all kinds linked to them. It is the protocol on which the whole World Wide Web is based; this means it regulates the interaction between Web browser and Web server. It is active for every mouse click on a hyperlink and ensures that the browser is provided with the respective next piece of desired information.	<b>Insertion loss</b>	For assessment of the transfer quality of a plug connector, its insertion loss is taken into account, i.e. it is determined what amount the attenuation of an optical transmission path increases when a plug connection is inserted into this transmission path.
<b>Hub</b>	Central connecting device in a network with star topology which distributes arriving data packets to all connected end devices.	<b>Insulation resistance</b>	It is determined by the insulation material whereby the material properties are more significant than the insulation thickness. The insulation resistance is dependent on the length. The higher the specific resistance of a material, the more suitable the material is for insulation; the unit is [m]; for cables and wires, the derived units [Mkm] or [Gkm] are common.

# ■ GLOSSARY

<b>INTERBUS</b>	Bus system which is designed from its technical characteristics specially for use with industrial sensors/actuators and continuous networking from the controller level right up to the last limit switch.	<b>L-PAS</b>	The video image evaluation L-PAS (Lens Profile Alignment System) is a system for splice process control. The ends of the fibres to be spliced are constructed with one or several CCD cameras. The video signal is used on the one hand for displaying the fibres on the monitor and for controlling the fibre positioning and on the other hand for the splice attenuation assessment.
<b>Interface</b>	Intersection point at which two different systems are connected for the purpose of data transfer.	<b>LACP</b>	Link Aggregation Control Protocol.
<b>Interface</b>	From the hardware standpoint, an interface identifies the connection point between two assemblies/devices/systems.	<b>LAN</b>	Local Area Network: spatially limited system for high speed information transfer between a limited number of independent terminals with equal rights.
<b>Inteference</b>	Fault, adverse effect, reduction of functionality	<b>LAN</b>	Local Area Network e.g. Ethernet, FDDI and Token Ring
<b>Interference resistance</b>	Ability of a device, of a unit or of a system to operate without reduction of functionality in the presence of electromagnetic interference.	<b>LAP</b>	Link Access Protocol.
<b>Intrinsic safety</b>	Protection class of explosion proof electrical equipment. This is achieved in the course of designing this equipment by limiting the energy in the intrinsic electrical circuits.	<b>LASER</b>	Light Amplification by Stimulated Emission of Radiation: Amplifier for electromagnetic waves in the visible light spectrum.
<b>IP</b>	Internet Protocol : protocol according to which the data within a network, e.g. in the Internet or intranet reach one computer from another. Every computer present in the network is uniquely identified by its IP address.	<b>Latency</b>	Delay time
<b>IP Adress</b>	Internet Protocol address: numeric address which is assigned to a computer in the Internet and which makes it uniquely identifiable. It consists of a sequence of four groups of numbers, each with maximum three digits, separated by periods.	<b>Latency time</b>	Period of time needed by a device to react to an input event at the output or also the time which, e.g. a data packet needs to traverse a network from sender to recipient or how long it remains in a network device before it is forwarded.
<b>IP protection classes</b>	They characterise the protection of electrical equipment by enclosure, cover or casing and in fact the protection of persons against access to dangerous parts inside the cover and protection against the ingress of foreign bodies and water.	<b>Launch angle</b>	Angle between the propagation direction of the light occurring and the optical axis of a fibre optic cable. In order for the light occurring to be couples, this angle must be between zero and a maximum value which depends on the location on the front surface of the thread or on its local refraction difference as compared with the switching.
<b>IPC</b>	Industrial PC	<b>Lay-length</b>	The axial length along the centre axis of a cable according to which a stranding element is wrapped completely (360°) once around the axis.
<b>ISDN</b>	Integrated Services Digital Network. A digital network in which all types of data such as, e.g. voice, text or images are transmitted to and from the participant via a single line.	<b>LCIE</b>	Laboratoire Central des Industries Electriques (France)
<b>ISDN</b>	Integrated Services Digital Network. WAN transfer protocol.	<b>LED</b>	Light Emitting Diode
<b>ISO</b>	International Standards Organisation: world wide federation of national standards institutions from more than 130 countries.	<b>LID-System (Local Injection and Detection System)</b>	The LID system provides highly precise positioning of the fibres in the x/y and z directions. It consists of two bending couplers (sender and receiver). The light is coupled into the fibres on the sending side. The transmitted light power is measured at the receiving side. Criterion for the optimal alignment of the fibres is the maximum of the light power transmitted over the splice.
<b>ISO/OSI</b>	OSI reference model	<b>Light speed</b>	v0 2, 998 x 10 <sup>8</sup> m/sec
<b>ITU-T</b>	International Telecommunication Union, Telecommunication Standardisation Sector Standardisation Committee	<b>Light waves</b>	Electromagnetic waves in the optical frequencies range. The term "light" originally referred to the visible radiation with the human eye with a wavelength between 400 and 800 nm. However, it is also common to describe radiation in the adjacent spectral ranges (e.g. infrared) as light.
<b>Jabber</b>	Defective frames for Ethernet with more than 1518 bytes.	<b>Link</b>	Connection path between two nodes from and including the distribution patch panel up to and including the work place connection socket.
<b>Jitter</b>	Term for time fluctuations of cyclic events.		
<b>KB</b>	Kilobyte -> 1 KB = 210 or 1024 bytes		
<b>kbps</b>	Kilobits per second		
<b>KEMA</b>	Keuring van Elektrotechnische Materialen (Netherlands)		

# ■ GLOSSARY

<b>Link Aggregation</b>	Combination of several ports (max, 4) into one virtual port. Parallel connection transfer with redundancy if a port fails. Standard IEEE 802.3. Commonly called "Trunking".	<b>MIB</b>	Management Information Base. Contains the description of the connected objects and functions in a network.
<b>LON</b>	Local Operating Network: open bus system which makes possible the interaction of components from different manufacturers.	<b>Microbending</b>	Bending of a fibre which produces light losses and thus attenuation increases.
<b>Loop resistance</b>	Ohmic complete resistance from transmit and return conductors (unit: W/km)	<b>Migration</b>	Process of porting data or software to a different technical platform
<b>Low Voltage Directive</b>	The aim of the directive is to ensure the safety of the consumers. It concerns all electrical equipment for generating, transmitting, distributing, storing electrical energy, e.g. generators, cables, switches, sockets and many others, for use with a rated voltage between 50 and 1,000 Volts for alternating current and between 75 and 1,500 Volts for direct current. Exceptions are regulated in Appendix II of the Directive. Such equipment, according to the Directive, is only allowed to be brought into circulation if it is manufactured according to the state of safety technology specified in the European Union, it does not endanger people, productive livestock and property during proper installation and maintenance and during proper use, it has been subjected to a conformity assessment procedure by the manufacturer, there is a corresponding declaration of conformity and it is marked with the CE marking.	<b>MII</b>	Media Independent Interface
<b>LSOH</b>	Low smoke and halogen-free (LS = low smoke) (OH = zero halogen)	<b>MIL</b>	Military Specification (USA)
<b>LWL</b>	Fibre optics	<b>MLPPP</b>	Multi Link PPP. See also PPP.
<b>MAC</b>	Medium Access Control	<b>MMI</b>	Man Machine Interface
<b>Machine</b>	According to the Machines Directive, a machine means a totality of parts, at least one of which is moveable, connected with each other. As well as the mechanical components, operating, control and energy components also belong to the machine.	<b>MMS</b>	Man Machine Interface (MMI)
<b>MAN</b>	Metropolitan Area Network (large area network, e.g. connection of several LANs within a city).	<b>MODbus</b>	Master / Slave network which makes it possible, for example, for a master computer to communicate with one or several PLCs or Remote I/Os, to perform program processes, data transfers or other operations.
<b>MAP</b>	Manufacturing Automation Protocol - data transfer protocol for automated manufacturing.	<b>Modem</b>	Device which converts the signals from one form into another in order to make the compatibility with another system.
<b>Master</b>	Central bus participant which regulates the bus access. All other participants operate as slaves.	<b>Modes</b>	All waveguides capable of propagation in a fibre optic cable
<b>Master/Slave Concept</b>	Master element determines, slave element follows the instructions of the master. For example, an automation device as master element grants the access rights for the other components for the decentralised bus controller.	<b>Motion Control</b>	Motion control
<b>MC</b>	Motion Control	<b>MPLS</b>	Multiprotocol Label Switching. Layer 3-Protocol.
<b>MDI</b>	Medium Dependent Interface	<b>MSB</b>	Most Significant Bit.
<b>MDI-X</b>	MDI-Crossover	<b>MTBF</b>	Mean Time Between Failure.
<b>Meshed structure</b>	Every participant is connected with several others. Several independent transmission paths can exist between two stations. This redundancy can be used for assurance of the data transport if there is an interruption of one transmission path.	<b>Multi-vendor system</b>	in such a system, the problem-free collaboration of automation components from different manufacturers is made possible based on manufacturer-neutral communication media and transfer protocols.
		<b>Multicast</b>	Data packet which is destined for a group of devices, e.g. to all Hirschmann equipment.
		<b>Multicast telegramm</b>	is sent to a group of defined recipients. This group can be reached using one address.
		<b>Multimode fibre</b>	Fibre optic cable whose core diameter is large in comparison with the wavelength of the light so that two or more modes are capable of propagation.
		<b>Multiplexing</b>	Combination of two or several information channels on a common transfer medium.
		<b>Multistage profile</b>	Fibre with a sharp drop of the refraction index between core and cladding, whereby the refraction indexes of core and cladding in themselves remain constant. Transmitting width: The frequency at which the amount of the transfer function of a fibre optic cable has dropped to a specified value. The transmitting width of a fibre optic cable is approximately reciprocal to its length.
		<b>NAT</b>	Network Address Translation
		<b>NC</b>	Numerical Control



# ■ GLOSSARY

<b>NEC</b>	National Electrical Code (USA)	<b>OLP</b>	Optical Link Plug: Bus component, slave connection, industrial communication.
<b>NEMA</b>	National Electrical Manufacturers Association (USA)	<b>OPC</b>	OLE for Process Control. Protocol in process automation for the standardised data exchange between Windows applications.
<b>NEMKO</b>	Norges Elektriske Materiekkontroll (Norway)	<b>Open Systems</b>	An Open System is not sectioned off, but has active connections to its environment, i.e. it can exchange material, energy and information flows with its environment. According to IEEE, an open technical system provides the precondition for the portability of applications to many platforms from different manufacturers, the ability for the collaboration of different applications and for a consistent appearance to the user. This requires the manufacturer-neutral free choice of software and hardware components based on uniform and standardised interfaces and the simple configurability of application-specific system options according to the plug and play principle.
<b>NEN</b>	Nederlands Normalisatie Instituut (Netherlands)	<b>Operating capacity</b>	Effective line capacity
<b>NetBEUI</b>	NetBIOS Extend User Interface. Extended version of the NetBIOS protocol which is used by network software such as LAN Manager, LAN Server, Windows for Workgroups and Windows NT.	<b>Operation control level</b>	Level at which the relevant decisions for operation management are made. The occurrence of technical and organisation data from various areas is characteristic. The required communication system can range over several enterprise components or premises.
<b>Network</b>	Connection structure made up of individual elements which are connected with each other and/or which have a defined interaction with each other (road networks, electricity supply grids, communication networks)	<b>OSI</b>	Open Systems Interconnection. International standardisation programme, established by ISO and ITU-T in order to create standards for data networks which ensure the compatibility of equipment from different manufacturers.
<b>Network</b>	System with the associated transfer method that is supported by message coding cabling.	<b>OSI reference model</b>	Has been presented by the ISO with the objective of making it possible to connect networks from different manufacturers with different topologies. The OSI reference model thereby describes a standard which classifies and specifies according to which principles the communication, using various protocols, between the components to a network takes place. Altogether, it consists of seven Layers: Physical Layer; Data Link Layer; Network Layer; Transport Layer; Session Layer; Presentation Layer and Application Layer.
<b>Network Layer</b>	Layer 3 in the OSI reference model: The data packets are addressed here and logical names and addresses are converted into physical ones and the transmission paths are determined.	<b>OTDR</b>	Optical Time Domain Reflectometer. Measuring apparatus.
<b>NEXT</b>	Near End Crosstalk, in dB, calculated from the power ratio of the wanted signal power to the interference signal power at the same end of the cable.	<b>OUI</b>	Organisationally Unique Identifier. The first three bytes of the MAC address identify the manufacturer of the component.
<b>NF</b>	Normes Françaises (France)	<b>Outdoor cable</b>	Cables which are constructed so that they are sufficient for all requirements such as those which occur for underground and pipeline cable systems.
<b>NFC</b>	Normes Françaises Class C (France)	<b>ÖVE</b>	Austrian Association of Electrotechnique
<b>NIC</b>	Network Interface Card. network interface in the computer.	<b>P-NET</b>	Field bus for process automation. The electrical specification of P-Net is based on the RS-485 standard and uses a shielded two-wire cable. This allows cable lengths up to 1,200 m without repeaters.
<b>NMS</b>	Network Management System	<b>Packet size</b>	Frame size
<b>Node</b>	Branching point in a network.		
<b>Node</b>	Participant in the data network, e.g. computer, printer, hub, switch, ...		
<b>NRZ</b>	Non Return to Zero. Signal code.		
<b>NVP</b>	Nominal Velocity of Propagation - reduction factor of a data cable in [%] as compared to a line with a dielectric constant of 1 of the insulating material (air). Among other things, it is used for calculating the runtime (e.g. NVP 77 % produces a runtime of approx. 0.33 / NVP 4.2 ns/m).		
<b>ODVA</b>	Open DeviceNet Vendor Association: independent organisation which supports the further development, use and dissemination of DeviceNet world wide.		
<b>ODVA</b>	Open Device Vendor Association - is an organisation which promotes the world wide dissemination of DeviceNet and EtherNet/IP network technologies and standards in industrial automation.		
<b>OLE</b>	Object Linking and Embedding - is a technology for transferring various data between devices.		
<b>OLM</b>	Optical Link Module: Bus component for the construction of fibre optics networks and the transition from copper conductors to fibre optic cable.		

# ■ GLOSSARY

<b>Parallel Detection</b>	Partial function of auto negotiation in order to adjust to a partner which does not support auto negotiation. A port detects the speed due to FLP or NLP and adjusts accordingly to 100 Mbit/s or 10 Mbit/s. HDX is always used as duplex mode.	<b>Potential equalisation</b>	Electrical connection which brings the bodies of electrical equipment and external conductive parts to approximately the same potential.
<b>PAS</b>	Process Automation System	<b>Power switch</b>	Circuit breaker, mechanical switch hat can switch on the current under proper operating conditions, carry this without time limit and switch off, which can also under defined extraordinary conditions, e.g. short-circuit currents, switch on, carry for a specified time and switch off.
<b>Patch cable</b>	Flexible connection cable for connecting two components e.g. in a distribution cabinet.	<b>Presentation Layer</b>	Presentation layer: Layer 6 in the OSI reference model: This layer determines the text formatting and display. Furthermore, it is responsible for data security. It also makes data compression possible.
<b>PB</b>	Petabyte -> 1PB = 250	<b>Pressure sensor</b>	Measuring element which converts the physical pressure factor into an output factor proportional to the pressure.
<b>PD</b>	Powered Device - describes the end device in the draft of the IEEE P802.3af standard. IEEE 3af defines how a power supply can be done using an Ethernet twisted pair cable.	<b>Primary cabling</b>	A connection of the individual building distributors on the works premises.
<b>PDU</b>	Protocol Data Unit	<b>Priorisierung</b>	Prioritisation Data packets are processed in priority order according to defined criteria.
<b>PFM</b>	Plant Floor Machinery - production system	<b>Process</b>	Process, procedure or sequence in which time continuous or discontinuous quantitative or qualitative modification of the parameters and/or the status of a real or virtual observation object or medium are ensured.
<b>PHY</b>	Physical sublayer. Physical layer / component.	<b>Process automation</b>	In the context of the given explanations of process and automation, this generally means the use of technical equipment resources for the automatic execution of any processes.
<b>Physical Layer</b>	Layer 1 in the OSI reference model: Bit transfer layer, lowest level, electrical and mechanical specifications for cables and network adapters are defined and also the mode for how the bits are sent via the cable.	<b>Process industry</b>	Designation for industrial sectors in whose systems there are technical processes running, i.e. those in which the material, bulk goods or energy flows involved in the main process are treated or processed continuously or discontinuously such as, for example, in chemical large systems, in pharmaceutical industry systems, steel production and cement manufacturing, foodstuffs, semi-luxury food and drinks industry, and in waste incineration plants, foundries and others.
<b>Pigtail</b>	Short piece of fibre optic cable for coupling components where one end has a connector and the other end is spliced.	<b>Process optimisation</b>	The processes running in technical systems are always operated with the objective, taking account of certain given conditions, of achieving the best possible process result.
<b>PIMF</b>	Pair in metal foil.	<b>Product bandwidth length</b>	This describes the effect that the bandwidth of a given product is inversely proportional to its length. The product bandwidth length is usually stated in Mhz x km or GHz x km.
<b>PLC</b>	Programmable Logic Controller - calculation based control device whose functionality is specified by a so-called application program.	<b>Product bandwidth length</b>	Used for estimating the distance supported by a multimode fibre for a specified data rate (speed). Thereby, the gross rate must be used, e.g. 125 Mbit/s for Fast Ethernet.
<b>PLS</b>	Process control system	<b>Production automation</b>	Automation market segment for the industrial areas of circuit, assembly, component, device and power unit production.
<b>PLT</b>	Process control technology	<b>PROFIBUS</b>	Process Field Bus
<b>Plug connection</b>	Easily removable connection with plugs. The insertion loss of a plug connection is usually higher than the transfer loss of a splice connection.		
<b>PMD</b>	PROFInet Machine Distributor: central signal distributor with individual connections to all terminal equipment of the network.		
<b>PMD</b>	Physical Medium Dependent. Physical Layer / Component on Level 1a.		
<b>PNO</b>	Profibus Nutzerorganisation (Profibus User Organisation)		
<b>POF</b>	Polymer Optical Fibre - designation for a fibre optic cable whose optical core and sheath are made using plastic. POF fibres have a typical core diameter of 0.98 mm.		
<b>Point-to-point structure</b>	All participants are on a common transmission path. Only one message can be transported from one station to another at a time.		
<b>Polling</b>	Method for synchronisation during the data transfer. During polling one partner queries the master and the other slaves cyclically whether they want to send something or can receive something.		
<b>Port-Mirroring</b>	The data traffic of one port is mirrored at a different port in order to, for example, examine this with an analyser.		

# ■ GLOSSARY

<b>PROFIBUS-DP</b>	Profibus for the area of “decentralised peripherals”. Simple digital and analogue input / output components and intelligent signal and process data processing units can be relocated locally and thus, among other things, significantly reduce costs for the cabling complexity. Mainly for time-critical applications in production automation.	<b>RARP</b>	Remote Access System.
<b>PROFIBUS-FMS</b>	Profibus Fieldbus Message Specification: Field bus for use at the system level with relatively low real-time requirements, industry standard.	<b>RAS</b>	Remote Access System.
<b>PROFIBUS-PA</b>	Process Field Bus for Process Automation	<b>Real-time</b>	A system operates in real-time or is capable of real-time operation if it accepts input factors in a defined time period, processes these and provides the results in good time for a partner system or the system environment.
<b>PROFINet</b>	Open component-based industrial communication system based on Ethernet for distributed automation systems. Load-bearing components are the object-oriented modelling of systems and their functional parts based on COM, runtime communication based on TCP/IP and DCOM and manufacturer-independent engineering concept for the system project planning of a PROFINet system with a graphical circuit diagram editor. Technology promoted and supported by PNO.	<b>Real-time classes</b>	The real-time requirements for calculation, control, regulation and communication systems are determined by the partner systems they interact with.
<b>Profinet CbA</b>	Solution for distributed decentralised intelligence. Standardised module specification. Open communication between modules. Engineering with drag and drop.	<b>Real-time requirements</b>	Real-time systems have the characteristic of reliably reacting to an external stimulation within a defined time period. As regards compliance with the time limitation, a distinction must be made between hard and soft real-time requirements. Hard real-time requirement: if all required system responses to an external stimulation must be made absolutely reliably within a fixed, specified time period. Soft real-time requirement: if exceeding a specified time limit can be tolerated to a certain extent.
<b>Profinet IO</b>	Direct connection of decentralised field equipment to Ethernet is possible.	<b>Real-time system</b>	System which responds to an external event within a specified time period. The focus here is not absolutely on speed. Rather, the necessary reaction speed depends on the environment or partner object which the system is co-operating with in a concrete application. For example, fast digital regulations require real-time systems whose reaction times are in microseconds; on the other hand, automation solutions with programmable logic controllers have reaction times in milliseconds, and for slower systems in the process industry, e.g. temperature regulations, reaction times in seconds or even minutes are sufficient. As regards compliance with the time limit, a distinction must be made between hard and soft real-time requirements. There is a hard real-time requirement if all required system responses to an external stimulation must absolutely be made reliably under all possible conditions within a fixed, specified time period, otherwise there is a risk of serious damage. On the other hand, there is a soft real-time requirement if exceeding a specified time limit can be tolerated to a certain extent as no serious consequences are to be expected. The real-time capability of a system is itself dependent on many influencing factors. Especially for automation technology, signal running times, cycle times, latency times, jitter, synchronicity requirements and the data throughput play a significant role.
<b>Profinet IRT</b>	Isochronous Real Time: is hardware supported real-time communication with isochronous data transfer.		
<b>ProfiSafe</b>	Safety profile: allows the transfer of safety-integrated and standard data on one bus line.		
<b>Proprietary</b>	Property rights assigned		
<b>Protocol</b>	Series of procedures for making and controlling a communication.		
<b>PSE</b>	Power Sourcing Equipment - describes the power providing device in the draft of the IEEE P802.3af standard. IEEE 3af defines how a power supply can be done using an Ethernet twisted pair cable.		
<b>PVV</b>	Path Variability Value. Expressed in bit times.		
<b>QoS</b>	Quality of Service. Quality of the transfer, e.g. speed, bandwidth, latency, safety or priority. Only realised for priority on Layer 2 in IEEE 802.1D.		
<b>Quadro Star</b>	Strand element which consists of four wires twisted with each other whereby the respectively opposite wires form a transmission path (trunk). Front surface coupling (star surface coupling) Signal transfer via fibre ends connected at the front.	<b>Receiver</b>	Assembly for converting optical signals to electrical signals. It consists of a photo diode which converts the incoming optical signal into photocurrent which is amplified afterwards in a (low-noise) amplifier; if needed there are other downstream electronic circuits, e.g. decoder, for the signal preparation.
<b>Queue/Queuing</b>	Generally describes the queue of elements or tasks. A queue in a data transfer system is a queue of messages or data packets which are waiting for further processing or forwarding. They are sorted temporarily and processed one after the other using a corresponding queuing method.	<b>Redundancy</b>	Abundance, excess, surplus
<b>RAM</b>	Random Access Memory. Volatile memory.	<b>Reflection</b>	Reflection of rays (waves) at border surfaces between two different substances.

# ■ GLOSSARY

<b>Refraction</b>	Direction change made by an electromagnetic wave (e.g. light) when it passes from one material into another and there is a large difference in the refraction index for both materials.	<b>RS232</b>	Recommended Standard Number 232, the oldest and most widely used interface standard, also called V.24 Interface; all signals are related to earth so that it is an unbalanced to ground interface.
<b>Refraction index</b>	The factor at which the light speed in an optical medium (e.g. glass) is smaller than in a vacuum.	<b>RS422</b>	Recommended Standard Number 422; balanced to ground operation, thus higher interference resistance. High Level: 2 -6 V; Low Level: +2...+6 V; four-wire connection
<b>Reinforcement</b>	Protection element (usually made of steel wires or belts) used for cables with special usage conditions such as for use at sea and in mines.	<b>RS485</b>	Recommended Standard Number 485; expanded interface standard as compared with RS422; High Level: 1.5 -6 V; Low Level: +1,5...+6 V; two-wire connection -> half duplex operation or four-wire connection -> full duplex operation.
<b>Repeater</b>	Repeater, amplifier - apparatus for amplifying and regenerating signals and a network. It can cover larger distances. Simple, economic means of extending a LAN.	<b>RSVP</b>	Resource Reservation Protocol. reserved bandwidths in the WAN.
<b>Repeater</b>	Component for signal regeneration on level 1. Regenerates amplitude, signal edge and clock signal. Repeaters with more than two ports are called hubs.	<b>RTCP</b>	Real-time Transport Control Protocol.
<b>Resistance difference</b>	Difference of the ohmic resistance between two cores of a cable (unit W)	<b>Rx</b>	Receive
<b>Return loss</b>	Measure for matching systems; when the correct termination resistance of a cable (wave resistance) is selected, the reflection factor is 0 and thus also the return loss.	<b>SA</b>	Source Address
<b>RG58</b>	Coaxial cable with 50 Ohm wave resistance. Also called Thin Wire or 10BASE2.	<b>SAE</b>	Society of Automotive Engineers
<b>Ring structure</b>	All participants are connected with each other in a ring. There is no centre. All participants have equal rights.	<b>SafetyBUS</b>	Field bus system for serial transfer of safety-related information. Safety systems and products such as light barriers, safety door and emergency stop circuits can thus be safely and decentralised connected with each other.
<b>RIP</b>	Routing Information Protocol - for exchanging routing information between routers in the LAN. There are two versions: RIP V1 and RIP V2.	<b>SAN</b>	Storage Area Network - network for connecting servers and storage subsystems such as discs, RAID and tape systems. Usually based on Fibre Channel.
<b>RJ45</b>	Connector for twisted pair.	<b>SC</b>	Straight Connector. Connector.
<b>RMON</b>	Remote Monitoring.	<b>Screen</b>	Cable structural element for shielding. The design of the screen depends on whether protection against electrical fields (capacitive coupling) or against magnetic fields (inductive coupling) or both is aimed for. The screen material against magnetic fields should always have high electrical conductivity and low inductivity which is why copper is usually used for the conductor.
<b>Rotary encoders</b>	Are small electromechanical precision devices which convert the angle positions of a mechanical shaft which they are connected to into coded data which can be evaluated electrically. They are also called angle sensors, angle encoders and angle coders. Basically, a distinction between incremental and absolute systems must be made.	<b>SDLC</b>	Synchronous Data Link Control - synchronous data transfer procedure
<b>Rotary field magnets</b>	are alternating current asynchronous motors with squirrel cage rotor which are designed for permanent standstill operation. This means they are thermally dimensioned so that they can remain switched on at the rated voltage with a fully braked shaft and thereby develop their greatest torque.	<b>Secondary cabling</b>	Internal building connection of the building distributor with the individual floor distributors. (Backbone).
<b>Rotary magnets</b>	are electromagnetic actuators with and without return springs activated by direct or alternating current which enable limited angle movements. They are used for demanding applications in automation technology.	<b>Segmentation/ Network segmentation</b>	Provides the limit of collision domains and enables a performance improvement of Ethernet networks. The network segmentation is achieved using, e.g. switches.
<b>Router</b>	Component on Layer 3 of the ISO/OSI reference model. Connects networks on Layer 3. Using additional routes to the destination, it provides a choice of routes depending on definable criteria such as route costs.	<b>SEK</b>	Svenska Elekriska Kommissionen (Sweden)
		<b>Selfcentering effect</b>	The selfcentering effect is the striving caused by the surface tension of the melted glass by the glass fibre to form an homogenous, preferably not offset connection.
		<b>SEMKO</b>	Svenska Elekriska Materielkontrollanstalten (Sweden)

# ■ GLOSSARY

<b>Sensor</b>	Apparatus which converts a physical factor based on a physical effect into an electric, pneumatic or hydraulic signal for further processing. These sensors are used in automation technology to obtain necessary information for process execution. For example, the recording of power unit and machine statuses or for recording process data such as temperature, pressure, speed, filling level, flow rate, paths, angles etc.	<b>Smoke density</b>	Measure for smoke development when burning a cable. Attention should be paid to a low smoke density for laying in buildings (typical value: 50%).
<b>SERCOS Interface</b>	Serial Real-time Communications Standard Interface - digital drive position. Communications standard for precise Motion Control applications, e.g. for information exchange between a CNC controller and digital servo drives and decentralised I/Os. Enables very fast and precise real-time communication between a master and several slaves using a fibre optic cable.	<b>SMTP</b>	Simple Mail Transfer Protocol. Internet protocol which provides email services.
<b>Servomotors</b>	Electric motors for activating mechanical components, for example valves or for position-controlled return or positioning of mechanical axes in machine tools, robots and in many other applications.	<b>SNAP</b>	Subnetwork Access Protocol.
<b>Session Layer</b>	Session layer / communication control layer in the OSI reference model, Layer 5: This allows using two applications on different computers and ending them again. It realises the dialogue management, regulates the length of the data transfer and takes care of which participant sends or receives when, and the session synchronisation and the recreation of sessions after a failure	<b>SNMP</b>	Simple Network Management Protocol
<b>SETI</b>	Sähkötarkastuslaitos (Finland)	<b>SNV</b>	Schweizerischer Normenverband
<b>SEV</b>	Schweizerischer Elektrotechnischer Verein (Switzerland)	<b>SOHO</b>	Small Office Home Office. Networks for small offices / branches and teleworkers
<b>Shield</b>	Screening which should prevent the transfer of interference signals, e.g. those from electrical fields for data cables, usually braided with aluminium or copper.	<b>Spanning Tree</b>	Protocol which automatically resolves network loops. When switches are installed, effects redundant paths for additional security in the case of a connection failure. Changeover time 30s to 60s.
<b>Signal</b>	Time-modifiable physical factor, e.g. a voltage or a current, which has a parameter that gives concrete information about further processing of a different physical factor.	<b>Splice</b>	A permanent cable connection, e.g. a splicing of two fibres for fibre optic cables.
<b>Shielding attenuation</b>	Measure of the reduction or attenuation of the electromagnetic field strength at a point in the room, caused by inserting an electromagnetic shield between the field source and this point; usually expressed in dB.	<b>Splitter</b>	Optical component for dividing the light output from one onto several fibres.
<b>Single mode fibre</b>	Fibre optic cable whose core diameter is so small in comparison with the wavelength of the light that only one mode is capable of propagation.	<b>SQE</b>	Signal Quality Error. Signal returned to the LAN controller from a transceiver to communicate whether the packet has been sent correctly. Also called heartbeat.
<b>Skin Effekt</b>	The tendency of alternating current to flow on the surface of a conductor as the frequency increases (reduction of the effective conductor cross section and thus increase of the electrical resistance).	<b>SRS</b>	Safety Requirements Specification: it forms the starting point for the development of safe systems.
<b>Slave</b>	Participant in a network which can only participate in data transfer after being approached by the master.	<b>SRTS</b>	Soft Real-Time System - real-time system which can only meet soft real-time requirements.
<b>SLIP</b>	Serial Line Internet Protocol. Standard protocol for serial point-to-point connections, uses serial interface for IP traffic.	<b>Star coupler</b>	Active or passive component which ensures a uniform light output distribution for an equally large number of incoming and outgoing fibres.
<b>Slotted core cable</b>	Cable where the fibres are in grooves made in the surface of the central element.	<b>Star topology</b>	All participants are connected to a central node. Every communication runs via this node. Direct communication between the participants is not possible.
		<b>Store &amp; Forward</b>	Switching process where a packet is first completely stored and then forwarded.
		<b>STP</b>	Shielded Twisted Pair.
		<b>STQ</b>	Shielded Twisted Quad.
		<b>Switch</b>	Device, similar to a hub, which forwards received data packets in a network in contrast to a hub not to all network nodes but only to the respective addresses. This means, that in contrast to a hub, a switch looks after targeted communication within a network which only plays back a message between sender and receiver. Network nodes not involved are not affected.
		<b>Switched Network</b>	Designation for an Ethernet network which is constructed with switches.
		<b>System</b>	Interconnection of apparatus, systems or electrical or electronic components at a given location. These components perform a specific task with each other.
		<b>System part (unit)</b>	Consists of various devices. Each device usually contains one or more instrument loops which operate in parallel with each other. Examples: pump, compressor, pipeline, ...

# ■ GLOSSARY

<b>System safety</b>	Avoidance of dangerous operating conditions in process systems or their environment. This often concerns avoidance of the risk of explosion.	<b>Transport Layer</b>	Layer 4 in the OSI reference model: is responsible for the correct provision of data. For this, it converts the flow of transmission data into small data packets for the transfer or when receiving converts the data packets back into a data stream. This layer is also responsible for sending acknowledgements. The main tasks are thus the creation and dismantling of participant connections and the safe transfer of the data.
<b>System types</b>	Subdivision in single-purpose systems or single-product systems which are designed for precise manufacture of one product and into multipurpose systems and multiple product systems.	<b>Tree structure</b>	Combination of star structure, point-to-point structure, ring structure and meshed structure
<b>Tag field</b>	Optional field inserted in Ethernet packets after the source data.	<b>Tx</b>	Transmit
<b>TCO</b>	Total Cost of Ownership.	<b>UDP</b>	User Datagram Protocol - network protocol
<b>TCP</b>	Transmission Control Protocol: Protocol which is used together with the Internet Protocol (IP) to transfer data from one computer to another in the Internet.	<b>UL</b>	Underwriters Laboratories. Independent authority in the USA, which carries out product safety examinations.
<b>Tertiary cabling</b>	Horizontal connection of the floor distributor with the connection units at the work place.	<b>UL</b>	Unterwriters Laboratories Inc. (USA)
<b>TGL</b>	DDR-Standards: Technical standards, "Product regulations and delivery conditions" (former German Democratic Republic)	<b>UNI</b>	Unificazione nazionale Italiana (Italy)
<b>TIA</b>	Telecommunication Industry Association. Standardisation Committee	<b>Unicast</b>	Data packet which is only addressed to one recipient, in contrast to multicast and broadcast.
<b>Time multiplex</b>	Transfer process where several pieces of information are transferred simultaneously with different wavelengths on one fibre.	<b>Unsymmetrical to ground/earth</b>	Often also called e-coupling - is the difference between the earthing capacities of both conductors.
<b>Token</b>	Mark, character, sign: Transmission authorisation token in networks with collision-free access	<b>UPS</b>	Uninterruptible Power Supply
<b>Token-Process</b>	Bus access process: during this process, the token is forwarded from one participant to the next. The participant in possession of the token has permission to send and can access the common transfer medium.	<b>UTE</b>	Union Technique de l' Electricité
<b>Topology</b>	The physical or logical structure of network connections and nodes (star ring and bus configuration).	<b>Utility Automation</b>	Automation market segment for the public supply areas of electricity, water/sewerage, pipelines etc.
<b>TOS</b>	Type of Service. Field in the IP packet for prioritisation.	<b>UTP</b>	Unshielded Twisted Pair.
<b>TP</b>	Twisted-Pair. Data cable.	<b>UTQ</b>	Unshielded Twisted Quad.
<b>TPDDI</b>	Twisted Pair Distributed Data Interface.	<b>Validation of Profibus Systems</b>	Guideline which specifies the validation supporting functions in conjunction with the use of Profibus in foodstuffs or pharmaceutical systems.
<b>Traceability</b>	Traceability	<b>VDE</b>	Verband der Elektrotechnik Elektronik Informati-onstechnik e.V.
<b>Transceiver</b>	Transmitter/Receiver - data transmitter/receiver combined in one unit.	<b>VDEW</b>	Vereinigung Deutscher Elektrizitätswerke e.V.
<b>Transfer rate</b>	Speed of the transfer, also bandwidth. Ethernet: 10,100,1000,10000 Mbit/s ; Token-Ring: 4 Mbit/s, 16 Mbit/s ; FDDI: 100 Mbit/s	<b>VDI</b>	Verein Deutscher Ingenieure
<b>Transponder</b>	In measuring and monitoring technology, this means a microchip with a sending and receiving antenna, a control logic and data and energy storage which enables contactless communication with a corresponding reading system.	<b>VDMA</b>	Verband Deutscher Maschinen- und Anlagenbau e.V.
		<b>VDSI</b>	Verband Deutscher Sicherheitsingenieure e.V.
		<b>VLAN</b>	Virtual LAN, constructed with switches. Goal: broadcast limitation to the network area where the broadcast is useful. Is also used for segmenting networks for security reasons.
		<b>VPN</b>	Virtual Private Network. The complete data traffic is encrypted in a VPN for secure transfer via public TCP/IP networks. A VPN uses "tunnelling" in order to encrypt all information at the IP level.
		<b>VRRP</b>	Virtual Redundant Router Protocol. Protocol for controlling redundant routers.

## ■ GLOSSARY

<b>WAN</b>	Wide Area Network Network which includes the connection between elements over a large geographic distance.
<b>Wave resistance</b>	Complex specification factor of the relationship of the wave voltages to the wave currents at every point of the conductor.
<b>Wave length</b>	Length of a complete oscillation (period) of a wave. Three wavelength ranges are usually used in optical message technology. These are 850 nm, 1310 nm and 1550 nm.
<b>Wavelength multiplex</b>	Transfer process where several parallel incoming data signals are transferred on a fibre in one serial data stream.
<b>WDM</b>	Wavelength Division Multiplex.
<b>WFQ</b>	Weighted Fair Queuing. Method for elaborating the priority queues in a switch. The highest priority queue, for example, receives 50% of the bandwidth, the next receives 25%, etc. .
<b>WLAN</b>	Wireless LAN
<b>Work Area cabling</b>	Connection of the connection unit at the work place with the data terminal equipment.
<b>WWDM</b>	The transfer capacity of the optical fibres in fibre optic networks can be increased with the WWDM system. The system multiplexes several optical single mode signals to an optical composite signal. Thus several applications can be transferred simultaneously using one fibre optic cable pair. This makes the installation of additional fibre optic cables unnecessary and this significantly reduces costs.
<b>XML</b>	Extended Markup Language.
<b>ZVEH</b>	Zentralverband der Deutschen Elektrohandwerke e.V.
<b>ZVEI</b>	Zentralverband Elektrotechnik- und Elektronikindustrie e.V.

# Part No. Index

Part no.	Page	Part no.	Page	Part no.	Page
80000 – 80028	51	80436 – 80450	45	80868 – 80894	37
80031	52	80457	304	80895	53
80032 – 80041	51	80473 – 80475	51	80896 – 80908	37
80043	98	80495 – 80518	60	80912 – 80914	51
80045	37	80532	81	80915 – 80959	53
80046 – 80051	51	80534	63	80983	306
80053	90	80576 – 80578	53	80996	299
80055	95	80605	303	81003	166
80068 – 80071	124	80606	304	81036 – 81038	63
80084 – 80116	52	80627	53	81041	304
80118	53	80629 – 80630	81	81043	306
80120 – 80130	52	80631	37	81044 – 81046	304
80131 – 80138	44	80636	306	81050 – 81055	306
80139 – 80146	45	80672	53	81062 – 81070	303
80148 – 80155	44	80681	40	81072 – 81075	302
80156 – 80162	45	80688	35	81077	225
80164 – 80171	44	80691	53	81081	224
80172 – 80178	45	80699	34	81085	227
80180 – 80187	47	80725	40	81108 – 81121	48
80188 – 80195	48	80732 – 80735	53	81123	104
80196 – 80204	47	80743 – 80754	35	81133 – 81136	48
80207 – 80211	48	80759	52	81137 – 81149	52
80212 – 80218	47	80764	51	81155	149
80219	48	80769	35	81186	161
80220	47	80771	52	81202	202
80223 – 80227	48	80774 – 80777	51	81203	204
80264 – 80265	40	80778	202	81209	59
80267	166	80782 – 80791	34	81233	358
80270 – 80281	40	80792	161	81238	75
80294	114	80793	37	81246	37
80305	343	80795 – 80806	35	81254	105
80307 – 80309	308	80809	53	81255 – 81260	59
80316	34	80810	112	81278	99
80363 – 80382	63	80813 – 80821	35	81286 – 81287	190
80384	160	80824 – 80825	207	81302	239
80388	81	80826	225	81320	354
80396	303	80846	41	81354 – 81359	298
80418 – 80435	36	80851	40	81362 – 81365	308



# Part No. Index

Part no.	Page	Part no.	Page	Part no.	Page
81382	48	82434	209	800423 – 800424	306
81446	113	82493	357	800455	343
81447	227	82501	107	800497	218
81448	160	82502	108	800571	195
81478	50	82509	191	800579	75
81495	41	82561	59	800597	348
81501	175	82648	48	800647	121
81557	203	82695	254	800648	163
81609 – 81610	103	82696	204	800649	170
81611	81	82786	59	800650	173
81663	224	82792 – 82803	39	800651 – 800652	219
81675 – 81676	298	82804 – 82818	38	800653	151
81699	120	82821	328	800654	154
81713	169	82822	209	800655	158
81882	81	82824	162	800657	356
81900	34	82835 – 82836	171	800681 – 800682	215
81903 – 81904	174	82838	146	800683 – 800684	214
81905	175	82839	147	800685	195
81906	177	82847	242	800708 – 800710	58
81907 – 81908	216	82848	236	800713 – 800714	328
81909 – 81910	217	82851	242	800715	173
81911 – 81912	199	82852	254	800720 – 800738	303
82008	244	82853	244	800753	60
82010	238	82857 – 82864	247	800754 – 800762	46
82025 – 82026	303	82869 – 82875	298	800800 – 800805	279
82032 – 82033	81	82902	358	800806 – 800811	280
82039	341	82904 – 82909	337	800812 – 800817	281
82040	339	82913 – 800044	167	800818 – 800823	282
82043	340	800067	150	800827 – 800832	269
82047 – 82052	339	800068	144	800833 – 800838	276
82053	342	800088	148	800839 – 800844	273
82055	341	800109	170	800980	77
82058	342	800126	74	800986	283
82097	339	800260	254	801147	115
82190	58	800378	350	801159	240
82390 – 82407	62	800380 – 800381	351	801164 – 801167	298
82408 – 82412	34	800382 – 800383	353	801168 – 801174	299
82431	40	800385	354	801175 – 801178	306

# Part No. Index

Part no.	Page	Part no.	Page	Part no.	Page
801182	60	801414 – 801416	327	802143 – 802145	39
801183	50	801418 – 801420	328	802167	116
801186	352	801421	324	802168	117
801190	42	801425	332	802169	122
801191	179	801465	349	802170	123
801192	180	801471 – 801475	326	802171	91
801193	181	801476	327	802172	92
801194	151	801497	359	802173	101
801195	153	801572 – 801573	193	802174	106
801196	79	801616	41	802177	162
801197	129	801650	153	802178 – 802179	168
801198	80	801651	156	802180 – 802181	172
801200 – 801202	84	801652	205	802182	200
801217 – 801221	42	801659	177	802183	213
801278	262	801674	338	802184	134
801280	83	801686	254	802185	157
801304	321	801687 – 801691	335	802186	159
801305	263	801697	340	802187 – 802188	220
801306	262	801699	342	802207 – 802208	255
801308 – 801309	264	801701	340	802223 – 802231	309
801310	261	801727	63	802247 – 802249	39
801311	260, 321	801733	76	802252	303
801312	263	801754	340	802260	78
801314 – 801315	260, 321	801772	254	802261 – 802276	41
801316	321	801805	340	802277 – 802278	39
801318	283	801832	328	802280	41
801326 – 801331	277	801836	307	802293	145
801332 – 801337	267	801846 – 801847	212	802339	200
801338 – 801341	270	801849	340	802375	357
801342 – 801347	265	801876	338	802376 – 802378	232
801352	67	801878	340	802380 – 802385	245
801354	323	801881	338	802389 – 802394	274
801355 – 801357	325	801982	192	802395 – 802400	268
801365 – 801367	265	802001 – 802004	80	802401 – 802407	285
801378 – 801396	328	802024	235	802410 – 802415	272
801400	352	802025 – 802034	241	802416 – 802422	271
801403 – 801404	355	802073 – 802076	255	802423 – 802429	266
801410 – 801413	326	802131 – 802142	46	802432 – 802437	275

# Part No. Index

Part no.	Page	Part no.	Page	Part no.	Page
802442 – 802444	306	803097 – 803104	249	803925 – 803928	56
802445 – 802452	307	803105 – 803112	250	803929	54
802453 – 802460	298	803113 – 803128	249	803930 – 803932	55
802461	300	803129 – 803144	250	803934 – 803935	64
802462	301	803145 – 803156	298	804043	111
802464 – 802468	278	803157 – 803160	299	804045	100
802469	185	803161 – 803165	306	804051	332
802470	186	803166 – 803176	307	804055 – 804059	335
802471	182	803177	362	804115	206
802482	307	803178	363	804234	283
802495	346	803194 – 803208	285	804244	342
802496	347	803284	58	804254 – 804256	34
802543 – 802545	307	803295	157	804268 – 804269	197
802716	340	803323 – 803326	362	804275 – 804276	62
802764	342	803331	363	804286	233
802792	64	803344	194	804287	245
802793	363	803346 – 803349	65	804299	189
802800	226	803354	178	804300	310
802851	362	803356 – 803357	285	804301 – 804302	311
802908	237	803364	66	804303 – 804307	322
802909	243	803378	109	804408 – 804409	208
802914	158	803379	110	804410 – 804411	210
802916	232	803380	118	804645	232
802917 – 802918	56	803381	119	804646 – 804648	253
802920	283	803382	133	804691	232
802936	310	803383 – 803384	198	804700	65
802985 – 802986	232	803387	141	804705 – 804706	39
802987 – 802988	233	803480	332	804733 – 804744	61
802990	233	803576 – 803577	285	804763	232
802991 – 802998	248	803658 – 803661	55	804766	93
802999 – 803014	247	803664	54	804767	184
803015 – 803030	248	803668	55	804797	56
803033	243	803672	183	804972 – 804977	246
803037 – 803038	49	803693	135	804996	96
803049 – 803056	251	803722	196	805044	232
803057 – 803064	252	803844 – 803845	285	805045 – 805046	307
803065 – 803080	251	803917 – 803920	43	805055	246
803081 – 803096	252	803923 – 803924	49	805057	188

# Part No. Index

Part no.	Page	Part no.	Page
805074 – 805077	307	805690	71
805078 – 805079	306	805691	70
805080 – 805110	304	805692	73
805111 – 805112	303	805693 – 805694	211
805160 – 805161	61	805695	176
805179	94	805696	201
805194 – 805195	286	805697 – 805698	223
805244 – 805247	57	805699 – 805700	142
805287	187	805701 – 805702	143
805381	233	805703 – 805704	136
805401 – 805402	284	805705 – 805706	164
805403 – 805405	233	805709	286
805429	232	805712	306
805445	72	805713 – 805714	307
805548	137	805715	306
805572	102	805716 – 805717	307
805586 – 805587	232	805718 – 805725	304
805588 – 805589	233	805726 – 805730	305
805614	132	805731 – 805733	313
805653	152	805734 – 805736	314
805654	155	805737 – 805741	253
805655	138	805747 – 805749	313, 314
805658	140	805751 – 805752	313, 315
805660	221	805753	314
805661	222	805756 – 805777	316
805662	221	805778	317
805664 – 805671	55	805781 – 805784	284
805672 – 805673	54	805790 – 805801	306
805674 – 805675	55	805802 – 805807	307
805680	130	805838	82
805681	139		
805683	97		
805684	131		
805685	201		
805686	82		
805687	68		
805688	69		
805689	70		















## NOTES

### Technical modifications

© HELUKABEL® GmbH Hemmingen

Specifications have been carefully checked and are believed to be correct; however, no responsibility is assumed for inaccuracies. Subject to technical modifications. Consequently all illustrations, numerical data, etc. are provided without guarantee. Color deviations between photos and delivered goods cannot be avoided. Reproduction or duplication of the text and illustrations, in whole or in part, remain reserved. The transfer of copyrights always requires the written consent of HELUKABEL® GmbH. Our General Terms of Delivery and Payment, which can be viewed at [www.helukabel-group.com](http://www.helukabel-group.com), apply.

### Length markings

The length marking, which cannot be calibrated, is an aid, e.g. for easy material allowance determination or for determination of the length remaining on the drum. Deviation of the line length shown by the marking is up to 1%. Incomplete length markings or length markings missing on sections, deviations of the cable length shown by the length marking do not substantiate any legal obligation whatsoever. Only use calibrated measurement devices to determine line length.

### Safety notice

The cables and wires described in the catalog are produced in accordance with national and international standards, as well as plant standards; application safety, as stipulated in the safety directives, standards, and statutory regulations, as amended, is provided. With the prerequisite of proper and professional installation and use, the possibility of product-specific dangers can be excluded. For each product this catalog describes general information for use. Independent of the above, the applicable DIN VDE specifications apply. However, installation and processing must only be executed by qualified electricians.

**Our General Terms of Delivery and Payment, which can be viewed at [www.helukabel-group.com](http://www.helukabel-group.com), apply**



**HELUKABEL®**

